

**MICROSCAN**

# *Quadrus EZ Reader User's Manual*



---

## *Copyright and Disclaimer*

Copyright © 2007

by Microscan Systems, Inc.,  
1201 S.W. 7th Street, Renton, Washington, U.S.A. 98057  
(425) 226-5700 FAX: (425) 226-8682

ISO 9001:2000 Certification No. 06-1080  
Issued by TÜV USA

All rights reserved. The information contained herein is proprietary and is provided solely for the purpose of allowing customers to operate and/or service Microscan manufactured equipment and is not to be released, reproduced, or used for any other purpose without written permission of Microscan.

Throughout this manual, trademarked names might be used. Rather than put a trademark (™) symbol in every occurrence of a trademarked name, we state herein that we are using the names only in an editorial fashion, and to the benefit of the trademark owner, with no intention of infringement.

### ***Disclaimer***

The information and specifications described in this manual are subject to change without notice.

### ***Latest Manual Version***

For the latest version of this manual, see the Download page on our web site at [www.microscan.com](http://www.microscan.com).  
For technical support email [helpdesk@microscan.com](mailto:helpdesk@microscan.com).

### **Microscan Systems, Inc.**

1201 S.W. 7th Street  
Renton, Washington 98057  
U.S.A.  
Tel: 425 226 5700  
Fax: 425 226 8250  
[helpdesk@microscan.com](mailto:helpdesk@microscan.com)

### **Microscan Europe**

Tel: 31 172 423360  
Fax: 31 172 423366

### **Microscan Asia Pacific R.O.**

Tel: 65 6846 1214  
Fax: 65 6846 4641

## Microscan Limited Warranty Statement and Exclusions

### **What Is Covered?**

Microscan Systems Inc. warrants to the original purchaser that products manufactured by it will be free from defects in material and workmanship under normal use and service for a period of one year from the date of shipment. This warranty is specifically limited to, at Microscan's sole option, repair or replacement with a functionally equivalent unit and return without charge for service or return freight.

### **What Is Excluded?**

This limited warranty specifically excludes the following: (1) Any products or parts that have been subject to misuse, neglect, accident, unauthorized repair, improper installation, or abnormal conditions or operations; (2) Any products or parts that have been transferred by the original purchaser; (3) Customer mis-adjustment of settings contrary to the procedure described in the Microscan Systems Inc. owners manual; (4) Upgrading software versions at customer request unless required to meet specifications in effect at the time of purchase; (5) Units returned and found to have no failure will be excluded; (6) Claims for damage in transit are to be directed to the freight carrier upon receipt. Any use of the product is at purchaser's own risk. This limited warranty is the only warranty provided by Microscan Systems Inc. regarding the product. Except for the limited warranty above, the product is provided "as is." To the maximum extent permitted by law, this express warranty excludes all other warranties, express or implied, including but not limited to, implied warranties of merchantability and. Technical support questions may be directed to: [helpdesk@microscan.com](mailto:helpdesk@microscan.com) Register your product with Microscan: [www.microscan.com/register](http://www.microscan.com/register) fitness for a particular purpose. Microscan Systems Inc. does not warrant that the functions contained in the product will meet any requirements or needs purchaser may have, or that the product will operate error free, or in an uninterrupted fashion, or that any defects or errors in the product will be corrected, or that the product is compatible with any particular machinery.

### **Limitation of Liability**

In no event shall Microscan Systems Inc. be liable to you or any third party for any special, incidental, or consequential damages (including, without limitation, indirect, special, punitive, or exemplary damages for loss of business, loss of profits, business interruption, or loss of business information), whether in contract, tort, or otherwise, even if Microscan Systems Inc. has been advised of the possibility of such damages. Microscan Systems Inc.'s aggregate liability with respect to its obligations under this warranty or otherwise with respect to the product and documentation or otherwise shall not exceed the amount paid by you for the product and documentation. Some jurisdictions do not allow the exclusion or limitation of incidental or consequential damages or limitations on an implied warranty, so the above limitation or exclusion may not apply to you. This warranty gives you specific legal rights, and you may also have other rights which may vary from state to state.

Tel: 425.226.5700 | Fax: 425.226.8250 | [helpdesk@microscan.com](mailto:helpdesk@microscan.com)

# Table of Contents

Chapter 1	Quick Start	
	Step 1 Check Required Hardware.....	1-2
	Step 2 Connect the System.....	1-3
	Step 3 Position Reader and Symbol .....	1-4
	Step 4 Install ESP .....	1-5
	Step 5 Select Model .....	1-6
	Step 6 Select Communications Protocol .....	1-7
	Step 7 Locate the Symbol in the FOV .....	1-8
	Step 8 Calibrate Settings.....	1-10
	Step 9 Perform Readability Test .....	1-11
	Step 10 Applications.....	1-12
	Step 11 Make Menu Changes and Save in ESP.....	1-13
	Video Output Option.....	1-14
Chapter 2	Using ESP	
	EZ Mode.....	2-2
	Application Mode .....	2-3
	Menu Toolbar .....	2-4
	Connecting .....	2-11
	View.....	2-12
	Navigating in ESP .....	2-13
	Send/Receive Options.....	2-14
Chapter 3	Communications	
	Communications by ESP.....	2-2
	Communications Serial Commands .....	2-3
	RS-232/422 Host Port .....	2-4
	RS-232 Auxiliary Port.....	2-11
	Network .....	2-21
	Preamble .....	2-24
	Postamble .....	2-25
	Response Timeout .....	2-26
	LRC Status .....	2-27
	Aux Port System Data Status.....	2-28
Chapter 4	Read Cycle	
	Read Cycle by ESP .....	3-2
	Read Cycle Serial Commands .....	3-3
	Read Cycle Setup .....	3-4
	Multisymbol .....	3-5
	Trigger .....	3-7
	Serial Trigger.....	3-13
	End of Read Cycle .....	3-15
	Active Camera.....	3-17
	Capture Mode.....	3-18

Capture Timing .....	3-23
Dual Camera Switching .....	3-25
Store Noread Image .....	3-30
<b>Chapter 5      Symbologies</b>	
Symbologies by ESP .....	4-2
Symbologies Serial Commands .....	4-3
Data Matrix .....	4-4
QR Code.....	4-7
Code 39 .....	4-8
Code 128 .....	4-11
BC412.....	4-12
Interleaved 2 of 5.....	4-14
UPC/EAN.....	4-17
Pharmacode .....	4-20
RSS Expanded .....	4-22
RSS Limited.....	4-23
RSS-14 .....	4-24
PDF417 .....	4-25
MicroPDF417.....	4-27
Composite .....	4-28
Narrow Margins .....	4-39
Symbology ID .....	4-30
Background Color.....	4-31
<b>Chapter 6      I/O Parameters</b>	
I/O Parameters by ESP .....	5-2
I/O Parameters Serial Commands.....	5-3
Symbol Data Output .....	5-4
When to Output Symbol Data .....	5-6
Noread Message .....	5-7
Bad/No Symbol Qualification .....	5-10
Read Duration Output.....	5-18
Output Indicators .....	5-19
Serial Verification.....	5-23
Video Output.....	5-25
Image Output.....	5-28
Image Captioning .....	5-30
Synchronous Trigger .....	5-32
EZ Button.....	5-34
Input 1.....	5-38
Output 1 Parameters .....	5-39
Output 2 Parameters .....	5-52
Output 3 Parameters .....	5-54
<b>Chapter 7      Symbol Quality</b>	
Symbol Quality by ESP .....	6-2

---

## Table of Contents

Symbol Quality Serial Commands.....	6-2
Overview of Symbol Quality .....	6-3
Global .....	6-4
Data Matrix .....	6-5
Static Symbol Quality Outputs.....	6-13
<b>Chapter 8 Matchcode</b>	
Matchcode by ESP .....	7-2
Matchcode Serial Commands .....	7-2
Overview of Matchcode .....	7-3
Matchcode Type .....	7-4
Sequential Matching .....	7-5
Match Start Position .....	7-6
Match Length.....	7-7
Wild Card Character .....	7-8
Sequence On Noread.....	7-9
Sequence On Mismatch .....	7-10
Sequence Step .....	7-11
Match Replace .....	7-12
Mismatch Replace .....	7-13
New Master Pin .....	7-14
<b>Chapter 9 Diagnostics</b>	
Diagnostics by ESP .....	8-2
Diagnostics Serial Commands .....	8-2
Counts (Read Only).....	8-3
External Camera Message .....	8-4
Over Temperature Message .....	8-6
Service Message .....	8-7
<b>Chapter 10 Camera Setup</b>	
Camera Setup by ESP .....	9-2
Camera Setup Serial Commands.....	9-2
Video .....	9-3
Evaluation.....	9-5
Region of Interest (ROI) .....	9-8
Dynamic Setup .....	9-12
CCD Image Sensor .....	9-14
CMOS Image Sensor .....	9-15
Illumination Source .....	9-17
Thresholding.....	9-18
Image Processing Settings.....	9-19
Hollow Mode.....	9-21
Mirrored Image .....	9-22
Other Camera Parameters .....	9-23
<b>Chapter 11 IP Database</b>	
IP Database by ESP .....	10-2

IP Database Serial Commands .....	10-3
Overview of IP Database.....	10-4
Operation of IP Database .....	10-4
IP Database Window .....	10-6
Number of Active Database Settings.....	10-7
CCD Image Sensor Database .....	10-8
CMOS Image Sensor .....	10-10
Save Current Settings to Database .....	10-13
Load Current Settings from Database .....	10-13
Request Database Settings.....	10-14
Request All Database Settings.....	10-14
<b>Chapter 12 Terminal</b>	
Terminal Window.....	11-2
Find Function.....	11-3
Macros.....	11-4
Terminal Window Menus.....	11-5
<b>Chapter 13 Utilities</b>	
Utilities Serial Commands .....	12-2
Read Rate .....	12-3
Counters .....	12-4
Device Control .....	12-6
Master Database .....	12-7
Firmware.....	12-12
Bar Code Configuration.....	12-16
Defaulting/Saving/Resetting .....	12-17
Reader Status Requests .....	12-19
Other Operational Serial Commands .....	12-20
<b>Chapter 14 Unique Item Identifiers</b>	
UII Overview .....	13-2
Non-UII Characters in a UII Message Stream .....	13-3
UII Mode Features.....	13-4
Error Messaging .....	13-6
Valid Formats .....	13-8
<b>Chapter 15 Output Format</b>	
Output Format Serial Commands.....	14-2
Output Format Status .....	14-3
Format Assign .....	14-4
Format Extract.....	14-5
Format Insert .....	14-7
Output Filter Configuration .....	14-9
Ordered Output Filter.....	14-13
<b>Chapter 16 Ethernet</b>	
Step 1 Setup.....	15-2

---

*Table of Contents*

Step 2 Preliminary Steps.....	15-3
Step 3 Communicating in Ethernet.....	15-7
Ethernet Application .....	15-8
Appendices	
Appendix A General Specifications .....	A-2
Appendix B Electrical Specifications .....	A-4
Appendix C Quadrus EZ DPM .....	A-8
Appendix D Quadrus EZ FLEX .....	A-9
Appendix E Connectivity Accessories .....	A-10
Appendix F Serial Configuration Commands .....	A-13
Appendix G ASCII Table .....	A-20
Appendix H Data Matrix Symbology.....	A-22
Appendix I Determine Depth of Field .....	A-23
Appendix J Field of View and Lenses .....	A-24
Appendix K Rapid Capture Mode.....	A-28
Appendix L Object Detector .....	A-30
Appendix M Operational Tips .....	A-31
Appendix N Embedded Menus.....	A-32
Appendix O Interface Standards .....	A-33
Appendix P Multidrop Communications .....	A-34
Appendix Q Glossary of Terms .....	A-37



## About the Quadrus EZ Reader

### The key features of the Quadrus EZ are:

- A multi-function EZ button for location, calibration, and reading
- “X” pattern symbol locator
- High speed image processing up to 60 reads per second
- Factory-adjustable focus 2 to 10 inches
- Ability to read both 2D and linear symbols
- Ability to read difficult symbols
- Secondary video input from RS-170 non-interlaced analog cameras

### To aid in setup, the Quadrus EZ incorporates three primary features:

- An “X” locator identifies the center point of the FOV
- A calibration feature to optimize readability
- A green flash (visible from all angles) to signal a successful read

## Host Communications

### There are four ways to configure and test the Quadrus EZ:

1. EZ button.
2. Microscan’s Windows-based **ESP** (Easy Setup Program), which offers point-and-click ease of use and visual responses to user adjustments.
3. Serial commands, such as **<K100,1>**, that can be sent from **ESP’s Terminal** window or another terminal program.
4. The tree control menus and graphic interfaces in **ESP’s App Mode**.

# About the Quadrus EZ Reader User's Manual

This manual provides complete information on setting up, installing, and configuring the reader. The chapters are presented in the order in which a reader might be set up and made ready for operation.

## Highlighting

Serial commands, selections inside instructions, and menu defaults are highlighted in **red bold**. Cross-references are highlighted in **blue**. Web links and outside references are highlighted in **blue bold italics**. References to menu topics are highlighted in **Bold Initial Caps**. References to topic headings within this manual or other documents are enclosed in quotation marks.

## Warning and Caution Summary



- Viewing the Quadrus EZ's LED output with optical instruments such as magnifiers, eye loupes, or microscopes within a distance of 100 mm could cause serious eye injury.
- Maximum LED light output: 648 cd.
- Wavelength: 464 nm; 518 nm; 635 nm.
- Location of the Quadrus EZ's LED aperture window:



*LED Aperture Window*

- **CAUTION:** Use of controls or adjustments or performance of procedures other than those specified herein may result in hazardous radiation exposure.

## **Statement of Agency Compliance**

This equipment has been tested and found to comply with the limits for a Class A digital device, pursuant to part 15 of the FCC Rules. These limits are designed to provide reasonable protection against harmful interference in a residential installation. This equipment generates, uses, and can radiate radio frequency energy, and, if not installed and used in accordance with the instructions, may cause harmful interference to radio communications. However, there is no guarantee that interference will not occur in a particular installation. If this equipment does cause harmful interference to radio or television reception, which can be determined by turning the equipment off and on, the user is encouraged to try to correct the interference by one or more of the following measures:

- Reorient or relocate the receiving antenna
- Increase the separation between the equipment and receiver
- Connect the equipment into an outlet on a circuit different from that to which the receiver is connected
- Consult the dealer or an experienced radio/TV technician for help

For connection to a UL-listed direct plug-in power unit marked Class II and rated 10 to 28 VDC at 10 watts (CCD) or 8 watts (CMOS), or greater if using electrical accessories.

European models must use a similarly rated Class I or Class II power supply that is certified to comply with standard for safety IEC 60950.

### ***Approvals***

This equipment is in compliance or approved by the following organizations:

- CDRH (Center for Devices & Radiological Health)
- FCC (Federal Communications Commission)
- CE (Conformité Européenne)
- BSMI (Bureau of Standards, Metrology and Inspection)

# 1 Quick Start

## Contents

Step 1 Check Required Hardware.....	1-2
Step 2 Connect the System.....	1-3
Step 3 Position Reader and Symbol.....	1-4
Step 4 Install ESP.....	1-5
Step 5 Select Model .....	1-6
Step 6 Select Communications Protocol .....	1-7
Step 7 Locate the Symbol in the FOV .....	1-8
Step 8 Calibrate Settings.....	1-10
Step 9 Perform Readability Test.....	1-11
Step 10 Applications.....	1-12
Step 11 Make Menu Changes and Save in ESP.....	1-13
Video Output Option .....	1-14

This chapter is designed to get your reader up and running quickly using the reader's **EZ** button or **ESP (Easy Setup Program)** so the user can get a sense of its capabilities and test sample symbols.

Detailed setup information for installing the reader into the actual application can be obtained in the subsequent chapters.

In addition to **ESP**, you can send commands to your reader by serial commands and through the reader's embedded menus.

## Step 1 — Check Required Hardware

### To get started with just the EZ Button

You will need:

- A **Quadrus EZ Reader (1)**, FIS 6700-XXXX.
- An **IB-150 Kit**, 98-000040-02, which includes a **cable**, 61-000034-02, and the **IB-150 Interface Box (2)**, 99-000008-02.
- A **Power Supply (3)**, 97-100004-15 (90-264 VAC, 24VDC).

### If connecting to a host by RS-232

You will also need the following:

- A **host computer** with either a terminal communications program or Microscan's **ESP**, which runs under Windows operating system, Windows 98 or higher.
- An **IB-150 Host Communications Cable (6)**, 61-000034-02 (25-pin socket to 9-pin socket).
- **Object Detector (5)** (optional), 99-000017-01.

### If connecting to a host by TCP/IP

See Chapter 15, [Ethernet](#).

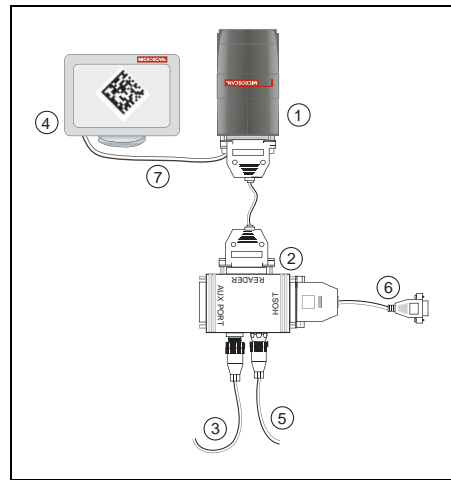

Hardware Configuration

**Caution:** Be sure that all cables are connected **BEFORE** applying power to the system. Always power down **BEFORE** disconnecting any cables.

## Step 2 — Connect the System

You can connect the Quadrus EZ by EZ button, RS-232, or TCP-IP (Ethernet).

### Connecting for EZ Button Setup without a Host

- Connect the **Quadrus EZ Reader** to the **IB-150 Kit**, 98-000040-02.
- Connect **Power Supply**.
- Apply power to the reader.

### Connecting by RS-232

- Connect the reader to the **IB-150 Kit**, 98-000040-02.
- Connect the **IB-150 Host Communications Cable**, 61-000034-02, to the host and the host connector on the side of the **IB-150** interface box.

**Note:** When wiring the interface box to a host with a 25-pin host connector, cross pins 2 and 3. When wiring the interface box to a host with a 9-pin host connector, do NOT cross pins 2 and 3.

1. Connect power supply.
2. Apply power to the reader.

### Connecting to a Host by TCP/IP

See Chapter 15, [Ethernet](#).

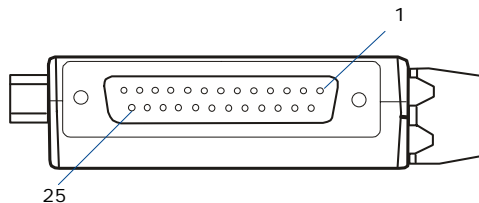

Side View of IB-150 showing Host 25-pin Socket Connection

## Step 3 — Position Reader and Symbol

- Position the reader at the focal distance recommended on the back of the reader, for example **FD = 4"**.
- Tip the reader relative to the symbol to avoid the glare of direct (specular) reflection. The case parting line should be perpendicular to the plane of the symbol by either pitching the symbol or the reader as shown.
- Position the reader in a place devoid of sunlight.
- Symbols can be rotated (tilted) in any angle; however, for best results symbols should be aligned with the FOV (field of view).

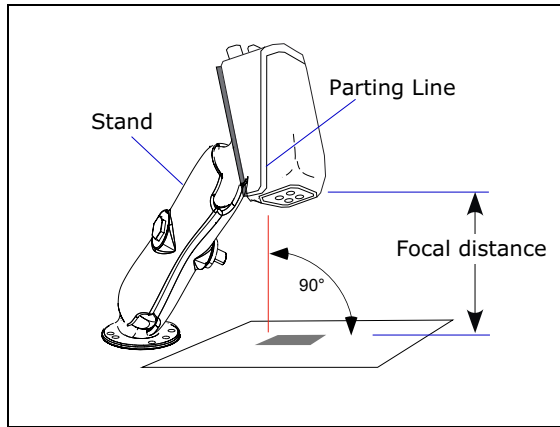

*Reader Position*

- In the case of linear symbols, aligning the bars in the direction of their movement (“ladder” orientation) will minimize the chances of blurring and produce better reads.
- Avoid excessive skew or pitch. Maximum skew is  $\pm 30^\circ$ ; maximum pitch is  $\pm 30^\circ$ .

**Note:** For instant setup and validation, the Quadrus EZ can be hand-held or laid on its side; but for accuracy a mounting stand such as the one shown above is recommended.



## Step 4 — Install ESP

**ESP** stands for **E**asy **S**etup **P**rogram.

**ESP** provides a quick and easy way to set up and configure your reader.

### ***If installing from a Microscan Installation and Support CD:***

1. Insert your Microscan Installation and Support CD in your computer's CD drive.
2. Choose **ESP Software** from the main menu.
3. Launch **Setup.exe** under **ESP** and follow the prompts.

### ***If downloading from the web:***

1. Go to <http://www.microscan.com/downloadcenter>
2. Create a new "myMicroscan" member account or, if you are already a member, enter your user name and password.
3. Click the **Download Software** link and extract the latest version of **ESP** to a directory location of your choice. *Note where your **ESP.exe** file is stored on your hard drive.*
4. At the end of the installation process, the following icon will appear on your desktop:



5. Click the **ESP** icon to start the program.

## Step 5 — Select Model

When you start the program, the following menu will appear:



**Note:** If you need to select another model later, click the **Switch Model** button.

1. Click the Quadrus EZ button and then click **OK**. If you do not want to make this selection every time you start **ESP**, uncheck “Show this window at Startup”.
2. Select the default reader name (**Quadrus EZ-1**), or type a name of your choice in the **Description** text field and click **OK**.
3. Click **Yes** when this dialog appears:

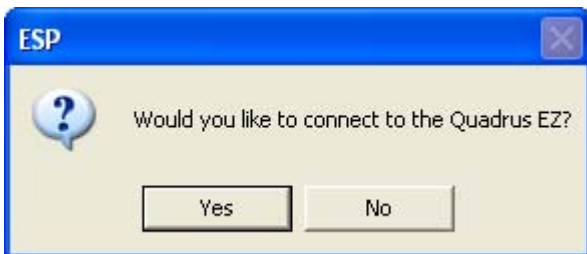

## Step 6 – Select Communications Protocol

When the **Select Protocol** dialog appears, choose either **RS-232** or **TCP/IP** (Ethernet) and click **Next**.

### RS-232

1. In the RS-232 dialog, if your communications port is not the default **COM1**, use the dropdown menu to change your communications port.
2. Click **Connect**.
3. When connected, the **CONNECTED** message will appear in a green box in the status bar on the bottom right of the dialog.

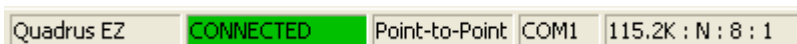

4. If the connection fails, click the **Autoconnect** button, select a different Com port, and try again.

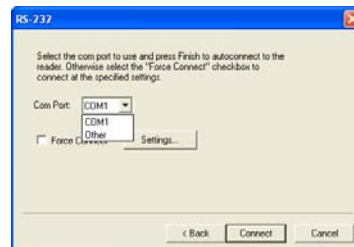

**Note:** If your host settings cannot be changed to match the reader's settings, check the **Force Connect** box.

### TCP/IP (Ethernet)

Both **ESP** and the reader will need to have TCP/IP addresses assigned.

1. If no address has been assigned to the reader, go to Chapter 15, **Ethernet**. If your reader has already been assigned IP addresses, enter the IP address in the dialog box.
2. Click **Connect**.



**Tip:** If you do not see either the **CONNECTED** or **DISCONNECTED** messages at the bottom of your dialog, try expanding the **ESP** window horizontally.

## Step 7 — Locate the Symbol in the FOV

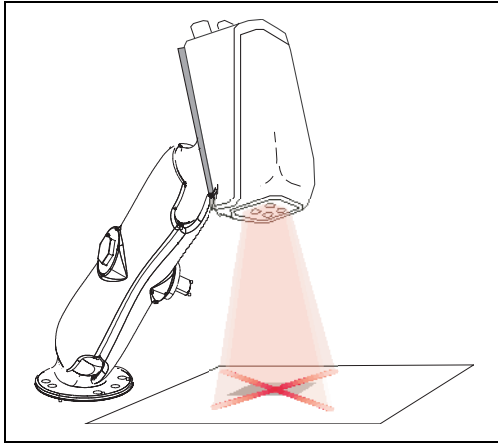

In this step, you move the symbol or the reader so that the “X” pattern is centered over the symbol.

It is important that the whole symbol falls within the field of view (FOV) of the reader. (The FOV is what appears in the Locate/ Calibrate window.)

**Note:** Holding the **EZ** button until you hear **4 beeps** enables **Live** video output (if attached to a monitor).

### Locate by EZ Button

When not connected to a computer, the **EZ** setup button will allow you to quickly locate a symbol in the reader’s FOV.

1. Hold down the **EZ** setup button for about one second and release when you hear one short beep. You will see the blue **X**-pattern.
2. Center the **X**-pattern on the symbol.

**Note:** To end all EZ button functions, press the **EZ** button and quickly release.

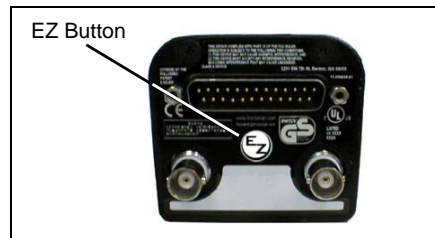

## Locate by ESP

1. In the EZ menu, click the **Locate** button to enable the X-pattern.

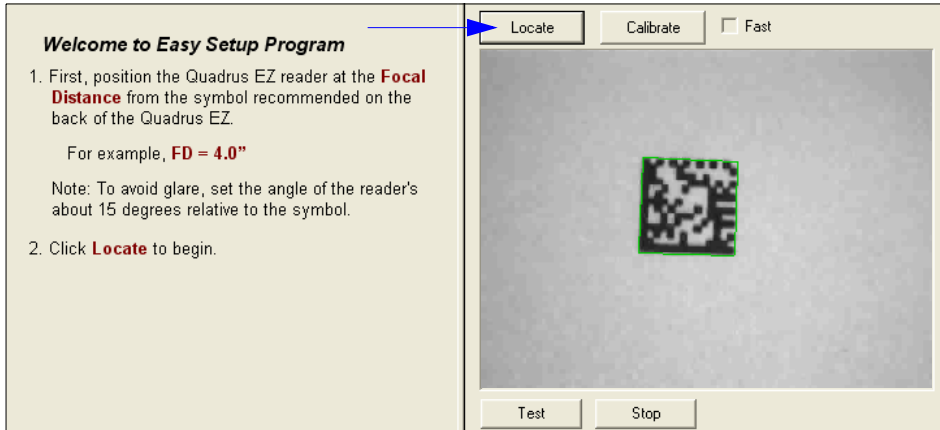

2. You will see the **X**-pattern in front of the reader.
3. Center the **X**-pattern over the symbol you want to read.
4. Click the **Stop** button to end the locate mode.

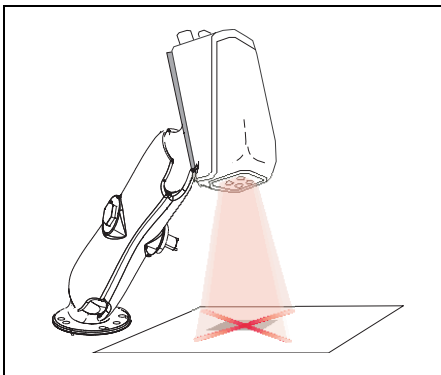

## Step 8 — Calibrate Settings

Quadrus EZ image settings can be adjusted automatically for optimum readability by either the **EZ** setup button or **ESP**.

During the calibration routine, the reader will flash its LEDs while searching through various IP (image processing) settings and matching them with the highest read rates. Upon successful completion of this routine, a green LED pattern will flash brightly and illuminate the symbol. If unsuccessful, the reader will emit 5 short beeps and stop searching.

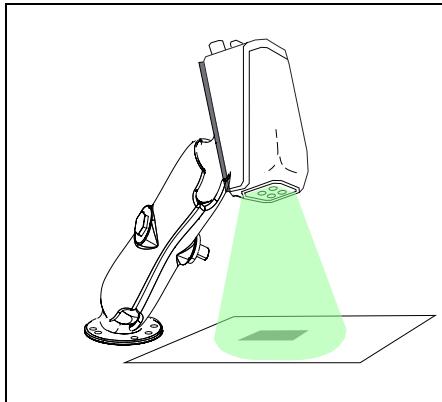

### Calibrate by EZ Button

1. Hold down the **EZ** setup button about 2 seconds and release when you hear **two short beeps**.
2. The reader will search through various IP settings and match them with the highest read rates.

**Note:** To end all EZ button functions, press the EZ button and quickly release.

### Calibrate by ESP

1. Click the **Calibrate** button.
2. The reader will search through various IP settings and match them with the highest read rates.

A rectangular button with the word "Calibrate" written on it in a sans-serif font.

A successful calibration will display a green frame around the symbol. Following this, a message, "Uploading all reader parameters" will appear. After a moment the symbol's data and related features will be presented under the "Symbol Information" box below the image display window.

### Calibrate by Serial Command

Send **<op,6,1>** to begin calibration. Send **<op,6,0>** to end calibration.

## Step 9 — Perform Readability Test

This test will let you know the percent of good reads per captures achieved by the reader.

### Testing by EZ Button

1. To start the read rate test, hold down the **EZ** setup button about 3 seconds until you hear **three short beeps** and see the alternating IP and finder pattern LEDs.

While the symbol is being decoded, the read rate LEDs will indicate the corresponding read rate percentage on the side of the unit.

2. To end the read rate test, press the **EZ** button and quickly release.

### Testing by ESP

1. Click the **Test** button to start the read rate test and **Stop** to end it.

If your symbol has been successfully decoded, its data and related features will be presented under "Symbol Information."

Also, while the symbol is being decoded, the read rate LEDs will indicate the corresponding read rate percentage on the side of the unit as shown above.

2. To end the test, click the **Stop** button.

### Testing by Serial Command

You can also start a test with the **<C>** or **<Cp>** command and end it with the **<J>** command.

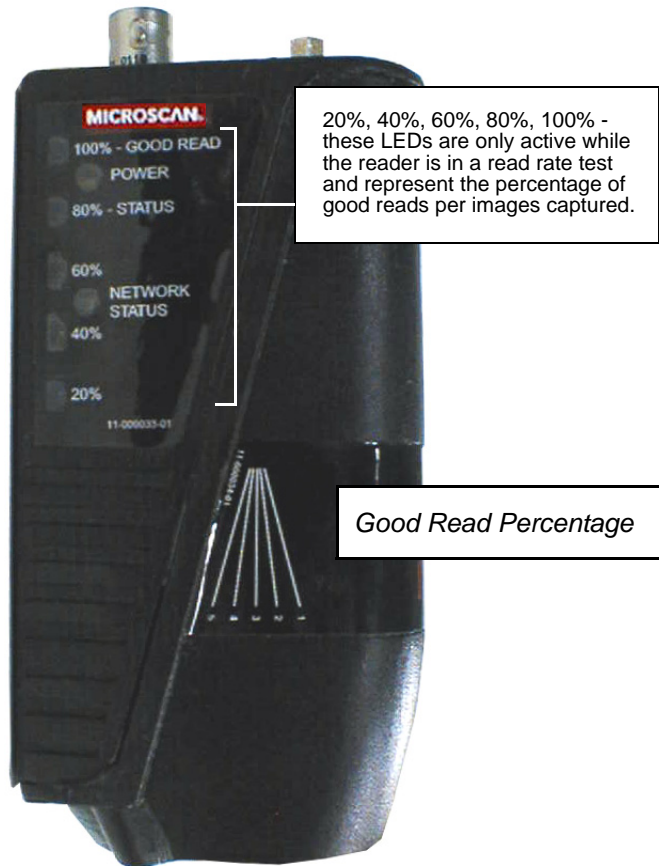

## Step 10 — Applications

To make setup changes to the Quadrus EZ, click the **App Mode** button.

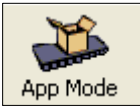

From here you can make changes in the configuration files that appear on the second row of icons.

You can also do the following:

- Send or Receive commands by clicking the **Send/Recv** button.
- Make changes to Camera options by clicking the **Camera** button.
- Access the Terminal window to see data or entering serial commands by clicking the **Terminal** button.
- Review status settings or make changes to operational commands by clicking the **Utilities** button.
- Format data for output by clicking the **Output Format** button.

For details, see **ESP Help** in the pulldown menu.

The window on the left represents the tree control. The window on the right is where image captures are displayed.



## Step 11 — Make Menu Changes and Save in ESP

To make changes to a configuration setting:

1. **Left click** on the + to expand tree.
2. **Double click** on parameter and click once in selection box to view options.
3. Place your cursor in the selection box, scroll down to the setting you want to change and **click** once on the setting.
4. **Left click** again on the open screen to complete the selection.

Parameters	ESP Values
[-] Communications	
[-] Host Port Connections	
Baud Rate	9600
Parity	Even
Stop Bits	One
Data Bits	Seven
Host Protocol	Point-to-Point
[+] Preamble	Disabled
[+] Postamble	Enabled*
	Disabled
	Enabled*

5. **Right click** on the open screen and select **Save to Scanner** to implement the command in the reader.

### You have 3 choices for saving:

- **Send, No Save.** Changes will be lost when power is recycled.

**Caution:** This only saves certain commands to memory.

- All other commands are saved for power-on, the same as the **Send and Save** option.
- **Send and Save.** This activates all changes in current memory *and* saves to the scanner for power-on.
- **Send and Save as Customer Settings.** Same as above, except that these settings are saved to a special section of NOVRAM.

**Note:** This option must be enabled under the Options pull down menu before it will be available as a save option.

## Video Output Option

You can connect a remote video monitor (RS-170/monochrome, non-interlaced) via the video output port on the back of the Quadrus EZ Reader and view live video or triggered events such as a good read, no read, or slide show of on-going captures.

### To Enable Live Video:

Press and hold the **EZ** button until you hear a series of **4 beeps**.



**Note for CCD readers:** When **Live** video mode is active, in order to synchronize with the video format, a shutter time of 1/1000 is the lowest shutter speed setting that can be applied to the camera settings. Slower shutter speeds will disable the video output.

When connected to a remote video with **Live** video mode active, the monitor screen is a close representation of the FOV. This allows you to visually verify that a symbol is within the FOV and the **X**-pattern is centered over it.



**Note:** During normal read cycle operations, the **X**-pattern will not be present unless enabled by **<K750,,1>** or by **ESP**.

### Video Input Option

You can connect an external camera (RS-170/monochrome non-interlaced, progressive format, 512 lines, 30 fps) for streaming captures into the Quadrus EZ Reader.

**Note:** Power to an external camera is not supplied by the Quadrus EZ Reader.

# 2 Communications

## Contents

- Communications by ESP ..... 2-2
- Communications Serial Commands..... 2-3
- RS-232/422 Host Port..... 2-4
- RS-232 Auxiliary Port..... 2-11
- Network..... 2-21
- Preamble..... 2-24
- Postamble..... 2-25
- Response Timeout..... 2-26
- LRC Status..... 2-27
- Aux Port System Data Status ..... 2-28

This section tells how to set up communications parameters with the host and an auxiliary terminal.

With Microscan’s **ESP (Easy Setup Program)**, configuration changes can be made in the **ESP** menus, then sent and saved to your reader. The user can also send serial commands to the reader via the **ESP’s Terminal** window.

**Note:** The characters **NULL <>** and **,** can only be entered through embedded menus, not through **ESP** or serial commands.

# Communications by ESP



Click this button to bring up the **Applications** menu.



Click this button to bring up the **Communications** parameters.

To open nested options, **single-click** the +.

To change a setting, **double-click** the setting and use your cursor to scroll through the options.

Parameters	
[-] Communications	
[-] RS232/422 Host Port	
[-] Host Port Connections	
Baud Rate	115.2K
Parity	None
Stop Bits	One
Data Bits	Eight
Host Protocol	Point-to-Point
Host 422 Status	Disabled
[-] RS232 Auxilliary Port	
[-] Aux Port Connections	
Baud Rate	115.2K
Parity	None
Stop Bits	One
Data Bits	Eight
[-] Aux Port Settings	
[-] Network	
[-] Ethernet	
[-] Preamble	Disabled
[-] Postamble	Enabled
Response Timeout	2
LRC Status	Disabled
[-] Aux Port System Data Status	Disabled*
	Disabled*
	Enabled

## Communications Serial Commands

Host Port Connections	< <b>K100</b> , <i>baud rate, parity, stop bits, data bits</i> >
Host Port Protocol	< <b>K140</b> , <i>protocol</i> >
Host 232/422 Status	< <b>K102</b> , <i>host 422</i> >
Auxiliary Port	< <b>K101</b> , <i>aux port mode, baud rate, parity, stop bits, data bits, daisy chain ID status, daisy chain ID</i> >
Daisy Chain Autoconfigure	< <b>K150</b> <i>DAISY</i> >
Daisy Chain ID	< <b>K151</b> , <i>daisy chain reader #, daisy chain reader ID</i> >
Ethernet Configuration	< <b>K125</b> , <i>IP address, subnet address, gateway address, IP address mode, primary TCP port, video TCP port</i> >
Preamble	< <b>K141</b> , <i>status, preamble characters</i> >
Postamble	< <b>K142</b> , <i>status, postamble characters</i> >
Response Timeout	< <b>K143</b> , <i>response timeout</i> >
LRC	< <b>K145</b> , <i>status</i> >
Aux Port System Data Status	< <b>K146</b> , <i>aux port system data</i> >

# RS-232/422 Host Port

The host port can be configured with RS-232 and RS-422 connections.

## Host Port Connections

These settings define the basic transmission speeds and digital standards that ensure common formatting.

### Baud Rate, Host Port

*Usage:* Can be used to transfer data faster or to match host port settings.

*Definition:* The rate at which the reader and host transfer data back and forth.

*Serial Cmd:* <**K100**, *baud rate*, *parity*, *stop bits*, *data bits*>

*Default:* **115.2K**

*Options:*

0 = 600	1 = 1200	2 = 2400
3 = 4800	4 = 9600	5 = 19.2K
6 = 38.4K	7 = 57.6K	8 = 115.2K

### Parity, Host Port

*Usage:* Only changed if necessary to match host setting.

*Definition:* An error detection routine in which one data bit in each character is set to 1 or 0 so that the total number of 1 bits in the data field is even or odd.

*Serial Cmd:* <**K100**, *baud rate*, **parity**, *stop bits*, *data bits*>

*Default:* **None**

*Options:* 0 = None                      1 = Even                      2 = Odd

### Stop Bits, Host Port

*Usage:* Only changed if necessary to match host setting.

*Definition:* One or two bits added to the end of each character to indicate the end of the character.

*Serial Cmd:* <**K100**, *baud rate*, *parity*, **stop bits**, *data bits*>

*Default:* **One**

*Options:* 0 = One                      1 = Two

## Data Bits, Host Port

*Usage:* Only changed if necessary to match host setting.

*Definition:* One or two bits added to the end of each character to indicate the end of the character.

*Serial Cmd:* <**K100**, baud rate, parity, stop bits, **data bits**>

*Default:* **8**

*Options:* 0 = Seven                      1 = Eight

## Host Port Protocol

- Usage:* In general, the point-to-point protocols will work well in most applications. They require no address and must use RS-232 or RS-422 communications standards.
- Definition:* Protocols define the sequence and format in which information is transferred between the reader and the host, or in the case of **Multidrop**, between readers and a concentrator.
- Serial Cmd:* **<K140,protocol>**
- Default:* **Point-to-Point**
- 0 = Point-to-Point
  - 1 = Point-to-Point with RTS/CTS
  - 2 = Point-to-Point with XON/XOFF
- Options:*
- 3 = Point-to-Point with RTS/CTS & XON/XOFF
  - 4 = Polling Mode D
  - 6 = User Defined

### Point-to-Point (standard)

- Usage:* Used only with RS-232 or RS-422.
- Definition:* Standard **Point-to-Point** requires no address and sends data to the host whenever it is available, without a request or handshake from the host.
- Serial Cmd:* **<K140,0>**

### Point-to-Point with XON/XOFF

- Usage:* If an XOFF has been received from the host, data will not be sent to the host until the host sends an XON. During the XOFF phase, the host is free to carry on other chores and accept data from other devices.  
Used only with RS-232.
- Definition:* This option enables the host to send the XON and XOFF command as a single byte transmission command of start (^Q) or stop (^S).
- Serial Cmd:* **<K140,1>**



## Point-to-Point with RTS/CTS

*Usage:* A reader initiates a data transfer with an RTS (request-to-send) transmission. The host, when ready, responds with a CTS (clear-to-send) and the data is transmitted. CTS and RTS signals are transmitted over two dedicated wires as defined in the RS-232 standard.

Used only with RS-232.

*Definition:* **Point-to-Point with RTS/CTS** (request-to-send/clear-to-send) is a simple hardware handshaking protocol that allows a reader to initiate data transfers to the host.

*Serial Cmd:* <K140,2>

## Point-to-Point with RTS/CTS & XON/XOFF

*Usage:* Used only with RS-232.

*Definition:* This option is a combination of **Point-to-Point with RTS/CTS** and **Point-to-Point with XON/XOFF**.

*Serial Cmd:* <K140,3>

## Polling Mode D

*Usage:* When in **Polling Mode D**, an address of 1 is automatically displayed on the configuration menu. However, during transmission, a 1C hex poll address (FS) and a 1D hex select address (GS) are substituted for the 1.

*Definition:* Like **Point-to-Point**, **Polling Mode D** requires a dedicated connection to the host; but unlike **Point-to-Point**, it requires an address and must wait for a poll from the host before sending data.

*Serial Cmd:* <K140,4>

## User Defined Point-to-Point

*Usage:* Useful for developing custom protocols in polled or unpolled mode.

*Definition:* Allows the user to customize the point-to-point protocol.

*Serial Cmd:* <K140,6,RES,address,REQ,EOT,STX,ETX,ACK,NAK,from host>

### User Defined Address

*Definition:* **User Defined** is considered to be in a polled mode only if an address has been assigned.

*Serial Cmd:* <K140,6 RES,address,REQ,EOT,STX,ETX,ACK,NAK,from host>

*Default:* No address

*Options:* Any ASCII character except a **NULL** <, or >.

## User Defined Example

Example: ACK/NAK protocol can be configured using **User Defined**. The reader will transmit data to the host, when an **ACK** is received, it will carry on with its business. If a **NAK** or response timeout occurs, the reader will re-send the data to the host up to 3 more times before aborting.

*Definition:* **Tip:** To use **User Defined Point-to-Point**, first select **Point-to-Point <K140,0>** and then **User Defined <K140,6>**.

**Example:** To select an unpolled ACK/NAK **User Defined** protocol with LRC disabled, send **<K140,0><K140,6,,,,,,^F,^U><K145,0>**. ACK and NAK will be displayed in the menu.

*Serial Cmd:* **<K140,6,RES,address,REQ,EOT,STX,ETX,ACK,NAK,from host>**

*Default:* **No assignment**

*Options:* Any ASCII character except a null. Control characters can be used to define RES through NAK in serial commands.

## From Host

This option allows the handshaking protocol to be initiated from the host, if not configured in an unpolled mode. Messages sent to the host will include the reader's defined protocol. The status of **From Host** determines if messages sent from the host to the reader must include the defined protocol. If **From Host** is disabled, the defined protocol is not included. If **From Host** is enabled, the defined protocol must be included.

*Definition:*

*Serial Cmd:* **<K140,6,RES,address,REQ,EOT,STX,ETX,ACK,NAK,from host>**

*Default:* **Disabled**

*Options:* 0 = Disabled      1 = Enabled

## Multidrop

- Usage:* A concentrator can be used to connect up to 50 devices to a single host port connection.
- Definition:* **Multidrop** allows up to 50 devices to be connected to a single RS-485 host, with the reader assigned an unique address (from 01 to 50).
- Multidrop Addresses:* Each address has its own separate poll and select address (from 1C to 7F hex).
- Options:* 01 through 50
- Serial Cmd:* If selecting **Multidrop** (K140,5) an address must be defined and appended to the command string.  
Format: <**K140,5,address**>

When **Multidrop** is selected, the protocol characters for RES, REQ, etc. are assigned automatically.

## User Defined Multidrop

- Usage:* This option is used when connecting to a concentrator or other device that does not match standard multidrop protocol.  
If selecting **User Defined Multidrop** (7), complete the format by either choosing new parameters or place commas where unchanged data fields occur.
- Definition:* **User Defined Multidrop** allows the user to customize the polling protocol.  
<**K140,7,RES,address,REQ,EOT,STX,ETX,ACK,NAK**>
- Serial Cmd:* For **User Defined Multidrop**, first select **Multidrop <K140,5>**, then **User Defined Multidrop <K140,7...>**.
- Address:* Any single character (02 hex to 7E hex) in the ASCII table can be assigned as the address character. The character chosen is used as the poll character and the subsequent ASCII character becomes the select character. For example, if a **^B** (02 hex) is selected as the address, **^C** (03 hex) becomes the select address that the host will use in sending host select commands.

**Note:** Any ASCII character except a null (00) and a **^A** (01) can be assigned as an address. Control characters can be used to define RES through NAK in serial commands.

**Note:** Definitions of commands in **User Defined** and **User Defined Multidrop** must be duplicated in host applications to enable poll and select sequences to execute correctly during transmission.

**Note:** Typically, parameters in **User Defined Multidrop** are defined by first enabling **Multidrop**, then enabling **User Defined Multidrop**. This pre-loads multidrop characters into the parameters. Then changes are made to individual characters to match the host or other requirements.

## **Host 422 Status**

*Usage:* RS-232 is an industry standard. RS-422 is used where greater cable lengths are required and/or where noise interference is an issue.

Host 422 if enabled allows communication through the 422 I/O lines.

*Definition:* When Host 422 is enabled, RS-232 is disabled.

When Host 422 is disabled, RS-232 is enabled.

*Serial Cmd:* **<K102,host 422>**

*Default:* **Disabled**

*Options:* 0 = Disabled      1 = Enabled

## RS-232 Auxiliary Port

The auxiliary port offers an alternative port that can be configured to communication in RS-232 in several modes including daisy chain.

### Aux Port Connections

As with the host port parameters, the auxiliary port settings (baud rate, parity, stop bits, and data bits) must be identical with those of the auxiliary device.

**Note:** Aux port connections are not available when Ethernet is enabled.

*Usage:* An auxiliary port connects the reader to a remote display or to other readers that can display or transfer data.

*Definition:* These commands set the communication parameters with the auxiliary port which can be used to configure menus, send data to the host, display data transmissions originating from the host of the reader, and relay data from other readers set in tandem (daisy chained).

### Baud Rate, Aux Port

*Usage:* Can be used to transfer data faster or match an auxiliary device.

*Definition:* The rate at which the reader and host transfer data back and forth.

*Serial Cmd:* <**K101**,aux port mode,**baud rate**,parity,stop bits,data bits,daisy chain ID status,daisy chain ID>

*Default:* **115.2K**

	0 = 600	1 = 1200	2 = 2400
<i>Options:</i>	3 = 4800	4 = 9600	5 = 19.2K
	6 = 38.4K	7 = 57.6K	8 = 115.2K

### Parity, Aux Port

*Usage:* Only changed if necessary to match host setting.

*Definition:* An error detection routine in which one data bit in each character is set to 1 or 0 so that the total number of 1 bits in the data field is even or odd.

*Serial Cmd:* <**K101**,aux port mode,baud rate,**parity**,stop bits,data bits,daisy chain ID status,daisy chain ID>

*Default:* **None**

<i>Options:</i>	0 = None	1 = Even	2 = Odd
-----------------	----------	----------	---------

## Stop Bits, Aux Port

*Usage:* Only changed if necessary to match host setting.

*Definition:* Allows the user to select the last one or two bits in each character to indicate the end of the character.

*Serial Cmd:* <**K101**,aux port mode,baud rate,parity,**stop bits**,data bits,daisy chain ID status,daisy chain ID>

*Default:* **One**

*Options:* 0 = One                      1 = Two

## Data Bits, Aux Port

*Usage:* Only changed if necessary to match host setting.

*Definition:* Number of bits in each character.

*Serial Cmd:* <**K101**,aux port mode,baud rate,parity,stop bits,**data bits**,daisy chain ID status,daisy chain ID>

*Default:* **Eight**

*Options:* 0 = Seven                      1 = Eight

## Auxiliary Port Mode

*Definition:* Determines the flow of data between the auxiliary port device(s), the reader, and the host.

*Serial Cmd:* <**K101**,aux port mode,baud rate,parity,stop bits,data bits,daisy chain ID status,daisy chain ID>

*Default:* **Disabled**

*Options:* 0 = Disabled              1 = Transparent              2 = Half duplex  
3 = Full duplex              4 = Daisy chain              5 = Command Processing

**Note:** RS-232 host and aux port are available with full functionality.

## Transparent Mode

### Usage:

A common application, in conjunction with handheld readers, is one that employs an auxiliary readout to detect mis-applied symbols.

In **Transparent** mode data is passed between the auxiliary port and the host. The reader buffers data from the auxiliary port and echoes the keyed data on the auxiliary port.

- Auxiliary port data is passed through to the host whenever a return key is pressed at the auxiliary port or whenever symbol data is sent. If sent with symbol data, it is processed on a first-in/first-out basis.
- Auxiliary port data to the host is always sent with a preamble and a postamble.
- If the reader is in a polled mode to the host, auxiliary port data will still pass through.
- **<D>** is the only command accepted by the reader from the auxiliary port. All other commands will pass through to the host.

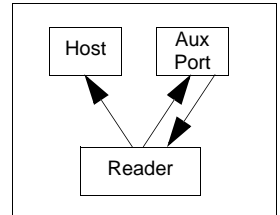

### Definition:

#### Data initiated from the Reader

- Transmission to the auxiliary port occurs immediately upon a good read.
- Data sent to the auxiliary port does not include a preamble or a postamble.
- Communications with the auxiliary port is always in Point-to-Point protocol, even if the host is in a polled protocol mode.

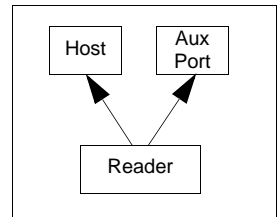

#### Data initiated from the Host

- All host data is echoed to the auxiliary port in unpolled mode.

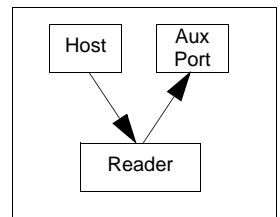

### Serial Cmd:

**<K101,aux port mode,baud rate,parity,stop bits,data bits,daisy chain ID status,daisy chain ID>**

**1 = Transparent**

## Half Duplex Mode

*Usage:* Useful when the user wants symbol data displayed on an auxiliary menu close to the reader.

In **Half Duplex** mode all auxiliary port data and symbol data is sent directly to the host. Symbol data is displayed on the auxiliary port menu at the same time the data is sent to the host.

### Data initiated from the Auxiliary Port

- Auxiliary port data to the host is ignored if the reader is in a polled mode.
- Auxiliary port data or read data is sent to the host whenever it is received.
- Auxiliary port data is not echoed.
- Auxiliary port data to the host is always sent without a preamble or a postamble.
- <D> is the only command that is accepted by the reader from the auxiliary port. All other commands are passed through to the host.

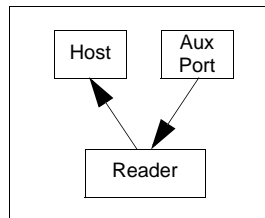

*Definition:*

### Data initiated from the Reader

- Data is transmitted to the auxiliary port at the same time it is transmitted to the host.
- Data transmission conforms with all parameters specified in the configuration menu (e.g., **Preamble**, **Postamble**, **End of Read Cycle**).

### Data is initiated from the Host

- All host data is echoed to the auxiliary port in unpolled mode.

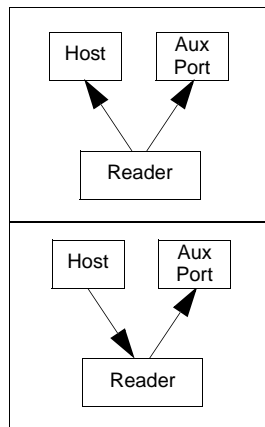

*Serial Cmd:* **<K101,aux port mode,baud rate,parity,stop bits,data bits>**  
**2 = Half Duplex**



## Full Duplex Mode

*Usage:* When communication to and from the auxiliary port is required.

In **Full Duplex** mode all auxiliary port data and symbol data is sent directly to the host. Symbol data is not displayed on the auxiliary port menu.

### Data initiated from the Auxiliary Port

- Auxiliary port data to the host is ignored if the reader is in a polled mode.
- Auxiliary port data or read data is sent to the host whenever it is received.
- Auxiliary port data is not echoed.
- Auxiliary port data to the host is always sent without a preamble or a postamble.
- <D> is the only command that is accepted by the reader from the auxiliary port. All other commands are passed through to the host.

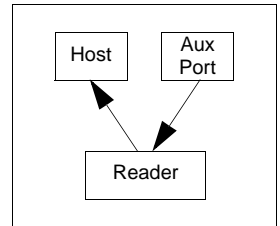

### Data initiated from the Reader

*Definition:*

- Data is not sent to the auxiliary port.

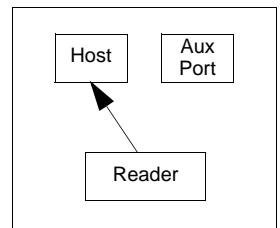

### Data initiated from the Host

- All host data is echoed to the auxiliary port in unpolled mode.

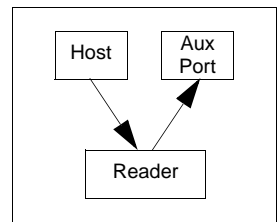

*Serial Cmd:* <**K101,aux port mode**,baud rate,parity,stop bits,data bits,daisy chain ID status,daisy chain ID>

**3 = Full duplex**

## Daisy Chain Mode

Useful in applications where:

*Usage:*

- More than one symbol type is present.
- A symbol may be present on multiple sides of a package.
- Symbols are presented at different depths.

In a daisy chain application, readers are connected in tandem or “daisy chain” and decoded data is relayed from one reader to another on up to the host.

*Definition:*

A master reader has its host port linked to the host computer and its auxiliary port linked to the host port of the first secondary reader in the chain. Thereafter, each secondary reader’s auxiliary port is linked to the host port of the secondary reader that is further from the host in the daisy chain. Each reader in the daisy chain can be assigned an ID that accompanies any data that it sends.

*Serial Cmd:*

**<K101,aux port mode,baud rate,parity,stop bits,data bits,daisy chain ID status,daisy chain ID>**

*Options:*

**4 = Daisy chain**

Before the master reader times out, it checks its auxiliary port for data. It should be set to wait at least **30** mS for each secondary reader in the daisy chain. If no data is received within the read cycle timeout, the master sends a noread message to the host. Otherwise the complete data is sent.

If for example the master reader is set to timeout in 120 mS, the first secondary reader downstream might be set to 90 mS, the next to 30 mS, and so forth, thus assuring that at least 30 ms elapses between transmissions.<sup>a</sup>

*Function:*

Daisy-chained readers can send a series of symbols by enabling **Multisymbol** and a common multisymbol separator. If the master reader does not receive the expected number of symbols, noread messages are appended to the data string to make up the difference between the number of symbols enabled in **Multisymbol** and the number of symbols read.

For example, a master and two secondary readers have **Number of Symbols** set to 3 and **Multisymbol Separator** defined as %. If the master and the first secondary reader do not find symbols, but the next secondary reader registers a good read, the transmitted results would be: symbol data % noread % noread.

a. The above example is based on the best case. Other factors such as baud rate, dynamic focus timing, number of characters in a given symbol, and the number of secondary readers in the daisy chain can affect timing and may need to be included in your calculations for complete accuracy.

## Command Processing Mode

- Usage:* Allows user to send configuration from the Host port or the AUX port. When enabled, **Command Processing** allows commands to be entered via the aux port and direct externally triggered read cycle data in one of two ways:
- Definition:*
1. Bar code data, including the serial trigger if used, will be transmitted to the last port from which a command was sent.
  2. If the last command came from the host port, then externally triggered read cycle data will only be output to the host port.
- Serial Cmd:* <**K101,aux port mode**,baud rate,parity,stop bits,data bits,daisy chain ID status,daisy chain ID>
- Options:* **5 = Command Processing**

## Daisy Chain ID Status

*Usage:* Used in a daisy chain setup in cases where the host needs to know which reader in a daisy chain setup sent the data.

*Definition:* Each reader in a daisy chain can be assigned a one or two character ID that will appear in front of decoded data and identify its source.

*Serial Cmd:* <**K101**,aux port mode,baud rate,parity,stop bits,data bits,**daisy chain ID status**,daisy chain ID>

*Default:* **Disabled**

*Options:* 0 = Disabled 1 = Enabled

**Note:** Enable/disable and length must be the same in all readers.

## Daisy Chain ID

*Usage:* Used in a daisy chain setup in cases where the host needs to know which reader sent the data.

*Definition:* A one or two character prefix which identifies the particular daisy chain reader from which the data is being sent.

*Serial Cmd:* <**K101**,aux port mode,baud rate,parity,stop bits,data bits,daisy chain ID status,**daisy chain ID**>

*Default:* **1/**

*Options:* Any one or two ASCII characters.

## Daisy Chain Autoconfigure

**Usage:** For quick setup and configuration of the daisy chain network.

**Daisy Chain Autoconfigure** is issued to the master reader in the daisy chain and the software responds as follows:

- Counts the number of secondary readers in the daisy chain.
- Assigns an internal ID number (1...n) to each secondary reader, where the first secondary reader is number 1 (and its own ID being a 0).
- Propagates the communications settings and the relevant operating modes of the master reader to the host and auxiliary ports of each secondary reader.
- Resets each secondary reader.
- Verifies that each secondary reader has acquired the new settings.

**Definition:**

**Serial Cmd:** <**K150DAISY**>

**Note:** All secondary readers must be set to **Serial** for **Daisy Chain** to function.

When setting up a daisy chain operation, do the following:

1. Set the master (the reader connected to the host) reader to **Serial**.

This sets all the readers in the daisy chain to **Serial** when the command is carried out.

Before **Autoconfigure** you must set the master reader to **Serial (S)**:



2. Send <**K150DAISY**> command.
3. If necessary, set the master reader to **Edge**.

After **Autoconfigure** you may set the master reader to **Edge (E)** but the other readers must remain in **Serial (S)**:



## **Daisy Chain Remote Secondary Reader ID**

**Note:** Not in **ESP**.

**Usage:** This command provides a handy way to assign custom daisy chain IDs to specific readers that were assigned during the daisy chain autoconfigure process.

**Definition:** Assigns a new daisy chain ID to a daisy chain secondary reader. The command is sent to the master reader to configure the other secondary readers.

### **Daisy Chain Reader Number**

**Definition:** Specifies the target reader (by sequential number) which will be receiving the new Daisy Chain ID. The master reader is always 0 (zero). All secondary readers are numbered 1...n in the order that they are connected.

**Note:** These numbers are for assigning IDs only and are not changeable.

**Serial Cmd:** **<K151,daisy chain reader #,daisy chain reader ID>**

**Options:** 1...n (0 for the master reader)

### **Daisy Chain Reader ID**

**Definition:** A two-character user-defined ASCII message identifying a reader in the daisy chain.

**Serial Cmd:** **<K151,daisy chain reader #,daisy chain reader ID>**

**Default:** Sequential numbering of reader units resulting from the Daisy Chain Autoconfigure **<K150>** command; for example: ID Master = **1/**; ID Reader 1 = **2/**; ID Reader 2 = **3/**; etc.

**Options:** Any two characters except **NULL < , or >**.

**Note:** After a secondary reader accepts a new ID, it automatically invokes a reset-with-save command.

# Network

These port options are mutually exclusive and predetermined according to the FIS type associated with the unit. For example, if you have an **Ethernet** enabled unit, you will not be able to use **USB** or **RS-485 Multidrop** commands.

Network connections are made through the IB-151 connector, but setup is done through RS-232 connections.

## Ethernet

See Chapter 15, [Ethernet](#), for more on Ethernet connections.

## IP Address

*Definition:* The 32-bit address defined by the Internet Protocol in RFC 791 (version 4). The Internet Protocol is the network layer for the TCP/IP Protocol Suite. It is a connectionless, best-effort packet switching protocol.

*Usage:* Use this to configure the reader with an IP address compatible with the host network. Note that this only takes effect when **IP Address** mode is configured for **Static** mode.

*Serial Cmd:* **<K125, IP address, subnet address, gateway address, IP address mode, primary TCP port, video TCP port>**

*Default:* **192.168.0.100**

*Options:* 0.0.0.0 to 255.255.255.255

## Subnet

*Definition:* The subnet portion of an IP address. In a subnetted network, the IP address is split into a subnet portion and a host portion using an address (subnet) mask. A bit mask is used to identify which bits in an IP address correspond to the network and subnet portions of the address.

*Usage:* Use this to configure a subnet mask that is compatible with the host network and the reader's IP address.

*Serial Cmd:* **<K125, IP address, subnet address, gateway address, IP address mode, primary TCP port, video TCP port>**

*Default:* **255.255.255.0**

*Options:* 0.0.0.0 to 255.255.255.255

## Gateway Address

*Definition:* AA gateway is a communications device/program which passes data between networks having similar functions but dissimilar implementations. This should not be confused with a protocol converter.

*Usage:* This parameter is currently unused by the reader.

*Serial Cmd:* <**K125**, IP address, subnet address, **gateway address**, IP address mode, primary TCP port, video TCP port>

*Default:* **0.0.0.0**

*Options:* 0.0.0.0 to 255.255.255.255

## IP Address Mode

*Definition:* Configures the method the reader will use to acquire its IP address.

*Usage:* If host network has a DHCP server, then DHCP mode can be used to assign the reader an IP address from a central location. Typically, the DHCP server can be configured with the reader's MACID so a known IP can be assigned. If the host network does not have a DHCP server, then the reader must be programmed with a "Static" IP address.

*Serial Cmd:* <**K125**, IP address, subnet address, gateway address, **IP address mode**, primary TCP port, video TCP port>

*Default:* **Static**

*Options:* 0 = Static. (The reader uses IP address configured via K command, **ESP**, or embedded menu.)

1 = DHCP (The reader acquires an IP address from a DHCP/BOOTP)

## Primary TCP Port

*Definition:* TCP port in which the reader receives commands and sends bar code data.

*Usage:* The port number is configured for the convenience/preference of the host system.

**Note:** The primary TCP port and the video TCP must be different.

*Serial Cmd:* <**K125**, IP address, subnet address, gateway address, IP address mode, **primary TCP port**, video TCP port>

*Default:* **2001**

*Options:* 1024 to 65535



## Video TCP Port

*Definition:* TCP port in which the reader sends responses to **ESP**-related commands (video, symbol information, histogram) from the Primary TCP port. Note that if the Video TCP port is unconnected, the reader will respond to the Primary TCP port instead.

**Note:** The primary TCP port and the video TCP must be different.

*Usage:* The port number is configured for the convenience/preference of the host system.

*Serial Cmd:* <**K125**, IP address, subnet address, gateway address, IP address mode, primary TCP port, **video TCP port**>

*Default:* **2002**

*Options:* 1024 to 65535

# Preamble

## Preamble Status

*Usage:* Useful for identifying and controlling incoming data. For example, defining the preamble as a carriage return and a line feed causes each decoded message to be displayed of on its own line.

*Definition:* Define a one to four character data string that can be added to the front of the decoded data.

*Serial Cmd:* <**K141**,*status*,*preamble character(s)*>

*Default:* **Disabled**

*Options:* 0 = Disabled      1 = Enabled (within any protocol)

## Preamble Character(s)

*Serial Cmd:* <**K141**,*status*,*preamble character(s)*>

*Default:* **^M** corresponding to: **carriage return/null/null/null**.

### **Within a Serial Command**

To enter control characters within a serial command, hold down the control key while typing the desired character.

Example: <**K141**,**1**,**CNTL-m**> to enter **^M**.

### **Within an Embedded Menu**

*Options:* Control characters entered on the command line are displayed in the menu as mnemonic characters, such as: <**CR**><**NUL**><**NUL**><**NUL**>.

To enter a control character from within an embedded menu, first type in a space (with the space key). This has the effect of allowing the control key to be recognized as a part of the control character. Next hold down the control key while typing the desired character.

Example: **Space CNTL-m** to enter **^M**.

# Postamble

## Postamble Status

- Usage:** Useful for identifying and controlling incoming data. For example, defining the postamble as a carriage return and a line feed causes each decoded message to be displayed on its own line.
- Definition:** Allows the user to enable or disable up to four postamble character(s) that can be added to the end of the decoded data.
- Serial Cmd:** **<K142,status,postamble character(s)>**
- Default:** **Enabled**
- Options:** 0 = Disabled                      1 = Enabled (within any protocol)

## Postamble Character(s)

- Serial Cmd:** **<K142,status,postamble character(s)>**
- Default:** **^M^J**. Corresponds to carriage return/line feed/null/null, as displayed in the menu.
- Up to four user-defined ASCII character, including control characters.

### **Within a Serial Command**

To enter control characters within a serial command, hold down the control key while typing the desired character.

Example: **<K142,1,CNTL-m CNTL-j>** to enter **^M^J**.

### **Options:** **Within an Embedded Menu**

Control characters entered on the command line are displayed in the menu as mnemonic characters, such as: **<CR><LF><NUL><NUL>**

To enter a control character from within an embedded menu, first type in a space (with the space key). This has the effect of allowing the control key to be recognized as a part of the control character. Next hold down the control key while typing the desired character.

Example: **Space CNTL-m Space CNTL-j** to enter **^M^J**.

## Response Timeout

- Usage:* Only used when a response is required from the host. While in **Multidrop**, if the reader does not receive an **ACK** or **NAK** from the host after sending polled data, it will act on a fault. The reader can be set to wait indefinitely by setting **Response Timeout** to zero.
- Definition:* Time the reader will wait before timing out if **ACK**, **NAK**, and **ETX** are enabled, and a host response is expected.
- Serial Cmd:* **<K143, response timeout>**
- Default:* **2** (in 10mS increments = **20**mS)
- Options:* 0 to 255 (A zero (0) setting causes an indefinite wait.)

---

# LRC Status

## *(Longitudinal Redundancy Check)*

*Usage:* Used when extra data integrity is required.

*Definition:* An error-checking routine that verifies the accuracy of transmissions. It is the exclusive OR of all characters following the **STX** (start of text) up to and including the **ETX** (end of text). What this means is that the binary representation of all the characters in a transmissions are cumulatively added in a column and each resulting odd integer is assigned a 1 and each even integer a **0** (two 1s = 0, two 0s = 0, a 1 and a 0 = 1). The extra **LRC** character is then appended to the transmission and the receiver (usually the host) performs the same addition and compares the results.

*Serial Cmd:* <**K145,status**>

*Default:* **Disabled**

*Options:* 0 = Disabled          1 = Enabled

## **Aux Port System Data Status**

*Definition:* When enabled, directs data from the reader to the auxiliary port.

*Serial Cmd:* **<K146,aux port system data>**

*Default:* **Disabled**

*Options:* 0 = Disabled      1 = Enabled

# 3 Read Cycle

## Contents

Read Cycle by ESP .....	3-2
Read Cycle Serial Commands .....	3-3
Read Cycle Setup.....	3-4
Multisymbol.....	3-5
Trigger .....	3-7
Serial Trigger .....	3-13
End of Read Cycle.....	3-15
Active Camera .....	3-17
Capture Mode.....	3-18
Capture Timing.....	3-23
Dual Camera Switching.....	3-25
Store Noread Image .....	3-30

After you've established communications and completed basic read rate testing, you will need to address the spatial and timing parameters associated with your application.

**Note:** The characters **NULL <>** and **,** can only be entered through embedded menus, not through **ESP** or serial commands.

# Read Cycle by ESP

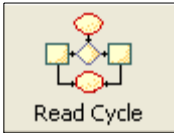

Click this button to bring up the **Read Cycle** menu.

To open nested options, **single-click** the +.

To change a setting, **double-click** the setting and use your cursor to scroll through the options.

Parameters	
[-] Read Cycle	
[+] Multisymbol	
[-] Trigger	
Mode	External Edge
Trigger Filter Duration	313
External Trigger State	Active Closed
[+] Serial Trigger	
[-] End of Read Cycle	
Mode	Timeout
Read Cycle Timeout	100
Active Camera	Internal Camera
[-] Capture Mode	Rapid Capture
Number of Captures	1
Rapid Capture Mode	Timed Capture
[+] Capture Time	
[+] Dual Camera Switching	
[-] Store Noread Image	
Image Storage Type	Disabled
Image Storage Mode	First Image*
	First Image*
	Last Image



## Read Cycle Serial Commands

Multisymbol	< <b>K222</b> , <i>number of symbols,multisymbol separator</i> >
Trigger Mode/Duration	< <b>K200</b> , <i>trigger mode,trigger filter duration</i> >
External Trigger State	< <b>K202</b> , <i>external trigger state</i> >
Serial Trigger Character	< <b>K201</b> , <i>serial trigger character</i> >
Start Trigger Character	< <b>K229</b> , <i>start character</i> >
Stop Trigger Character	< <b>K230</b> , <i>stop character</i> >
End of Read Cycle	< <b>K220</b> , <i>end of read cycle,read cycle timeout</i> >
Active Camera	< <b>K240</b> , <i>active camera</i> >
Captures	< <b>K241</b> , <i>capture mode,number of captures,rapid capture mode</i> >
Capture Timing	< <b>K242</b> , <i>time before 1st capture,time between capture 1 and 2 ,,,,,,,time between capture 7 and 8</i> >
Dual Camera Operations	< <b>K243</b> , <i>switching mode,number of internal camera captures, number of external camera captures,internal camera timeout, external camera timeout</i> >
Store Noread Image	< <b>K244</b> , <i>image storage type,image storage mode</i> >

## Read Cycle Setup

Based on your application, setting up read cycle and triggering parameters will involve a series of decisions, as follows:

1. Select the number of symbols to be read in a read cycle (must not exceed **Number Of Captures**).
2. Decide the trigger type to be used: if serial, the serial character; if external, **Level** or **Edge**.
3. Designate how the read cycle should end (**Timeout, New Trigger, Last Frame**)
4. Calculate the maximum and minimum field of view (FOV).
5. Consider the speed of the transport in inches per second
6. Select **Capture** mode, **Continuous** or **Rapid**.
7. Select **Number Of Captures**.
8. Set the **Time Before First Capture** and **Time Between Captures**, if any.
9. If using an external camera, select the active camera(s).
10. Decide if you need to alternate between cameras, with **Switching Mode**.
11. Save settings to the IP database.

**Note:** With a CCD sensor, images can be captured at a rate of 60/second. In CMOS, capture rate is 30/second.

# Multisymbol

- Usage:** **Multisymbol** is commonly used in shipping applications where a shipping symbol contains individual symbols for part number, quantity, etc. This feature allows one trigger to pick up all the symbols.
- Definition:** **Multisymbol** allows the user to define up to 6 symbols that can be read in a single read cycle.
- The following conditions apply:
1. Each symbol must be different to be read.
  2. The maximum number of characters in a read cycle is 32,520 for all symbols.
  3. The maximum number of characters the reader can transmit is calculated by: Preamble + maximum number of symbols \* (aux id + symbology id + maximum symbol length + ((number of insertion cells x cell length) + separator) + postamble + LRC = 37,425.
  4. All noread messages are posted at the end of the data string.
  5. If more than one symbol is within the field of view at the same time, symbol data may not be displayed in the order of appearance.
  6. If **Matchcode Type** is set to **Sequential** or if **Trigger** is set to **Continuous Read 1 Output, Number of Symbols** will default to **1** (if set to any number greater than 1).
- Conditions:**

## Number of Symbols

- Definition:** **Number of Symbols** is the number of different symbols that can be read in a single read cycle.
- Serial Cmd:** <**K222, number of symbols, multisymbol separator**>
- Default:** **1**
- Options:** 1 to 6

## **Multisymbol Separator**

*Usage:* Used to delimit or separate data fields with a user defined character.

*Definition:* Any valid ASCII character, inserted between each symbol read when **Multisymbol** is set to any number greater than 1.

*<K222, number of symbols, multisymbol separator>*

*Serial Cmd:* **Note:** If **Multisymbol Separator** has been changed to any other character than the default comma and you wish to re-define the separator as a comma, use **ESP** or the embedded menus.

*Default:* , (comma)

*Options:* Any available ASCII character, except < or > (if used as delimiters).

**Note:** If a **NULL** is entered for the multisymbol separator, the multisymbol separator output will be disabled.

**Note:** If noread messages are disabled and there are noreads occurring, separators will only be inserted between symbol data outputs.

# Trigger

**Note:** When doing calibration or read rate testing, the current trigger setting will be disregarded.

*Definition:* The type of trigger event that will initiate the read cycle.

## Trigger Mode

*Serial Cmd:* <**K200**, *trigger mode*, trigger filter duration>

*Default:* **External Edge**

0 = Continuous Read

1 = Continuous Read 1 Output

*Options:* 2 = External Level

3 = External Edge

4 = Serial Data

5 = Serial Data & External Edge

## Continuous Read

*Usage:* **Continuous Read** is useful in testing symbol readability or reader functions. It is not recommended for normal operations.

In **Continuous Read**, trigger input options are disabled, the reader is always in the read cycle, and it will attempt to decode and transmit every capture.

*Definition:*

**When To Output** and **Noread** options have no affect on **Continuous Read**.

*Serial Cmd:* <**K200**, 0>

## Continuous Read 1 Output

*Usage:* **Continuous Read 1 Output** can be useful in applications where it is not feasible to use a trigger and all symbols contain different information. It is also effective in applications where the objects are presented by hand.

*Definition:* In **Continuous Read 1 Output** the reader self-triggers whenever it decodes a new symbol or a timeout occurs.

If **End Of Read Cycle** is set to **Timeout** and the symbol doesn't change, the output is repeated at the end of each timeout period. For example, if **Timeout** is set to one second, the reader sends the symbol data immediately and repeats the output at intervals of one second for as long as the symbol continues to be captured.

If **End Of Read Cycle** is set to **New Trigger**, the reader will send the current symbol data immediately, but send it only once. A new symbol appearing in the reader's range will be read and sent immediately provided it is not identical to the previous symbol read.

*Serial Cmd:* <**K200,1**>

**Caution:** In automated environments, **Continuous Read 1 Output** is not recommended because there is no one to verify that a symbol was missed.

**Note:** If **Trigger Mode** is set to **Continuous Read 1 Output**, **Number of Symbols** will default to **1** (if set to any number greater than 1).

## External Trigger Level

**Usage:** This mode is effective in an application where the speeds of the conveying apparatus are variable and the time the reader spends reading each object is not predictable. It also allows the user to determine if a noread has occurred.

**Definition:** **External Trigger Level** allows the read cycle (active state) to begin when a trigger (change of state) from an external sensing device is received. The read cycle endures until the object moves out of the sensor range and the active trigger state changes again.

**Serial Cmd:** <K200,2>

**Important:** **Level** and **Edge** apply to the active logic state (Active Off ( $I_{OFF}$ ) or Active On ( $I_{ON}$ )) that exists while the object is in a read cycle, between the rising edge and falling edge. *Rising edge* is the trigger signal associated with the appearance of an object. *Falling edge* is the trigger signal associated with the subsequent disappearance of the object.

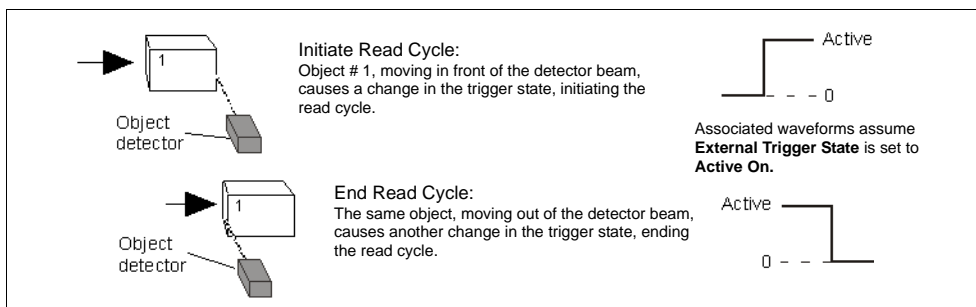

*Trigger Level*

## External Trigger Edge

**Usage:** This mode is highly recommended in any application where conveying speed is constant or if spacing, object size, or timeouts are consistent.

**Definition:** **External Trigger Edge**, as with Level, allows the read cycle (active state) to begin when a trigger (change of state) from an external sensing device is received. However, the passing of an object out of sensor range does not end the read cycle. The read cycle ends with a good read output or, depending on **End of Read Cycle** setting, a timeout or new trigger occurs.

**Serial Cmd:** <K200,3>

**Important:** Level and Edge apply to the active logic state (**Active Off** ( $I_{OFF}$ ) or **Active On** ( $I_{ON}$ )) that exists while the object is in a read cycle, between the rising edge and falling edge. *Rising edge* is the trigger signal associated with the appearance of an object. *Falling edge* is the trigger signal associated with the subsequent disappearance of the object.

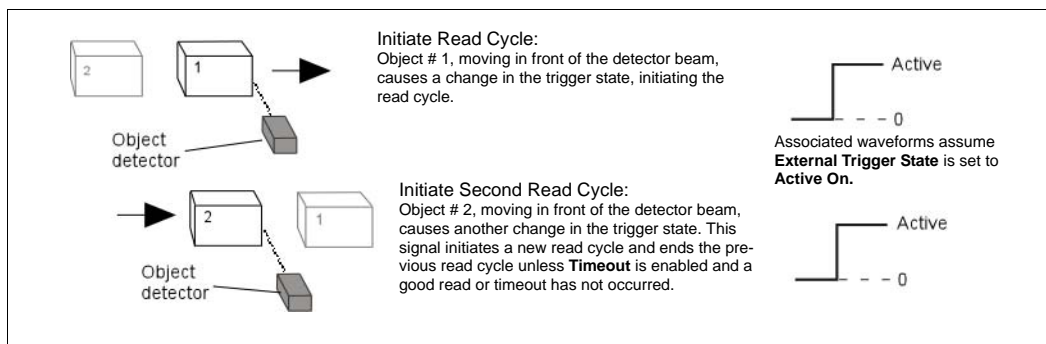

Trigger Edge



## Serial Data

*Usage:* **Serial Data** is effective in a highly controlled environment where the host knows precisely when the object is in the field of view. It is also useful in determining if a noread has occurred.

*Definition:* In **Serial Data**, the reader accepts an ASCII character from the host or controlling device as a trigger to start a read cycle. A **Serial Data** trigger behaves the same as an **External Edge** trigger.

Serial commands are entered inside corner brackets, such as <>.

*Serial Cmd:* <K200,4>

**Note:** In **Serial Data**, sending a non-delimited start serial character will start a read cycle; however a non-delimited stop serial character has no effect.

## Serial Data or External Edge

*Usage:* **Serial Data or External Edge** is seldom used but can be useful in an application that primarily uses an external sensing device but occasionally needs to be manually triggered.

An auxiliary terminal can be connected to the aux port so the user can send the serial trigger character through the reader to the host.

*Definition:* In this mode the reader accepts either a serial ASCII character or an external trigger pulse to start the read cycle.

*Serial Cmd:* <K200,5>

**Note:** In **Serial Data or External Edge**, sending a non-delimited start serial character will start a read cycle; however a non-delimited stop serial character has no effect.

## Trigger Filter Duration

**Usage:** **Trigger Filter Duration** can be used to help the unit trigger more consistently with an unstable external trigger.

**Definition:** **Trigger Filter Duration** can prevent trigger bounce from falsely triggering the reader by limiting the time during which trigger pulses can be received.

**Serial Cmd:** **<K200, trigger mode, trigger filter duration>**

**Default:** **313** (x 32 $\mu$ s = 10.24mS)

**Options:** **0** to **65535** (corresponding to 0 to 2.097seconds in 32 $\mu$ s steps)

If the unit is in External Edge trigger mode, then **Trigger Filter Duration** specifies the time following an edge that the reader will not consider another edge as a valid trigger.

If the unit is in **External Level** mode, then **Trigger Filter Duration** specifies the time following the active edge that the trigger must be sampled once again as active before considering it a valid level trigger.

## External Trigger State

**Usage:** Allows users to select the trigger state that will operate with their systems. (If using an object detector, use **Active Off**.)

**Definition:** When enabled for **Active On (I<sub>ON</sub>)** the triggering device imposes a current on the optoisolator to activate the read cycle. When enabled for **Active Off (I<sub>OFF</sub>)** the triggering device interrupts the current to the optoisolator to activate the read cycle.

**Serial Cmd:** **<K202, external trigger state>**

**Default:** **Active On**

**Options:** 0 = Active Off      1 = Active On

**Note:** **External Level, External Edge, or Serial Data or Edge** triggering mode must be enabled for **External Trigger** to take effect.

## Serial Trigger

- Usage:* Allows the user to define the trigger character and delimiters that start and stop the read cycle.
- Definition:* A serial trigger is considered an online host command and requires the same command format as all host commands: that is, to be entered within angle brackets delimiters **< >** or in the case of non-delimited triggers, define individual start and stop characters.

### **Serial Trigger Character (delimited)**

- Usage:* Allows the user to define the trigger character that initiates the read cycle.
- A single ASCII host serial trigger character that initiates the read cycle.
- Definition:* A delimited trigger character is one that either starts or ends the read cycle and is enclosed by delimiters such as **<** and **>**.
- Serial Cmd:* **<K201, serial trigger character>**
- Default:* **Spacebar** (corresponds to **<SP>** displayed in the embedded menu)
- Options:* Any single ASCII character, including control characters, except **NUL (00H)**, an existing host command character, or an on-line protocol character. Control characters entered on the command line are displayed in the menu as mnemonic characters.

**Note:** **Serial Data** or **Serial Data or Edge** triggering mode must be enabled for **Serial Trigger Character** to take effect.

### **Start and Stop Trigger Characters (non-delimited)**

- Usage:* It is useful in applications where different characters are required to start and end a read cycle.
- A non-delimited trigger character is one that either starts or ends the read cycle and is NOT enclosed by delimiters such as **<** and **>**.
- Both **Start** and **Stop** non-delimited characters can be defined and will function according to the trigger event, as follows:
- When defining **Start** and **Stop** trigger characters, the following rules apply:
- Definition:*
- In **External Edge** the reader looks only for the start trigger character and ignores any end trigger character that may be defined.
  - In **External Level**, the start trigger character begins the read cycle and end trigger character ends it. Note that even after a symbol has been decoded and the symbol data transmitted, the reader remains in **External Level** trigger read cycle until a **Stop** character is received.
  - In **Serial Data & Edge** trigger mode, command, either a start trigger character or a hardware trigger can start an edge trigger read cycle.

## Start Character (non-delimited)

*Definition:* A single ASCII host serial trigger character that starts the read cycle and is not enclosed by delimiters such as < and >.

*Serial Cmd:* <**K229, start character**>

*Default:* **NULL (00** in hex) (disabled)

*Options:* Two hex digits representing an ASCII character except <, >, **XON**, and **XOFF**.

## Stop Character (non-delimited)

*Usage:* It is useful in applications where different characters are required to start and end a read cycle.

*Definition:* A single ASCII host serial trigger character that ends the read cycle and is not enclosed by delimiters such as < and >.

*Serial Cmd:* <**K230, stop character**>

*Default:* **NULL (00** in hex) (disabled)

*Options:* Two hex digits representing an ASCII character except <, >, **XON**, and **XOFF**.

## End of Read Cycle

*Definition:* The read cycle is the time during which the reader will attempt to capture and decode a symbol. A read cycle can be ended by a timeout, a new trigger, or by the last frame in a capture sequence or a combination of the above.

### **End of Read Cycle Mode**

**Note:** When operating in **Continuous Read** or **Continuous Read 1 Output**, the reader is always in the read cycle.

*Serial Cmd:* <**K220, end of read cycle**, read cycle timeout>

*Default:* **Timeout**

0 = Timeout

1 = New Trigger

*Options:* 2 = Timeout or New Trigger

3 = Last Frame

4 = Last Frame or New Trigger

### **Timeout**

Typically used with **Serial Data** or **Edge Trigger** and **Continuous One Output**.

*Usage:* It is effective in highly controlled applications when the maximum length of time between objects can be predicted. It assures that a read cycle ends before the next bar-coded object appears, giving the system extra time to decode and transmit the data to the host.

**Timeout** ends the read cycle, causing the reader to stop reading symbols and send the symbol data or noread message when the time set in **Timeout** elapses (times out), if **When to Output** is set to **End of Read Cycle**.

If in **Continuous Read 1 Output**, a timeout initiates a new read cycle and allows the same symbol to be read again.

*Definition:* With either **External Edge**, **Serial Data**, or **Serial Data & Edge** enabled, a timeout ends the read cycle and symbol data or a noread message is sent to the host.

With **External Level** enabled, the read cycle does not end until the falling edge trigger or a timeout occurs. The next read cycle does not begin until the next rising edge trigger.

## New Trigger

*Usage:* **New Trigger** is an effective way to end a read cycle when objects move past the reader at irregular intervals (not timing dependent).

New Trigger ends the current read cycle and initiates a new one when a new trigger occurs. New Trigger refers only to a “rising edge” trigger.

*Definition:* With either **External Edge**, **Serial**, or **Serial or Edge** enabled, an edge or serial trigger ends a read cycle and initiates the next read cycle.

In the case of **External Level**, a falling edge trigger ends the read cycle but the next read cycle does not begin until the occurrence of the next rising edge trigger.

## Timeout or New Trigger

*Usage:* Useful in applications that require an alternative way to end the read cycle. For example, if an assembly line should stop completely or the intervals between objects are highly irregular.

*Definition:* **Timeout or New Trigger** is identical to **Timeout** except that a timeout or a new trigger (whichever occurs first) ends the read cycle.

## Last Frame

*Usage:* Useful in applications in which the number of captures needed can be defined but the timeout duration varies.

*Definition:* **Last Frame** only applies to **Rapid Capture** mode.

## Last Frame or New Trigger

*Usage:* Useful in applications in which line speeds are irregular and a new labeled object could appear before the last frame in a **Rapid Capture** sequence.

*Definition:* **New Trigger or Last Frame** is identical to **New Trigger** except that a new trigger or last frame (whichever occurs first) ends the read cycle.

## Read Cycle Timeout

*Definition:* **Read Cycle Timeout** is the duration of the read cycle.

*Serial Cmd:* **<K220, end of read cycle, read cycle timeout>**

*Default:* **100** (x 10mS)

*Options:* **0 to 65,535**

## Active Camera

*Usage:* **External** and **Dual** options are useful where in applications where the reader cannot be located near the symbol or where both the internal and external cameras are required for products such as circuit boards that might have two symbols in different locations.

*Definition:* The Quadrus EZ has its own internal camera complete with illumination and led sensor circuitry for capturing static or moving symbols at various camera settings including shutter, contrast, etc.

The Quadrus EZ can also accept images from a remote (external) camera using the RS-170 communications protocol.

*Serial Cmd:* **<K240,active camera>**

*Default:* **Internal**

0 = Internal Camera

*Options:* 1 = External Camera

2 = Dual Camera

**Important:** The Quadrus EZ does not control the timing of external cameras. Captures from external cameras are streamed into the Quadrus EZ. To be sure to receive a complete first capture, allow an extra 33mS delay before the first external capture.

## Capture Mode

**Definition:** **Capture Mode** relates to the way that multiple captures are processed by the Quadrus EZ.

**Serial Cmd:** <K241,capture mode,number of captures,rapid capture mode>

**Default:** **Rapid Capture**

**Options:** 0 = Rapid Capture                      1 = Continuous Capture

### Number of Captures

**Usage:** Used to increase the opportunities for good reads and to “extend” the field of view in dynamic applications.

**Definition:** Sets the total number of captures that are processed during a read cycle in the **Rapid Capture** mode when **Switching Mode** is set to **Number of Captures**.

**Serial Cmd:** <K241,capture mode,number of captures,rapid capture mode>

**Default:** **8**

**Options:** 0 to 8

**Note:** When processing in **Rapid Capture** mode and **Dual Capture** mode, the number of captures set for each camera will be limited by the number of captures set here. For example, if **Number Of Captures** is set to 4, and the individual camera captures are set for 2 and 3 respectively, the last capture will be omitted.

### Rapid Capture Mode

**Usage:** **Rapid Capture** is useful in fast moving applications in which symbols are only in the field of view a short time or precise timing between captures is relevant or when dual camera mode is enabled. A single capture with **Last Frame** ending the read cycle is the same as “single shot.”

**Definition:** In **Rapid Capture**, decoding occurs independent of and simultaneous with capturing, thus allowing precise timing (**Diagram B**) or no delay (**Diagram A**) at all between captures. The downside is that the number of captures is limited to 8 so that processing buffers are not overloaded.

**Serial Cmd:** <K241,capture mode,number of captures,rapid capture mode>

**Default:** **Timed Capture**

**Options:** 0 = Timed Capture                      1 = Triggered Capture



## Timed Capture

**Usage:** **Timed Rapid Capture** is useful in fast moving applications in which symbols are only in the field of view a short time and precise timing is required.

In **Timed Rapid Capture**, decoding occurs independent of and simultaneous with capturing, thus allowing precise timing (**Diagram B**) or no delay (**Diagram A**) at all between captures.

**Definition:** Also, consecutive captures are regarded as the same symbol if the output data is the same.

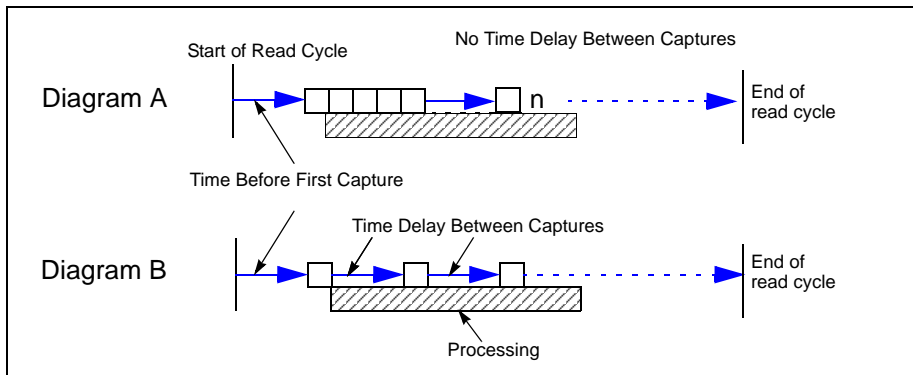

*Rapid Capture Mode, Single Camera*

## Calculating Number of Captures in a Rapid Capture Application

1. First calculate the distance between multiple captures.

For multiple captures in **Rapid Capture** mode, you can calculate the distance between successive symbols by multiplying the line speed by the capture time.

### For CCD:

**TRAVEL DISTANCE = Line Speed X 15mS**

### For CMOS:

**TRAVEL DISTANCE = Line Speed X 30mS**

Capture time is a fixed “overhead” that includes the time of capture and transfer of the image.

**Note:** For **Dual Camera** operations, add 33mS to the overhead time for the first external capture.

### Example:

A symbol moving at 10 ips (inches per second) past a CCD reader travels  $0.010''/mS * 15mS = 0.15$  inches between captures.

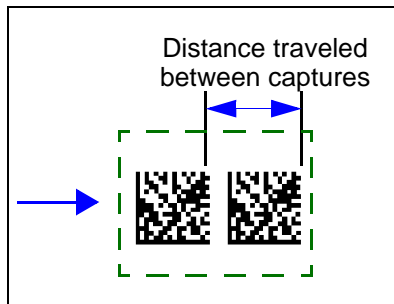

2. Next calculate number of captures.

Once the travel time is known, you can easily calculate the number of captures you can expect to occur inside a FOV by subtracting the symbol size from the FOV and dividing the result by the travel time.

**NUMBER OF CAPTURES =**

**(FOV–Symbol Size)/Travel Distance**

Following up on the example from Step 1:

$$0.78'' - 0.4''/0.15'' = 2.5 \text{ captures}$$

If a required number of captures has been determined, you can also work the formula backwards and determine the minimum FOV by:

**FOV = (Number Of Captures \* Travel Time) + Symbol Size**

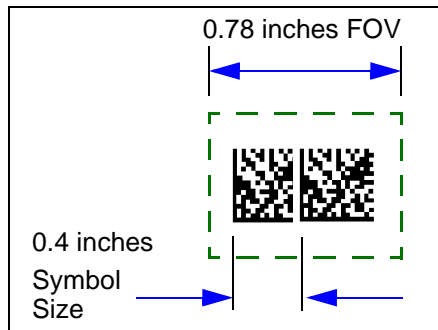

## Triggered Capture

**Usage:** Useful in applications where delays between captures can be controlled by triggers rather than preset time delays.

**Definition:** When enabled the reader will stay in the read cycle until either the user-defined number of captures has been met or, if configured, a timeout occurs.

### Notes on Triggered Capture Mode:

1. **Trigger Mode** <K200> must be set to **Edge**, **Serial**, or **Serial & Edge**. If set to **Level**, **Triggered Capture Mode** will operate the same as **Timed Rapid Capture** mode.
2. For **End of Read Cycle** settings <K220>:
  - a) If set to **Timeout** or **New Trigger & Timeout** and a timeout occurs before number of capture have been met, it will abort the read cycle and disregard the remaining number of triggers.
  - b) If set to **New Trigger**, the reader remains in the read cycle until the number of captures is satisfied and an additional trigger is received indicating both the end of the read cycle and the start and first capture of the next read cycle.

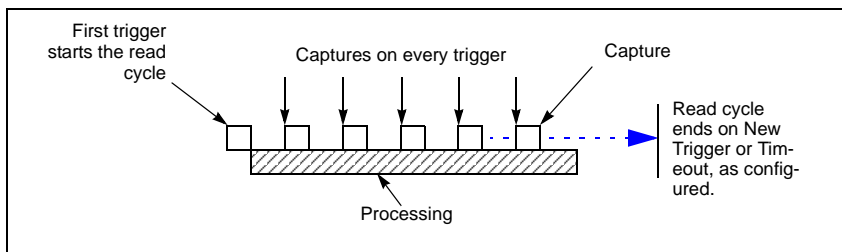

*Triggered Captures, Typical*

## Continuous Capture

**Usage:** **Continuous Capture** is useful in applications with slower line speeds or where symbol spacing may be random or not time-dependent.

**Definition:** In **Continuous Capture** a capture is followed sequentially by processing as shown above. Since processing is completed before another capture can occur (this usually takes about 30mS), a large number of captures can take place throughout a read cycle.

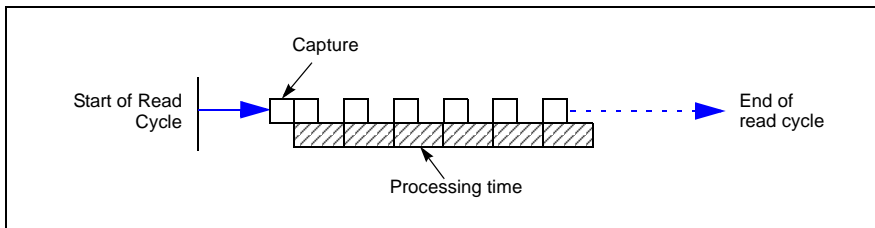

*Continuous Capture*

# Capture Timing

**Note:** Capture Timing applies only to **Rapid Capture** mode.

## Time Before 1st Capture

**Usage:** In almost any moving line application, a time delay is needed to ensure that a symbol will be in the reader's field of view at the beginning of the capture sequence.

**Definition:** **Time Before 1st Capture** in a moving line application is the time between an external trigger event and the occurrence of the first capture.

**Serial Cmd:** <**K242, time before 1st capture**,time between capture 1 and 2,,,,,,,time between capture 7 and 8>

**Default:** **0**

**Options:** 0 to 65535 (2.097seconds, in 32 $\mu$ S increments)

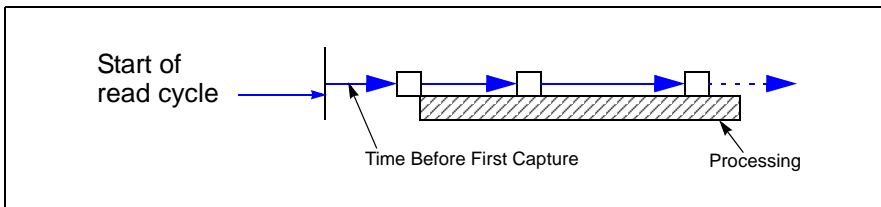

*Time Before First Capture*

## Time Between Captures

**Usage:** This is useful in applications where more than one symbol can appear during a single read cycle (multisymbol), or where line speeds are slow enough that captured frames might overlap or miss a symbol.

**Definition:** A time delay can be inserted between individual frame captures in the **Rapid Capture** mode.

<K242,time before 1st capture,time between captures  
[time1,time2,...time7]>

Entering 0's will result in no time between captures (**Diagram A**).

**Serial Cmd:** Entering a different value in each field will vary the time delays accordingly. (**Diagram B**)

**Note:** You must enter time values along with comma separators for each field you want to change. If you omit fields, or enter only commas, the fields will remain as previously set.

**Default:** 0

**Options:** 0 to 65535 (2.097seconds, in 32µS increments)

**Note: Number of Captures** and number of delays (**Time Between Captures**) must be the same.

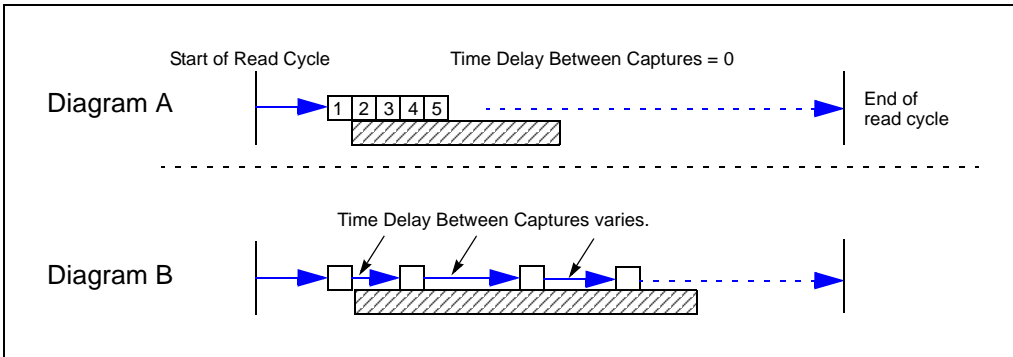

*Time Delay Between Captures*

## Dual Camera Switching

**Note:** The following options are only available when **Active Camera** is set to **Dual**.

*Usage:* Useful where different symbols can appear within a single read cycle.

*Definition:* When **Active Camera** is set to **Dual**, captures will alternate between the internal and external cameras, starting with the internal camera.

**Important Note:** The Quadrus EZ does not control the timing of external cameras. Captures from external cameras are streamed into the Quadrus EZ. To be sure to receive a complete first capture, allow up to 33mS delay before the first external capture.

### Switching Mode

When **Switching Mode** is set to **Number of Captures**, the combined internal and external camera captures can not exceed the total number set in **Number of Captures**; however if the combined total is less than the total, then the capture pattern will be repeated until the total number of captures has been met.

*Definition:* Captures can be set to alternate between the internal and external cameras by the number of captures or by camera timeouts.

*Serial Cmd:* <**K243,switching mode,number of internal captures,number of external captures,internal camera timeout,external camera timeout**>

*Default:* **Number of Captures**

*Options:* 0 = Number Of Captures

1 = Timeout

### Switching by Number of Captures

#### Number of Internal Camera Captures

*Definition:* The number of captures taken by the internal camera before switching to the external camera.

*Serial Cmd:* <**K243,switching mode,number of internal captures,number of external captures,internal camera timeout,external camera timeout**>

*Default:* **1**

*Options:* 1 to 8

## Number of External Camera Captures

- Usage:** Useful where two cameras can expect different symbols within a given read cycle.
- Definition:** The number of captures taken by the external camera before switching to the external camera.
- Serial Cmd:** <K243,switching mode,number of internal captures,**number of external captures**,internal camera timeout,external camera timeout>
- Default:** 1
- Options:** 1 to 8

### Rapid Capture Mode Examples

Since examples 1 and 2 are in **Rapid Capture** mode, the cameras will continue to switch until the **Number Of Captures** setting has been met.

#### Example # 1

Time Between Captures = 0, Active camera: **Dual**

Capture mode: **Rapid**, Number of captures = 7

Number of internal camera captures = 5

Number of external camera captures = 3

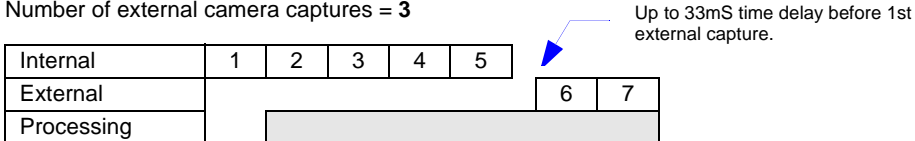

**Note:** The third capture for the external camera does not occur because the total number of captures (7) has been met.

**Note:** In this mode, the first capture from an external camera (#6 is the above example) could be delayed for up to 33mS until the external camera synchronizes with the reader.

#### Example # 2

Time Between Captures = 0, Active Camera: **Dual**

Capture Mode: **Rapid**, Number of captures = 8

Number of internal camera captures = 2

Number of external camera captures = 3

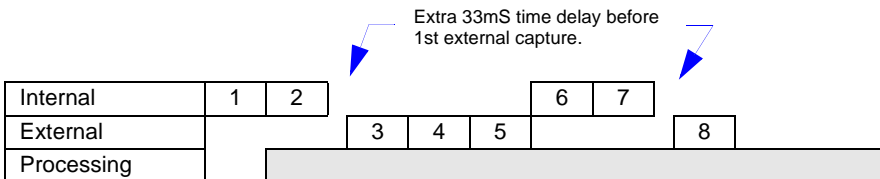

**Note:** Since the total number of captures is greater than the combined number of captures of both cameras, capture source will oscillate between the two cameras until the total number (8) has been met.



## Continuous Capture Mode Examples

**Continuous Capture** mode is more involved due to the double buffering. The cameras will continue to switch for the duration of the read cycle in a double-buffered format, so that we start processing the first image while we are capturing the second. The third image will then start when both the first one is completely processed and the second is completely transferred.<sup>1</sup>

### Example # 3

Time Between Captures = 0, Capture Mode: **Dual Camera**

Number of internal camera captures = 5

Number of external camera captures = 3

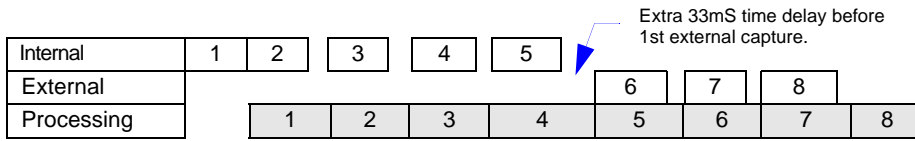

### Example # 4

Time Between Captures = 0, Capture Mode: **Dual Camera**

Number of internal camera captures = 1

Number of external camera captures = 1

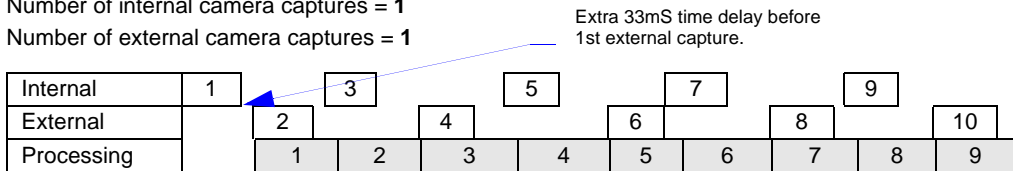

1. Because of space limitations, only 8 captures are shown in the Continuous examples.

## Switching by Timeout

The timeout mode specifies the time each camera is active before switching to the other camera. The read cycle will start with the internal camera and switch to the external camera after the specified time period has expired.

### Internal Camera Timeout

- Usage:* It is useful in many tightly controlled applications which require a read cycle to end before the next object appears and therefore need the flexibility of a timeout adjustment.
- Definition:* **Internal Camera Switching Time** is the time span of the read cycle and is represented in 10mS increments. It is used in conjunction with **External Edge** or **Serial Trigger**.
- Serial Cmd:* <**K243**,switching mode,number of internal captures,number of external captures,**internal camera timeout**,external camera timeout>
- Default:* **100** (x 10mS = 1 second)
- Options:* 0 to 65535. (Divide any positive number entered by 100 to determine the time in seconds.)

### External Camera Timeout

- Usage:* It is useful in many tightly controlled applications which require a read cycle to end before the next object appears and therefore need the flexibility of a timeout adjustment.
- Definition:* **External Camera Timeout** is the time allotted to the external camera and is represented in 10mS increments.
- Serial Cmd:* <**K243**,switching mode,number of internal captures,number of external captures,internal camera timeout,**external camera timeout**>
- Default:* **100** (x 10mS = 1 second)
- Options:* 0 to 65535. (Divide any positive number entered by 100 to determine the time in seconds.)

**Note:** A minimum setting of **2** is recommended.

**Note:** **Timeout** or **Timeout** or **New Trigger** under **End of Read Cycle** must be enabled for **Timeout Duration** to take effect.

## Example of Timeout in Rapid Capture Mode

Since example 5 is in **Rapid Capture** mode, the cameras will continue to switch until the **Number Of Captures** setting has been met.

### Example # 5

Time Between Captures = 0

Capture Mode: **Dual Camera**

Number of captures = 6

Internal camera timeout = **170mS**

External camera timeout = **160mS**

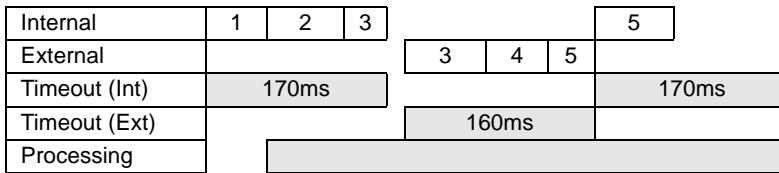

**Note:** The third and fifth captures were never completed since the active camera's timeout occurred during the capture. When this occurs the capture is aborted and the active camera is switched.

## Example of Timeout in Continuous Capture Mode

**Continuous Capture** mode is a little more involved due to the double buffering. The cameras will continue to switch for the duration of the read cycle in a double-buffered format, so that we start processing the first image while we are capturing the second. The third image will then start when both the first one is completely processed and the second is completely transferred.

### Example # 6

Time Between Captures = 0

Capture Mode: **Dual Camera**

Internal camera timeout = **100mS**

External camera timeout = **160mS**

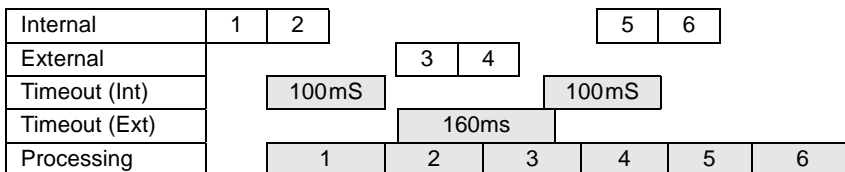

## Store Noread Image

**Note:** Stored images will be lost whenever RAM is reset by re-powering or reset/save sequences, the capture mode is changed, or a read rate mode is initiated.

**Usage:** Useful for evaluating symbols and visually comparing images captured at various settings and conditions.

**Definition:** Images that are captured and processed but are not decoded may be stored for subsequent evaluation.

**Function:** The number of available slots for storage depends on the capture mode. If in **Rapid Capture**, the number of images available for storage is the **Rapid Capture** maximum (which is 8) less the number actually set in **Capture Number**. For example, if **Capture Number** is set to **6**, then only **2** images will be available for storage. If in **Continuous Capture** mode, the number of images available for storage is the maximum number set in **Capture Number** less 3.

### Image Storage Type

**Usage:** Useful for evaluating symbols and visually comparing images captured at various settings.

**Definition:** When **Disabled** is selected, all saved images will be cleared and no further images will be stored unless **Store on Noread** is selected.

**Serial Cmd:** `<K244,image storage type,image storage mode>`

**Default:** **Disabled**

**Options:** 0 = Disabled/Clear                      1 = Store on Noread

### Image Storage Mode

Outputs the first or last noread images, as selected.

**Definition:** In **First** mode, images will be stored until the available image memory has been filled. At this point the unit will stop storing additional images and the first images stored will be available.

In **Last** mode, the last images stored will be available. After the available memory has been filled, images will continue to be stored by purging the oldest image in the storage memory.

**Serial Cmd:** `<K244,image storage type,image storage mode>`

**Default:** **First**

**Options:** 0 = First Images                      1 = Last Images

# 4 Symbologies

## Contents

Symbologies by ESP .....	4-2
Symbologies Serial Commands .....	4-3
Data Matrix .....	4-4
QR Code.....	4-7
Code 39.....	4-8
Code 128.....	4-11
BC412.....	4-12
Interleaved 2 of 5.....	4-14
UPC/EAN.....	4-17
Pharmacode .....	4-20
RSS Expanded.....	4-22
RSS Limited.....	4-23
RSS-14.....	4-24
PDF417 .....	4-25
MicroPDF417.....	4-27
Composite .....	4-28
Narrow Margins .....	4-29
Symbology ID .....	4-30
Background Color.....	4-31

This section describes the various symbol types that can be read and decoded by the Quadrus EZ Reader.

**Note:** When assigning characters in user-defined fields, the characters **NULL <>** and **,** can only be entered through embedded menus, not through **ESP** or serial commands.

See <http://www.aimglobal.org/standards/aimpubs.asp>

and <http://www.gs1us.org/gs1us.html> for additional information about symbologies.

# Symbologies by ESP



Click this button to bring up the **Symbologies** menu.

To open nested options, **single-click** the +.

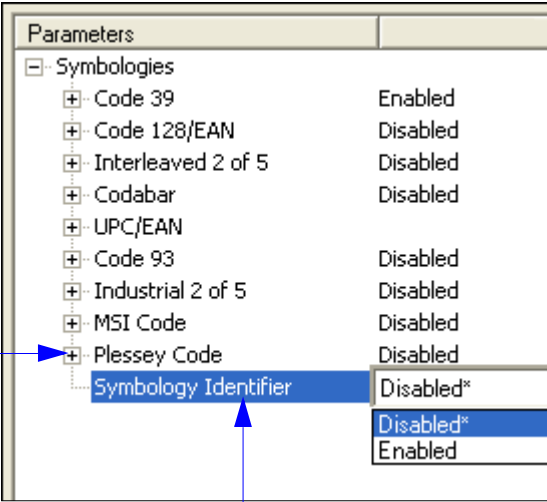

The screenshot shows a 'Parameters' dialog box with a tree view under 'Symbologies'. The following table represents the data shown in the dialog:

Symbology	Status
Code 39	Enabled
Code 128/EAN	Disabled
Interleaved 2 of 5	Disabled
Codabar	Disabled
UPC/EAN	
Code 93	Disabled
Industrial 2 of 5	Disabled
MSI Code	Disabled
Plessey Code	Disabled
Symbology Identifier	Disabled*
	Disabled*
	Enabled

To change a setting, **double-click** the setting and use your cursor to scroll through the options.

## Symbologies Serial Commands

Data Matrix	<K479, ECC 200 status, ECC 000 status, ECC 050 status, ECC 080 status, ECC100 status, ECC140 status, ECC 120 status, ECC 130 status>
QR Code	<K480, status>
Code 39	<K470, status, check digit status, check digit output status, large intercharacter gap, fixed symbol length status, fixed symbol length, full ASCII set>
Code 128	<K474, status, fixed symbol length status, fixed symbol length>
BC412	<K481, status, check digit output, fixed symbol length status, fixed symbol length>
Interleaved 2 of 5	<K472, status, check digit status, check digit output, symbol length #1, symbol length #2, guard bar>
UPC/EAN	<K473, UPC status, EAN status, supplementals status, separator status, separator character, supplemental type>
Pharmacode	<K477, status, fixed symbol length status, fixed symbol length, min. no. of bars, bar width status, direction, fixed threshold value>
RSS Expanded	<K484, status, fixed symbol length status, fixed symbol length>
RSS Limited	<K483, status>
RSS-14	<K482, status>
PDF417	<K476, status, [unused], fixed symbol length status, fixed symbol length, [unused], codeword collection>
Micro PDF417	<K485, status, [unused], fixed symbol length status, fixed symbol length>
Composite	<K453, mode, separator status, separator>
Narrow Margins/ Symbology ID	<K450, narrow margins, symbology identifier status>
Background Color	<K451, background color>

# Data Matrix

*Usage:* Very useful where information needs to be packed into a small area and/or where symbols need to be applied directly to the substrate with etching, dot peen, or other methods.

Data Matrix is a type of Matrix symbology and has subsets ECC 000 — 200.

*Definition:* ECC 200 symbols have an even number of rows and an even number of columns. Most of the symbols are square with sizes from 10 x 10 to 144 x 144. Some symbols however are rectangular with sizes from 8 x 18 to 16 x 48. All ECC 200 symbols can be recognized by the upper right corner module being light (binary 0).

## ECC 200

*Definition:* When enabled will decode ECC 200 symbols.

*Serial Cmd:* <**K479**,**ECC 200 status**,*ECC 000 status,ECC 050 status,ECC 080 status,ECC 100 status,ECC 140 status,ECC 120 status,ECC 130 status*>

*Default:* **Enabled**  
**Note:** This is the only symbol type enabled by default.

*Options:* 0 = Disabled      1 = Enabled

## ECC 000

*Definition:* When enabled will decode ECC 000 symbols

*Serial Cmd:* <**K479**,*ECC 200 status*,**ECC 000 status**,*ECC 050 status,ECC 080 status,ECC 100 status,ECC 140 status,ECC 120 status,ECC 130 status*>

*Default:* **Disabled**

*Options:* 0 = Disabled      1 = Enabled



## **ECC 050**

*Definition:* When enabled will decode ECC 050 symbols.

*Serial Cmd:* <**K479**,ECC 200 status,ECC 000 status,**ECC 050 status**,ECC 080 status,  
ECC 100 status,ECC 140 status,ECC 120 status,ECC 130 status>

*Default:* **Disabled**

*Options:* 0 = Disabled 1 = Enabled

## **ECC 080**

*Definition:* When enabled will decode ECC 080 symbols.

*Serial Cmd:* <**K479**,ECC 200 status,ECC 000 status,ECC 050 status,**ECC 080 status**,  
ECC 100 status,ECC 140 status,ECC 120 status,ECC 130 status>

*Default:* **Disabled**

*Options:* 0 = Disabled 1 = Enabled

## **ECC 100**

*Definition:* When enabled will decode ECC 100 symbols.

*Serial Cmd:* <**K479**,ECC 200 status,ECC 000 status,ECC 050 status,ECC 080 status,  
**ECC 100 status**,ECC 140 status,ECC 120 status,ECC 130 status>

*Default:* **Disabled**

*Options:* 0 = Disabled 1 = Enabled

## **ECC 140**

*Definition:* When enabled will decode ECC 140 symbols.

*Serial Cmd:* <**K479**,ECC 200 status,ECC 000 status,ECC 050 status,ECC 080 status,  
ECC 100 status,**ECC 140 status**,ECC 120 status,ECC 130 status>

*Default:* **Disabled**

*Options:* 0 = Disabled 1 = Enabled

## **ECC 120**

**Note:** ECC 120 is a legacy symbol and NOT part of the ISO/IEC 16022 standard.

*Definition:* When enabled will decode ECC 120 symbols

*Serial Cmd:* <**K479**,ECC 200 status,ECC 000 status,ECC 050 status,ECC 080 status,  
ECC 100 status,ECC 140 status,**ECC 120 status**,ECC 130 status>

*Default:* **Disabled**

*Options:* 0 = Disabled      1 = Enabled

## **ECC 130**

**Note:** ECC 130 is a legacy symbol and NOT part of the ISO/IEC 16022 standard.

*Definition:* When enabled will decode ECC 130 symbols

*Serial Cmd:* <**K479**,ECC 200 status,ECC 000 status,ECC 050 status,ECC 080 status,  
ECC 100 status,ECC 140 status,ECC 120 status,**ECC 130 status**>

*Default:* **Disabled**

*Options:* 0 = Disabled      1 = Enabled

---

## QR Code

- Usage:* Widely implemented in the automotive industry in Japan and throughout their worldwide supply chain.
- The QR Code is capable of handling numeric, alphanumeric, byte data as well as Japanese kanji and kana characters. Up to 7,366 characters (numeric data) can be encoded using this symbol. Therefore, less space is required to encode the same amount of data in the QR Code than in a conventional symbol, helping to reduce the size of a symbol and lower the paper costs.
- Definition:* Three Position Detection Patterns in the symbol make omnidirectional ultra fast reading possible.
- QR Code has error correction capability. Data can be frequently be restored even if a part of the symbol has become dirty or been damaged.
- Serial Cmd:* <**K480,status**>
- Default:* **Disabled**
- Options:* 0 = Disabled      1 = Enabled

## Code 39

- Usage:** **Code 39** is considered the standard for non-retail symbology.
- Definition:** An alphanumeric symbology with unique start/stop code patterns, composed of 9 black and white elements per character, of which 3 are wide.
- Serial Cmd:** *<K470, status, check digit status, check digit output status, large intercharacter gap, fixed symbol length status, fixed symbol length, full ASCII set>*
- Default:** **Disabled**
- Options:** 0 = Disabled      1 = Enabled

### Check Digit Status (Code 39)

- Serial Cmd:** *<K470, status, check digit status, check digit output, large intercharacter gap, fixed symbol length status, fixed symbol length, full ASCII set>*
- Default:** **Disabled**
- Options:** 0 = Disabled      1 = Enabled

### Check Digit Output Status (Code 39)

- Usage:** **Check digit Output**, added to the symbol, provides additional security. When enabled, the check digit character is read and compared along with the symbol data. When disabled, symbol data is sent without the check digit.
- Definition:** **Note:** With **Check Digit Output** and an **External** or **Serial** trigger option enabled, an invalid check digit calculation will cause a noread message to be transmitted at the end of the read cycle.
- Serial Cmd:** *<K470, status, check digit status, check digit output, large intercharacter gap, fixed symbol length status, fixed symbol length, full ASCII set>*
- Default:** **Disabled**
- Options:** 0 = Disabled      1 = Enabled

## Large Intercharacter Gap (Code 39)

**Large Intercharacter Gap** is helpful for reading symbols that are printed out of specification.

**Usage:** **Caution:** Do not use **Large Intercharacter Gap** with **Narrow Margins** enabled since a large intercharacter gap (over 3x) could cause a narrow margins (5x) to be interpreted as an intercharacter gap.

**Definition:** When enabled, the reader can read symbols with gaps between symbol characters that exceed three times (3x) the narrow element width.

**Serial Cmd:** <**K470**, status,check digit status,check digit output,**large intercharacter gap**,fixed symbol length status,fixed symbol length,full ASCII set>

**Default:** **Disabled**

**Options:** 0 = Disabled      1 = Enabled

## Fixed Symbol Length Status (Code 39)

**Definition:** When enabled the reader will check the symbol length against the symbol length field. If disabled any length would be considered a valid symbol.

**Serial Cmd:** <**K470**, status,check digit status,check digit output,large intercharacter gap,**fixed symbol length status**,fixed symbol length,full ASCII set>

**Default:** **Disabled**

**Options:** 0 = Disabled      1 = Enabled

## Fixed Symbol Length (Code 39)

**Usage:** **Fixed Symbol Length** helps prevent truncations and increases data integrity by ensuring that only one symbol length will be accepted.

**Definition:** Specifies the exact number of characters that the reader will recognize (this does not include start and stop and check digit characters). The reader ignores any symbology not having the specified length.

**Serial Cmd:** <**K470**, status,check digit status,check digit output,large intercharacter gap,fixed symbol length status,**fixed symbol length**,full ASCII set>

**Default:** **10**

**Options:** 1 to 128

## **Full ASCII Set (Code 39)**

Must be enabled when reading characters outside the standard character set (0-9, A-Z, etc.)

*Usage:* User must know in advance whether or not to use **Full ASCII Set** option. Since **Full ASCII Set** requires two code words to encode one character, it is less efficient.

*Definition:* Standard Code 39 encodes 43 characters; zero through nine, capital "A" through capital "Z", minus symbol, plus symbol, forward slash, space, decimal point, dollar sign and percent symbol. When **Full ASCII Set** is enabled, the reader can read the full ASCII character set, from 0 to 255.

*Serial Cmd:* **<K470, status, check digit status, check digit output, large intercharacter gap, fixed symbol length status, fixed symbol length, full ASCII set>**

*Default:* **Disabled**

*Options:* 0 = Disabled      1 = Enabled

## Code 128

**Usage:** **Code 128** is a smaller symbology useful in applications with tight spots and high security needs.

**Definition:** A very dense alphanumeric symbology. It encodes all 128 ASCII characters, it is continuous, has variable length, and uses multiple element widths measured edge to edge.

**Serial Cmd:** <**K474,status,fixed symbol length status,fixed symbol length**>

**Default:** **Disabled**

**Options:** 0 = Disabled      1 = Enabled

### **Fixed Symbol Length Status (Code 128)**

**Definition:** When enabled the reader will check the symbol length against the symbol length field. If disabled any length would be considered a valid symbol.

**Serial Cmd:** <**K474, status,fixed symbol length status,fixed symbol length**>

**Default:** **Disabled**

**Options:** 0 = Disabled      1 = Enabled

### **Fixed Symbol Length (Code 128)**

**Usage:** **Fixed Symbol Length** helps prevent truncations and increases data integrity by ensuring that only one symbol length will be accepted.

**Definition:** It specifies the exact number of characters that the reader will recognize (this does not include start and stop and check digit characters). The reader ignores any symbol not having the specified length.

**Serial Cmd:** <**K474, status,fixed symbol length status,fixed symbol length**>

**Default:** **10**

**Options:** 1 to 128

**Note:** **Fixed Symbol Length Status** must be enabled for **Fixed Symbol Length** to take effect.

# BC412

- Usage:** It is widely used in the semi-conductor manufacturing and is particularly useful where speed, accuracy, and ease of printing are required.
- Definition:** BC412 (Binary Code 412), a proprietary IBM symbology since 1988, is an alphanumeric symbol with a set of 35 characters, each encoded by a set of 4 bars in 12 module positions. All bars have a single width and it is the presence or absence of bars in each of the 12 module positions that makes it a binary code (hence the prefix "BC").  
The symbology is bi-directional and self-clocking with a start and stop character.
- Serial Cmd:** <**K481**,*status*,*check digit output*,*fixed symbol length status*,*fixed symbol length*>
- Default:** **Disabled**
- Options:** 0 = Disabled      1 = Enabled

## Check Digit Output (BC412)

- Usage:** **Check digit Output**, added to the symbol, provides additional security. When enabled, the check digit character is read and compared along with the symbol data. When disabled, symbol data is sent without the check digit.
- Definition:** **Note:** With **Check Digit Output** and an **External** or **Serial** trigger option enabled, an invalid check digit calculation will cause a noread message to be transmitted at the end of the read cycle.
- Serial Cmd:** <**K481**,*status*,*check digit output*,*fixed symbol length status*,*fixed symbol length*>
- Default:** **Disabled**
- Options:** 0 = Disabled      1 = Enabled



## Fixed Symbol Length Status (BC412)

- Definition:** When enabled the reader will check the symbol length against the symbol length field. If disabled any length would be considered a valid symbol.
- Serial Cmd:** <K481, status, check digit output, **fixed symbol length status**, fixed symbol length>
- Default:** **Disabled**
- Options:** 0 = Disabled          1 = Enabled

## Fixed Symbol Length (BC412)

- Usage:** **Fixed Symbol Length** helps prevent truncations and increases data integrity by ensuring that only one symbol length will be accepted.
- Definition:** Specifies the exact number of characters that the reader will recognize (this does not include start and stop and check digit characters). The reader ignores any symbology not having the specified length.
- Serial Cmd:** <K481, status, check digit output, fixed symbol length status, **fixed symbol length**>
- Default:** **10**
- Options:** 1 to 64

## Interleaved 2 of 5

*Usage:* It is has been popular because it is the most dense symbology for printing numeric characters less than 10 characters in length; however, Microscan does not recommend this symbology for any new applications because of inherent problems such as truncation.

*Definition:* A dense, continuous, self-checking, numeric symbology. Characters are paired together so that each character has five elements, two wide and three narrow, representing numbers 0 through 9, with the bars representing the first character and the interleaved spaces representing the second character. (A check digit is highly recommended.)

**Important:** You must set **Symbol Length** in order to decode I 2/5 symbols.

*Serial Cmd:* <**K472,status,check digit status,check digit output,symbol length #1,symbol length #2**>

*Default:* **Disabled**

*Options:* 0 = Disabled          1 = Enabled

### Check Digit Status (Interleaved 2 of 5)

*Usage:* It is typically not used but can be enabled for additional security in applications where the host requires redundant check digit verification.

*Definition:* An error correcting routine in which the check digit character is added.

*Serial Cmd:* <**K472,status,check digit status,check digit output,symbol length #1,symbol length #2**>

*Default:* **Disabled**

*Options:* 0 = Disabled          1 = Enabled

### Check Digit Output Status (Interleaved 2 of 5)

*Definition:* When enabled, a check digit character is sent along with the bar symbol data for added data security.

*Serial Cmd:* <**K472,status,check digit status,check digit output,symbol length #1,symbol length #2**>

*Default:* **Disabled**

*Options:* 0 = Disabled          1 = Enabled

## Symbol Length #1 (Interleaved 2 of 5)

- Usage:** With I 2/5, two symbol lengths can be defined. When using only one symbol length in an application, setting **Symbol Length #2** to 0 (zero) to ensure data integrity is recommended.
- Definition:** Allows user to define the symbol length. Because I 2/5 is a continuous symbology, it is prone to substitution errors. Hence, a symbol length must be defined and a bar code symbol must contain an even number of digits.
- Note:** If a start, stop or check digits are used, they are not included in the symbol length count.
- Serial Cmd:** <K472, status, check digit status, check digit output, **symbol length #1**, symbol length #2>
- Default:** **10**  
2 to 128, even.
- Since I 2/5 characters are paired, symbol length must be set to an even number. If **Check Digit** is enabled, add **2** to your symbol length. For example, if your symbol is 10 characters plus a check digit, then enable **Symbol Length#1** for **12**.
- Options:** **Note:** Typically, when printing an I 2/5 symbol with an odd number of digits, a 0 will be added as the first character.
- Note:** If both **Symbol Length # 1** and **Symbol Length # 2** are set to **0**, then I-2/5 will be variable.

## Symbol Length #2 (Interleaved 2 of 5)

- Usage:** If using a second symbol, a zero or any even symbol length from **2** to **64** may be specified. If not using a second symbol, set **Symbol Length #2** to **0** to ensure data integrity.
- Definition:** Allows user to define a second symbol length for Interleaved 2 of 5.
- Serial Cmd:** <K472, status, check digit status, check digit output, symbol length #1, **symbol length #2**>
- Default:** **6**  
2 to 128, even.
- Since Interleaved 2 of 5 characters are paired, symbol length must be set to an even number. If **Check Digit** is enabled, add **2** to your symbol length. For example, if your symbol is **10** characters plus a check digit, then enable **Symbol Length** for **12**.
- Options:** **Note:** Typically, when printing an I 2/5 symbol with an odd number of digits, a **0** will be added as the first character.
- Note:** If both **Symbol Length #1** and **Symbol Length #2** are set to **0**, then I-2/5 will be variable.

## **Guard Bar (Interleaved 2 of 5)**

**Note:** Whenever Guard Bar is enabled, the presence of guard bars is required for decoding to take place.

*Usage:* It is useful when I 2 of 5 multisymbols are enabled to prevent false data output. This typically occurs with highly tilted or skewed symbols.

*Definition:* A guard bar is a heavy bar, at least 2 times the width of the wide bar, surrounding the printed I 2 of 5 symbol and helping to prevent false reads.

*Serial Cmd:* <**K472**, status, check digit status, check digit output status, symbol length #1, symbol length #2, **guard bar**>

*Default:* **Disabled**

*Options:* 0 = Disabled          1 = Enabled

## UPC/EAN

<i>Usage:</i>	Used primarily in POS application in the retail industry. It is commonly used with Microscan readers in applications in combination with <b>Matchcode</b> when there is a need to verify that the right product is being placed in the right packaging.
<i>Definition:</i>	UPC (Universal Product Code) is a fixed length numeric, continuous symbology. UPC can have two- or five-digit supplemental bar code data following the normal code. The U.P.C., Version A (U.P.C., A) symbol is used to encode a 12 digit number. The first digit is the number system character, the next five are the manufacturer number, the next five are the product number, and the last digit is the checksum character. When enabled, the scanner will read UPC version A and UPC version E only.
<i>Serial Cmd:</i>	< <b>K473</b> , <b>UPC status</b> , <i>EAN status</i> , <i>supplementals status</i> , <i>separator status</i> , <i>separator character</i> , <i>supplemental type</i> >
<i>Default:</i>	<b>Disabled</b>
<i>Options:</i>	0 = Disabled            1 = Enabled

## EAN Status

<i>Usage:</i>	<b>EAN</b> is the European version of the UPC symbology and is used in European market applications.
<i>Definition:</i>	<b>Note:</b> <b>UPC</b> must be enabled for <b>EAN</b> to take effect. EAN is a subset of UPC. When enabled, the scanner will read UPC version A, UPC version E, EAN 13, and EAN 8. It also appends a leading zero to UPC version A symbol information and transmits 13 digits. If transmitting 13 digits when reading UPC version A symbols is not desired, disable <b>EAN</b> . <b>Note:</b> The extra character identifies the country of origin.
<i>Serial Cmd:</i>	< <b>K473</b> , <i>UPC status</i> , <b>EAN status</b> , <i>supplementals status</i> , <i>separator status</i> , <i>separator character</i> , <i>supplemental type</i> >
<i>Default:</i>	<b>Disabled</b>
<i>Options:</i>	0 = Disabled            1 = Enabled

## Supplementals Status (UPC/EAN)

- Usage:** Reads **Supplementals** typically used in publications and documentation. A supplemental is a 2 or 5 digit symbol appended to the main symbol.
- Definition:** When set to **Enabled** or **Required**, the scanner reads supplemental bar code data that has been appended to the standard UPC or EAN codes.
- Serial Cmd:** <K473,UPC status,EAN status,**supplementals status**,separator status,separator character,supplemental type>
- Default:** **Disabled**
- Options:** 0 = Disabled            1 = Enabled            2 = Required

### Disabled

UPC **Supplementals** will not be decoded.

### Enabled

When enabled, the scanner will try to decode a main and a supplemental. However, if a supplemental is not decoded, at the end of the read cycle, the main will be sent by itself.

### Required

When set to **Required**, both the main and the supplemental symbols must be read or a single noread condition results.

For example, if **Supplementals** is set to **Required**, **Separator** is enabled, and an asterisk is defined as the UPC separator character, then the data will be displayed as: MAIN \* SUPPLEMENTAL.

**Note:** Under no circumstances will the supplemental symbol data be sent without a main symbol.

**Note:** If additional symbols—other than the main or supplemental—will be read in the same read cycle, **Number of Symbols** should be set accordingly.

## Separator Status (UPC/EAN)

- Usage:** Allows user to distinguish between the main and **Supplemental** symbols. Allows the user to insert a character between the standard UPC or EAN symbology and the supplemental symbology when **Supplementals** is set to **Enabled** or **Required**.
- Definition:** When set to **Enabled** or **Required**, the scanner reads supplemental bar code data that has been appended to the standard UPC or EAN codes.
- Serial Cmd:** <K473,UPC status,EAN status,supplementals status,**separator status**,separator character,supplemental type>
- Default:** **Disabled**
- Options:** 0 = Disabled            1 = Enabled

## Separator Character (UPC/EAN)

**Note:** If **Separator Character** has been changed to any other character and you wish to re-define the separator as a comma, you will need to use **ESP** or the embedded menu.

**Usage:** As required by the application.

**Definition:** Allows the user to change the separator character from a comma to a new character.

**Serial Cmd:** <**K473**,UPC status,EAN status,supplementals status,separator status,separator character,supplemental type>

**Default:** , (comma)

**Options:** Any ASCII character

**Note:** Whenever **Separator Character** is defined as a comma (,) sending a <**K473,s?**> command will return the current settings including the separator character comma which appears after the separator status comma.

## Supplementals Type (UPC/EAN)

**Usage:** As required by symbology used in application.

**Definition:** Allows the user to select 2 character or 5 character supplements, or both.

**Serial Cmd:** <**K473**,UPC status,EAN status,supplementals status,separator status,separator character,supplemental type>

**Default:** **Both**

**Options:** 0 = Both                      1 = 2 char only                      2 = 5 char only

### **Both**

Either 2 character or 5 character supplementals will be considered valid.

### **2 Characters Only**

Only two character supplementals will be considered valid.

### **5 Characters Only**

Only five character supplementals will be considered valid.

# Pharmacode

- Usage:** Used mostly with packaging for the pharmaceuticals industry.  
Encodes up to five different numbers, each with its own color which may be entered in decimal or “binary” format with a 1 represented by a thick bar and a 0 represented by a thin bar. Bar width is independent of height.
- Definition:**  
In decimal format, each part can be up to 999999.  
In binary format, each input have up to 19 ones and zeros.
- Serial Cmd:** **<K477,status,fixed symbol length status,fixed symbol length,min. no. of bars,bar width status,direction,fixed threshold value>**
- Default:** **Disabled**
- Options:** 0 = Disabled      1 = Enabled

## Fixed Symbol Length Status (Pharmacode)

- Definition:** When enabled, the reader will check the symbol length against the symbol length field. If disabled, any length would be considered a valid symbol.
- Serial Cmd:** **<K477,status,fixed symbol length status,fixed symbol length,min. no. of bars,bar width status,direction,fixed threshold value>**
- Default:** **Disabled**
- Options:** 0 = Disabled      1 = Enabled

## Fixed Symbol Length (Pharmacode)

- Definition:** This specifies the exact number of characters that the reader will recognize (this does not include start and stop and check digit characters). The reader ignores any symbology not having the specified length.
- Serial Cmd:** **<K477,status,fixed symbol length status,fixed symbol length,min. no. of bars,bar width status,direction,fixed threshold value>**
- Default:** **10**
- Options:** 4 to 16

## Minimum Number of Bars (Pharmacode)

- Definition:** Sets the minimum number of bars that a pharmacode symbol must have to be considered as a valid symbol.
- Serial Cmd:** **<K477,status,fixed symbol length status,fixed symbol length,min. no. of bars,bar width status,direction,fixed threshold value>**
- Default:** **4**
- Options:** 4 to 16



## Bar Width Status (Pharmacode)

- Definition:** If set to **Mixed**, it will autodiscriminate between narrow bars and wide bars. If set to **All Narrow**, all bars will be considered as narrow bars. If set to **All Wide**, all bars will be considered as wide bars. If set to **Fixed Threshold**, it will use the **Fixed Threshold** value to determine whether the bars are narrow or wide. The **Bar Width Status** setting will be ignored when the reader is able to tell the difference between the narrow and the wide bars.
- Serial Cmd:** *<K477,status,fixed symbol length status,fixed symbol length,min. no. of bars, **bar width status**,direction,fixed threshold value>*
- Default:** **Mixed**
- Options:** 0 = Mixed                      1 = All Narrow  
2 = All Wide                         3 = Fixed Threshold

## Direction (Pharmacode)

- Definition:** Specifies the direction that a symbol can be read.
- Serial Cmd:** *<K477,status,fixed symbol length status,fixed symbol length,min. no. of bars, bar width status,**direction**,fixed threshold value>*
- Default:** **Forward**
- Options:** 0 = Forward                      1 = Reverse

## Fixed Threshold Value (Pharmacode)

- Definition:** Used when **Bar Width Status** is set to **Fixed Threshold**. Defines the minimum difference in pixels that will distinguish a narrow bar from a wide bar.
- Serial Cmd:** *<K477,status,fixed symbol length status,fixed symbol length,**min. no. of bars**,bar width status,direction,fixed threshold value>*
- Default:** **10**
- Options:** 1 to 65535

## RSS Expanded

- Usage:* Used to encode primary and supplementary data in retail point-of-sale and other applications.
- Definition:* RSS Expanded is a variable length symbology that can encode supplementary information in addition to the 14-digit EAN.UCC item identification number and is capable of encoding up to 74 numeric or 41 alphabetic characters.
- Serial Cmd:* **<K484, status, fixed symbol length status, fixed symbol length>**
- Default:* **Disabled**  
0 = Disabled
- Options:* 1 = Enabled (non-stacked)  
2 = Enabled (stacked and non-stacked)

Where appropriate, use 1 (non-stacked) for better performance over 2 (stacked and non-stacked).

### Fixed Symbol Length Status (RSS Expanded)

- Definition:* When enabled, the reader will check the symbol length against the symbol length field, minus the embedded check digit. If disabled, any length would be considered a valid symbol.
- Serial Cmd:* **<K484, status, fixed symbol length status, fixed symbol length>**
- Default:* **Disabled**
- Options:* 0 = Disabled      1 = Enabled

### Fixed Symbol Length (RSS Expanded)

- Usage:* **Fixed Symbol Length** helps prevent truncations and increases data integrity by ensuring that only one symbol length will be accepted.
- Definition:* Specifies the exact number of characters that the reader will recognize (this does not include start and stop and check digit characters). The reader ignores any symbol not having the specified length.
- Serial Cmd:* **<K484, status, fixed symbol length status, fixed symbol length>**
- Default:* **10**
- Options:* 1 to 74

## RSS Limited

- Usage:* RSS Limited is designed to be read by laser and CCD readers. It is not recommended for omnidirectional slot scanners.
- Definition:* Encodes a smaller 14-digit symbol (74 modules wide) that is not omnidirectional.
- Serial Cmd:* <**K483, status**>
- Default:* **Disabled**
- Options:* 0 = Disabled  
1 = Enabled

## RSS-14

*Usage:* Used in the grocery retail and prescription drug industries where full 14-digit EAN.UCC item identification may be needed.

*Definition:* RSS-14 (Reduced Space Symbology) is a fixed length symbology that encodes 14-digits, including a 1 digit indicator digit and is 96 modules wide. It can be stacked into two rows, read omnidirectional if printed in full height, or not if height-truncated for small marking.

*Serial Cmd:* <**K482, status**>

*Default:* **Disabled**

0 = Disabled

*Options:* 1 = Enabled (non-stacked)

2 = Enabled (stacked and non-stacked)

Where appropriate, use 1 (non-stacked) for better performance over 2 (stacked and non-stacked).

# PDF417

**Usage:** Used in applications where a large amount of information (over 32 characters) needs to be encoded within a symbol, typically where the symbol is transported from one facility to another. For example, an automobile assembly line might use a single symbol with multiple fields of information that will be read at several stations along the way, without reference to a database.

**Definition:** A two-dimensional, multi-row (3 to 90), continuous, variable length symbology that has high data capacity for storing up to 2700 numeric characters, 1800 printable ASCII characters, or 1100 binary character per symbol. Each symbol character consists of 4 bars and 4 spaces in a 17-module structure.

**Serial Cmd:** `<K476,status,[unused],fixed symbol length status,fixed symbol length,[unused],codeword collection>`

**Default:** **Disabled**

**Options:** 0 = Disabled      1 = Enabled

**Note:** Sending `<a1>` will cause PDF417 data to be prefaced with information consisting of error correction level (ECC Level *n*), number of rows (*n* Rows), number of columns (*n* Columns), number of informative code words (*n* Info Code Words) and the number of data characters (*n* Data Bytes). This feature can be disabled by re-sending `<a1>`.

## Fixed Symbol Length Status (PDF417)

**Serial Cmd:** `<K476,status,[unused],fixed symbol length status,fixed symbol length,[unused],codeword collection>`

**Default:** **Disabled**

**Options:** 0 = Disabled      1 = Enabled

## Fixed Symbol Length (PDF417)

**Usage:** Used to increase data integrity by ensuring that only one symbol length will be accepted.

**Definition:** When enabled, the PDF symbol must contain the same number of characters as the symbol length setting before it can be considered a good read. The reader will ignore any symbol not having the specified length.

**Serial Cmd:** `<K476,status,[unused],fixed symbol length status,fixed symbol length,[unused],codeword collection>`

**Default:** **10**

**Options:** 1 to 2710

**Note:** **Fixed Symbol Length Status** must be enabled for **Fixed Symbol Length** to take effect.

## Codeword Collection (PDF417)

**Usage:** **Multiple Codeword Collection** is useful in applications where portions of subsequent images can be read and pieced together so that no opportunity or time is lost to assemble codewords for decoding.

**Definition:** When set to **Multiple**, PDF codewords is collected from multiple images and assembled throughout the read cycle until the read cycle ends or the symbol is fully decoded. It is important to note that when this feature is enabled, only one PDF symbol should be presented to the reader per read cycle.

**Serial Cmd:** `<K476,status,[unused],fixed symbol length status,fixed symbol length,[unused],codeword collection>`

**Default:** **Single Image**

**Options:** 0 = Single Image 1 = Multiple Image

**Note:** **Fixed Symbol Length Status** must be enabled for **Fixed Symbol Length** to take effect.

# MicroPDF417

- Usage:** Used for labeling small items that need large capacity.
- Definition:** A variant of PDF417, a very efficient and compact stacked symbology that can encode up to 250 alphanumeric characters or 366 numeric characters per symbol.
- Serial Cmd:** <**K485**,status,[unused],fixed symbol length status,fixed symbol length>
- Default:** **Disabled**
- Options:** 0 = Disabled      1 = Enabled

## Fixed Symbol Length Status (MicroPDF417)

- Serial Cmd:** <**K485**,status,[unused],fixed symbol length status,fixed symbol length>
- Default:** **Disabled**
- Options:** 0 = Disabled      1 = Enabled

## Fixed Symbol Length (MicroPDF417)

- Usage:** Used to increase data integrity by ensuring that only one symbol length will be accepted.
- Definition:** When enabled, the Micro PDF symbol must contain the same number of characters as the symbol length setting before it can be considered a good read. The reader will ignore any symbol not having the specified length.
- Serial Cmd:** <**K485**,status,[unused],fixed symbol length status,fixed symbol length>
- Default:** **10**
- Options:** 1 to 2710
- Note:** **Fixed Symbol Length Status** must be enabled for **Fixed Symbol Length** to take effect.

## Composite

When set to **Enabled** or **Required**, will attempt to decode the composite component of a linear symbol. The linear symbol can be RSS14, RSS Expanded, RSS Limited, UCC/EAN-128, UPC-A, EAN-13, EAN-8, and UPC-E.

*Usage:* Allows reading by both linear and 2D readers.

*Definition:* Combines 2D and linear width modulated symbology on the same symbol where different messages can be read by each reader type.

*Serial Cmd:* <**K453**,*mode*,*separator status*,*separator*>

*Default:* **Disabled**

*Options:* 0 = Disabled          1 = Enabled          Required

### **Enabled**

If set to **Enabled** it only decodes the linear component, it will output only the linear component.

### **Required**

If set to **Required**, it must decode both the linear and the composite components; otherwise it outputs a noread.

## **Separator Status (Composite)**

*Usage:* Allows user to distinguish between the main and **Supplemental** symbols.

*Definition:* This separator separates the linear symbol and the composite component.

*Serial Cmd:* <**K453**,*mode*,**separator status**,*separator*>

*Default:* **Disabled**

*Options:* 0 = Disabled          1 = Enabled

## **Separator Character (Composite)**

**Note:** If **Separator Character** has been changed to any other character and you wish to re-define the separator as a comma, you will need to use **ESP** or the embedded menu.

*Usage:* As required by the application.

*Definition:* Allows the user to change the separator character from a comma to a new character.

*Serial Cmd:* <**K453**,*mode*,*separator status*,**separator**>

*Default:* , (**comma**)

*Options:* Any ASCII character



---

## Narrow Margins

**Note:** **Narrow Margins** is only used for linear symbology types. Do not use with PDF.

*Usage:* Used when the leading and trailing edges of the symbols are smaller than the standard margin or other objects encroach into the margins.

*Definition:* Allows the reader to read symbols with quiet zones less than 8 times the width of the narrow bar element. "Quiet zone" is the space at the leading and trailing ends of a symbol. Each quiet zone can be as narrow as only five times the width of the narrow bar element when **Narrow Margins** is enabled.

*Serial Cmd:* <**K450, narrow margins**,symbology identifier status>

*Default:* **Disabled**

*Options:* 0 = Disabled      1 = Enabled

**Note:** Do not use **Narrow Margins** with **Large Intercharacter Gap** enabled in Code 39.

# Symbology ID

**Usage:** Used when the symbology type and how it's decoded needs to be known. Symbology ID is an ISO/IEC 16022 standard prefix set of characters that identifies the symbol type. When enabled, the reader analyzes and identifies the symbology and adds a three character identifying prefix to the data:

- Definition:**
1. **]** (close bracket character) indicating the presence of a symbology ID
  2. **A, C, E, I, L, Q, b, d, p**  
 A = Code 39; C = Code 128; E = UPC/EAN; I = I-2/5; L = PDF417; Q = QR Code; b = BC412; d = Data Matrix; p = Pharmacode
  3. **Modifier**

**Serial Cmd:** <**K450**, narrow margins, **symbology identifier status**>

**Default:** **Disabled**

**Options:** 0 = Disabled      1 = Enabled

## Explanation of Modifiers for Code 39, Codabar, and I-2/5

- For Code 39, Codabar and I 2/5, the modifier indicates **Check Digit** and **Check Digit Output** status.
- For Code 39 only, **Full ASCII** needs to be enabled to see modifiers **4, 5, and 7**.

Modifier	Check Digit	Check Digit Output	Full ASCII conversion performed (Code 39 only)
<b>0</b>	Disabled	N/A	No
<b>1</b>	Enabled	Enabled	No
<b>3</b>	Enabled	Disabled	No
<b>4</b>	Disabled	N/A	Yes
<b>5</b>	Enabled	Enabled	Yes
<b>7</b>	Enabled	Disabled	Yes

**Example:** **JA5** indicates a Code 39 symbol with **Check Digit** and **Check Digit Output** enabled and Full ASCII conversion performed.

## Explanation of Modifiers for Other Symbologies

- For Code 128, a **1** indicates ECC/EAN-128; otherwise the modifier is a **0**.
- For QR Code, a **0** indicates Model 1; a **1** indicates Model 2.
- For all other codes, the modifier is **0**.

# Background Color

- Usage:* If the background is darker than the symbol, then enable black background. Typically the background is white; but on PCBs for example, they can be black.
- Definition:* Allows the user to choose which symbol background (white or black) the reader can read.
- Serial Cmd:* **<K451, background color>**
- Default:* **White**
- Options:* 0 = White                      1 = Black



# 5 I/O Parameters

## Contents

I/O Parameters by ESP .....	5-2
I/O Parameters Serial Commands .....	5-3
Symbol Data Output .....	5-4
When to Output Symbol Data .....	5-6
Noread Message .....	5-7
Bad/No Symbol Qualification .....	5-10
Read Duration Output .....	5-18
Output Indicators .....	5-19
Serial Verification .....	5-23
Video Output .....	5-25
Image Output .....	5-28
Image Captioning .....	5-30
Synchronous Trigger .....	5-32
EZ Button .....	5-34
Input 1 .....	5-38
Output 1 Parameters .....	5-39
Output 2 Parameters .....	5-52
Output 3 Parameters .....	5-54

This section includes instructions on setting up conditions for changing input/output electrical transitions for control of internal and external devices. A discrete I/O (in/out) signal is an electrical transition from one voltage level to another so that digital switching can occur.

**Note:** The characters **NULL <>** and **,** can only be entered through embedded menus, not through **ESP** or serial commands.

# I/O Parameters by ESP

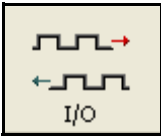

Click this button to bring up the **I/O** menu.

To open nested options, **single-click** the +.

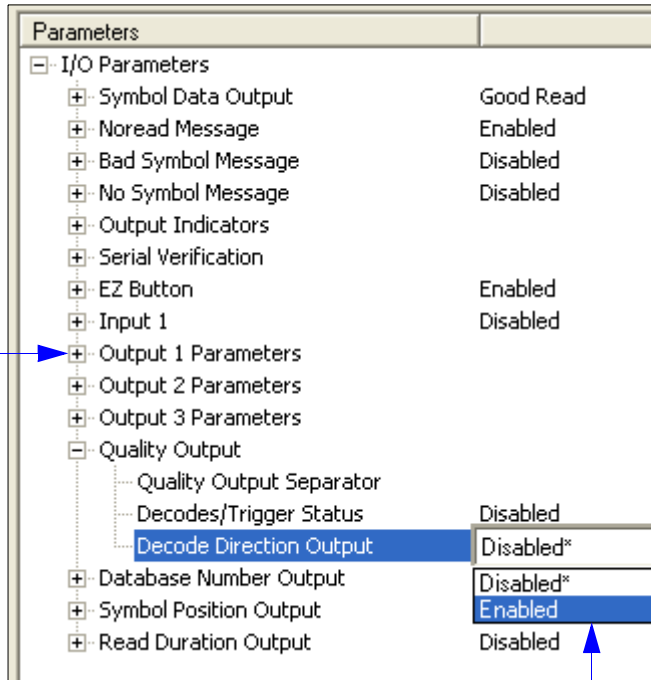

Parameters	
[-] I/O Parameters	
+ Symbol Data Output	Good Read
+ Noread Message	Enabled
+ Bad Symbol Message	Disabled
+ No Symbol Message	Disabled
+ Output Indicators	
+ Serial Verification	
+ EZ Button	Enabled
+ Input 1	Disabled
+ Output 1 Parameters	
+ Output 2 Parameters	
+ Output 3 Parameters	
[-] Quality Output	
Quality Output Separator	
Decodes/Trigger Status	Disabled
Decode Direction Output	Disabled*
+ Database Number Output	Disabled*
+ Symbol Position Output	Enabled
+ Read Duration Output	Disabled

To change a setting, **double-click** the setting and use your cursor to scroll through the options.

# I/O Parameters Serial Commands

Symbol Data Output	<K705,symbol data output status,when to output>
Noread Message	<K714,noread message status,noread message>
Bad Symbol Message	<K715,[unused],message>
No Symbol Message	<K716,[unused],message>
1D/Stacked Symbology Qualification	<K717,minimum number of bars,minimum number of qualified scans,start/stop status>
2D Symbology Qualification	<K718,finder pattern status,symbol size mode,symbol size 1,symbol size 2,symbol size tolerance,dimension mode,dimension 1,dimension 2,dimension tolerance,orientation mode,orientation value>
Read Duration Output	<K706,status,separator>
LED Indicators	<K750,green flash mode,x-pattern status,green flash duration>
Beeper	<K702,beeper status>
LED Configuration	<K737,LED mode,ISO/IEC 15415 grade,DPM grade>
Serial Verification	<K701,serial command echo status,serial command beep status,control/hex output>
Video Output	<K760,video output mode,trigger image mode,image frame>
Image Output	<K739,image output mode,comm port,file format,JPEQ quality>
Image Captioning	<K762,mode>
Synchronous Trigger	<K761,synchronous trigger mode>
EZ Button	<K770,global status,default on power-on,load IP database,save for power-on>
EZ Button Modes	<K771,position 1 mode,position 2 mode,position 3 mode,position 4 mode>
Input 1	<K730,input mode,active state>
Output 1 Parameters	<K810,output on,active state,pulse width,output mode>
Trend Analysis Output 1	<K780,trend analysis mode,number of triggers,number to output on>
Symbol Quality (ISO/IEC 15415) to Output 1	<K800,output on symbol contrast,symbol contrast threshold,output on print growth,print growth threshold,output on axial non-uniformity,axial non-uniformity threshold,output on unused ecc,unused ecc threshold>
Symbol Quality (Inkjet/Direct) to Output 1	<K820,output on dot center offset,dot center offset,output on cell fill,cell fill,output on dot ovality,dot ovality threshold,output on angle of distortion,angle of distortion threshold>
Diagnostic Warnings to Output 1	<K790,over temp,service unit,external camera disconnect>
Output 2	<K811,output on,active state,pulse width,output mode>
Trend Analysis Output 2	<K781,trend analysis mode,trigger evaluation period,number to output on>
Symbol Quality (ISO/IEC 15415) to Output 2	<K801,output on symbol contrast,symbol contrast threshold,output on print growth,print growth threshold,output on axial non-uniformity,axial non-uniformity threshold,output on unused ecc,unused ecc threshold>
Symbol Quality (Inkjet/Direct) to Output 2	<K821,output on dot center offset,dot center offset,output on cell fill,cell fill,output on dot ovality,dot ovality threshold,output on angle of distortion,angle of distortion threshold>
Diagnostic Warnings to Output 2	<K791,over temp,service unit,external camera disconnect>
Output 3	<K812,output on,active state,pulse width,output mode>
Trend Analysis Output 3	<K782,trend analysis mode,trigger evaluation period,number to output on>
Symbol Quality (ISO/IEC 15415) to Output 3	<K802,output on symbol contrast,symbol contrast threshold,output on print growth,print growth threshold,output on axial non-uniformity,axial non-uniformity threshold,output on unused ecc,unused ecc threshold>
Symbol Quality (Inkjet/Direct) to Output 3	<K822,output on dot center offset,dot center offset,output on cell fill,cell fill,output on dot ovality,dot ovality threshold,output on angle of distortion,angle of distortion threshold>
Diagnostic Warnings to Output 3	<K792,over temp,service unit,external camera disconnect>





## **Good Read**

*Usage:* **Good Read** is used when an application requires all symbol data to be transmitted. It's typically used in tracking applications in which each object is uniquely identified.

*Definition:* With **Good Read** enabled, the reader transmits symbol data on any good read regardless of **Matchcode Type** setting.

**Note:** A noread can still be transmitted if enabled.

# When to Output Symbol Data

*Definition:* This command allows the user to choose when symbol data can be sent to the host.

*Serial Cmd:* <**K705**,symbol data output status,**when to output**>

*Default:* **As Soon As Possible**

*Options:* 0 = As Soon As Possible                      1 = End of Read Cycle

## **As Soon As Possible**

*Usage:* **As Soon As Possible** is useful in applications in which symbol data needs to be moved quickly to the host, typically when the host is making decisions based on symbol data.

*Definition:* Enabling **As Soon As Possible** causes symbol data to be sent to the host immediately after a symbol has been successfully decoded.

**Note:** More than one decode might in fact be required to qualify as a good read, depending on how **Decodes Before Output** is set.

## **End of Read Cycle**

*Usage:* **End of Read Cycle** is useful in timing-based systems in which the host is not ready to accept data at the time it is decoded.

Enabling **End of Read Cycle** means that symbol data does not get sent to the host until the read cycle ends with a timeout or new trigger.

*Definition:*

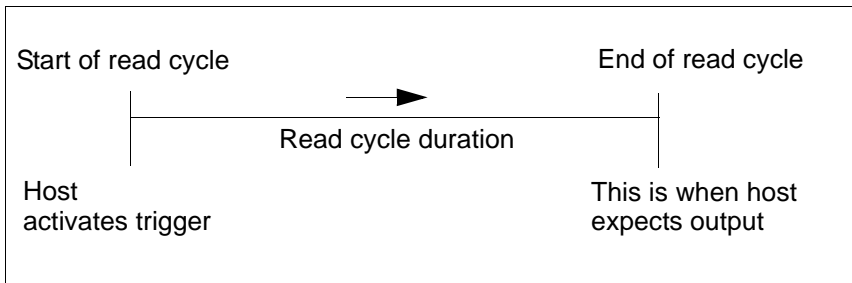

*Read Cycle*

## Noread Message

*Usage:* Used in applications where the host needs serial verification that a symbol has not been read and especially useful in new print verification.

*Definition:* When enabled, and if no symbol has been decoded before timeout or the end of the read cycle, the noread message will be transmitted to the host.

### Noread Message Mode

*Serial Cmd:* <**K714, noread message status, noread message**>

*Default:* **Enabled**

*Options:* 0 = Disabled      1 = Enabled      2 = Detailed Noread Message

#### **Disabled**

No message is output when a noread condition occurs.

#### **Enabled**

The user-defined noread message is output whenever a noread condition occurs.

#### **Detailed Noread Message**

**Important:** In the case where the conditions set in **Bad/No Symbol Qualification** are met, then the **Bad Symbol** or **No Symbol** message output will override the **Noread Message** or the **Detailed Noread Message**, if either is enabled.

*Usage:* Use this option to cover more detailed reasons for decode failures.

*Definition:* Outputs a **Noread** message followed by an additional message (an Image Processing Results Code) indicating the reason a symbol failed to decode.

For example, in the following output: "NOREAD d\_1, E\_2" d and E are symbology ids for Datamatrix and UPC respectively. The message means that Datamatrix and UPC are enabled (and other symbologies are not), and that both failed to decode. The reason for the failing Datamatrix is 1 and the reason for the failing UPC is 2. The first part of these numbers (preceding the dot) is the relevant number and interpreted here:

#### **2D Symbologies:**

1. Failed to locate symbol (no finder pattern).
2. Failed to locate four corners or failed to qualify user-defined dimension (in pixels).
3. Failed to locate clocks or failed to qualify user-defined orientation (0-359 degree).
4. Failed to validate clocks or failed to qualify user-defined symbol size (clock element count).
5. Failed to decode symbol.

***Linear Symbologies:***

1. Failed user-defined minimum number of bars.
2. Failed to decode start/stop character (doesn't apply to UPC, RSS, MicropPDF417 and Pharmacode).
3. Failed user-defined minimum number of scan lines that qualify for the minimum number of bars.
4. Failed to decode.
5. Failed to decode UPC supplemental.

## **Noread Message**

*Definition:* Any combination of ASCII characters can be defined as the noread message.

*Serial Cmd:* <**K714**, noread message status, **noread message**>

*Default:* **NOREAD**

*Options:* 0 to 128 ASCII characters.

**Note: Noread Message** will only be transmitted if **Symbol Data Output** is set to **Match**, **Mismatch** or **Good Read**.

**Noread Message** can be set to any ASCII characters except **NULL** < , or >.

## Bad/No Symbol Qualification

- Usage:* Useful in determining if a symbol is present and if user-defined requirements for that symbol are met.
- Definition:* Sets the requirements that will qualify an object or a symbol before outputting a decode or message.

### Bad Symbol Message

- Usage:* Can tell the user if a qualified symbol is present but not decodable.
- Definition:* When enabled, sends a message to the host whenever an object meets specified qualifications for “bad symbol” status.
- Serial Cmd:* <**K715**,[unused],**message**>
- Default:* **BAD\_SYMBOL**
- Options:* Up to 128 ASCII characters (except **NULL**)

### No Symbol Message

- Usage:* Can tell the user if a object does not qualify as a symbol.
- Definition:* When enabled, send a message to the host whenever an object meets specified qualifications for “no symbol” status but is not decoded.
- Serial Cmd:* <**K716**,[unused],**message**>
- Default:* **NO\_SYMBOL**
- Options:* Up to 128 ASCII characters (except **NULL**)

## 1D/Stacked Symbology Qualification

### Minimum Number of Bars

- Definition:* Sets the minimum number of bars to qualify linear symbols.
- Serial Cmd:* <**K717**,**minimum number of bars**,*minimum number of qualified scans,start/stop status*>
- Default:* **0**
- Options:* 0 to 255 (0 is disabled)

## Minimum Number of Qualified Scan Lines

*Definition:* Sets the minimum number of scans that have the required number of bars set in **Minimum Number of Bars**.

*Serial Cmd:* <**K717**,*minimum number of bars*,**minimum number of qualified scans**,*start and stop status*>

*Default:* **0**

*Options:* 0 to 11 (0 is disabled)

## Start/Stop Status

*Definition:* When enabled, both **Start** and **Stop** characters need to be present to qualify as a decodable symbol. In the case of PDF417, only a **Stop or Stop** needs to be present.

**Note:** This parameter does not apply to UPC, Pharmacode, RSS and Micro PDF417.

*Serial Cmd:* <**K717**,*minimum number of bars*,*minimum number of qualified scans*,**start and stop status**>

*Default:* **Disabled**

*Options:* 0 = Disabled      1 = Enabled

## 2D Symbology Qualification

**Note:** in the cases where **Symbol Size Status**, **Dimension Status**, or **Orientation Status** is enabled, the reader will always check the finder pattern regardless of **Finder Pattern Status** setting.

### Finder Pattern Status

*Definition:* Checks for the presence of finder pattern.

*Serial Cmd:* <K718,finder pattern status,symbol size mode,symbol size 1,symbol size 2,symbol size tolerance,dimension mode,dimension 1,dimension 2,dimension tolerance,orientation mode,orientation value>

*Default:* **Disabled**

*Options:* 0 = Disabled 1 = Enabled

### Symbol Size Mode (2D Symbology Qualification)

**Note:** if **Symbol Size 1** is larger than **Symbol Size 2**, it will be automatically reversed in the algorithm.

*Definition:* Specifies the outputs resulting from the results of searches for **Symbol Size 1** and **Symbol Size 2**.

*Serial Cmd:* <K718,finder pattern status,symbol size mode,symbol size 1,symbol size 2,symbol size tolerance,dimension mode,dimension 1,dimension 2,dimension tolerance,orientation mode,orientation value>

*Default:* **Disabled**

0 = Disabled

*Options:* 1 = Bad/No Symbol Output

2 = Object Qualification

3 = Enable Both

#### **Disabled**

Decoded messages are output, but no attempt to qualify symbols or output **Bad** or **No Symbol** messages is undertaken.

#### **Bad/No Symbol Output**

Checks first for decodes. If no symbol is decoded, checks for symbol size. If both **Symbol Size 1** and **Symbol Size 2** requirement are met, a **Bad Symbol** message is output. If both are not met, outputs a **No Symbol** message.

#### **Object Qualification**

Checks first for matches to symbol size. If qualified, attempts to decode. If no decodes are found within the specified read cycle parameters, outputs a **Noread** message.

#### **Enable Both**

Same as **Object Qualification**, except that if no objects qualify, then a **No Symbol** message is output; if at least one object qualifies, then a **Bad Symbol** message is output.



## Symbol Size 1 (2D Symbology Qualification)

*Definition:* Checks for symbol sizes for a specified number of elements. In the case of rectangular symbols, checks the longer side.

*Serial Cmd:* <**K718**,finder pattern status,symbol size status,**symbol size 1**,symbol size 2,symbol size tolerance,dimension mode,dimension 1,dimension 2,dimension tolerance,orientation mode,orientation value>

*Default:* **10**

*Options:* 8 to 88 elements

## Symbol Size 2 (2D Symbology Qualification)

*Definition:* Checks for symbol sizes for a specified number of elements. In the case of rectangular symbols, checks the shorter side.

*Serial Cmd:* <**K718**,finder pattern status,symbol size status,symbol size 1,**symbol size 2**,symbol size tolerance,dimension mode,dimension 1,dimension 2,dimension tolerance,orientation mode,orientation value>

*Default:* **10**

*Options:* 8 to 88 elements

## Symbol Size Tolerance (2D Symbology Qualification)

*Definition:* Sets the allowable deviation, up or down, for symbol sizes specified in **Symbol Size 1** and **Symbol Size 2**.

*Serial Cmd:* <**K718**,finder pattern status,symbol size status,symbol size 1,symbol size 2,**symbol size tolerance**,dimension mode,dimension 1,dimension 2,dimension tolerance,orientation mode,orientation value>

*Default:* **2**

*Options:* 0 to 10

## Dimension Mode (2D Symbology Qualification)

- Definition:** Enables the searches for symbol **Dimension 1** and **Dimension 2**.  
<**K718**,finder pattern status,symbol size status,symbol size 1,symbol size 2,symbol size tolerance,**dimension mode**,dimension 1,dimension 2,dimension tolerance,orientation mode,orientation value>
- Default:** **Disabled**  
0 = Disabled
- Options:** 1 = Bad/no symbol output  
2 = Object qualification  
3 = Enable both

### **Disabled**

Decoded messages are output, but no attempt to qualify symbols or output **Bad** or **No Symbol** messages is undertaken.

### **Bad/No Symbol Output**

Checks first for decodes. If no symbol is decoded, checks for symbol dimension. If both **Dimension 1** and **Dimension 2** requirements are met, a **Bad Symbol** message is output. If both are not met, outputs a **No Symbol** message.

### **Object Qualification**

Checks first for matches to symbol dimension. If qualified, attempts to decode. If no decodes are found within the specified read cycle parameters, outputs a **Noread** message.

### **Enable Both**

Same as **Object Qualification**, except that if neither **Dimension 1** nor **Dimension 2** qualifies, then a **No Symbol** message is output; if either **Dimension 1** or **Dimension 2** qualifies, then a **Bad Symbol** message is output.

## Dimension 1 (2D Symbology Qualification)

- Definition:** Checks symbol dimension for a specified number of pixels. In the case of rectangular symbols, checks the longer side.
- Serial Cmd:** <**K718**,finder pattern status,symbol size status,symbol size 1,symbol size 2,symbol size tolerance,dimension mode,**dimension 1**,dimension 2,dimension tolerance,orientation mode,orientation value>
- Default:** **0**
- Options:** 0 to 656 pixels

## Dimension 2 (2D Symbology Qualification)

*Definition:* Checks symbol dimension for a specified number of pixels. In the case of rectangular symbols, checks the shorter side.

*Serial Cmd:* <**K718**,finder pattern status,symbol size status,symbol size 1,symbol size 2,symbol size tolerance,dimension mode,dimension 1,**dimension 2**,dimension tolerance,orientation mode,orientation value>

*Default:* **0**

*Options:* 0 to 656 pixels

## Dimension Tolerance (2D Symbology Qualification)

*Definition:* Sets the allowable deviation, in percentage, for symbol sizes specified in **Dimension 1** or **Dimension 1**.

*Serial Cmd:* <**K718**,finder pattern status,symbol size status,symbol size 1,symbol size 2,symbol size tolerance,dimension mode,dimension 1,dimension 2,**dimension tolerance**,orientation mode,orientation value>

*Default:* **10**

*Options:* 0 to 100

## **Orientation Mode (2D Symbology Qualification)**

*Definition:* Sets the orientation value.

*Serial Cmd:* <**K718**,finder pattern status,symbol size status,symbol size 1,symbol size 2,symbol size tolerance,dimension mode,dimension 1,dimension 2,dimension tolerance,**orientation mode**,orientation value>

*Default:* **Disabled**

0 = Disabled

*Options:* 1 = Bad/no symbol output

2 = Object qualification

3 = Enable both

### ***Disabled***

Decoded messages are output, but no attempt to qualify symbols or output **Bad** or **No Symbol** messages is undertaken.

### ***Bad/No Symbol Output***

Checks first for decodes. If no symbol is decoded, checks for symbol orientation. If **Orientation Value** is satisfied, a **Bad Symbol** message is output. If not satisfied, outputs a **No Symbol** message.

### ***Object Qualification***

Checks first for matches to symbol **Orientation Value**. If qualified, attempts to decode. If no decodes are found within the specified read cycle parameters, outputs a **Noread** message.

### ***Enable Both***

Same as **Object Qualification**, except that if **Orientation Value** is satisfied but the symbol is not decoded, then a **Bad Symbol** message is output; if **not** satisfied, outputs a **Bad Symbol** message.

## Orientation Value

**Usage:** Instructs the reader to ignore symbols not in the specified orientation.  
Sets the orientation of the symbol, in degrees clockwise from the default 0 orientation.

For Data Matrix symbols, sets the finder "L" pattern, with the adjacent being an example of the default 0 orientation:



**Definition:** For QR Code, sets the locator pattern (three squares), with the adjacent being an example of the default 0 orientation:



The other position settings will rotate clockwise from the defaults shown above.

**Serial Cmd:** <**K718**,finder pattern status,symbol size status,symbol size 1,symbol size 2,symbol size tolerance,dimension mode,dimension 1,dimension 2,dimension tolerance,orientation mode,**orientation value**>

**Default:** 0

**Options:** 0 to 359

**Note:** A symbol's orientation can miss the precise **Orientation Value** by several degrees and still be qualified. To be certain of the extent of the allowable tolerance, you should experiment with symbols in various orientations. In no case can they be more than **45°** from the assigned orientation value and still be qualified.

## Read Duration Output

*Usage:* Useful in evaluating actual read cycle timing results, especially when initially setting up an application to determine maximum line speed that can be obtained based on the spacing between symbols.

*Definition:* When enabled, the duration of the read cycle (in milliseconds) is appended to the symbol data.  
The read duration is the time from the beginning of the read cycle until data is output.

### Read Duration Output Mode

*Serial Cmd:* <K706, **status**, separator>

*Default:* **Disabled**

*Options:* 0 = Disabled  
1 = Enabled

**Important:** To measure the entire read cycle when in **External Level** trigger mode, set **When to Output Symbol Data** to **End of Read Cycle**.

This output can measure over 49 days worth of duration; if exceeded, the "OVERFLOW" message will be output in place of the duration.

*Options:* 0 = Disabled 1 = Enabled

### Read Duration Output Separator

*Definition:* User-defined character that separates the symbol information from the **Read Duration Output**.

*Serial Cmd:* <K706, status, **separator**>

*Default:* **[space character]**

*Options:* Any ASCII character

# Output Indicators

The Quadrus EZ has a beeper and three LED arrays, as follows:

1. An **X**-pattern of blue LEDs in the front of the reader that project an **X**-shape for centering the field of view.
2. An array of green LEDs in the front of the reader that can be programmed to flash in response to user-defined conditions.
3. A row of five status LEDs on the side of the Quadrus EZ.

## **X**-Pattern

**Usage:** Assists users in positioning and locating symbols in the center of the reader's FOV.

**Definition:** The user can control when the targeting system is ON or OFF and save this condition for power-on.

**Serial Cmd:** <**K750**,green flash mode,**x-pattern status**,green flash duration>

**Default:** **Always Off**

0 = Always OFF

1 = ON when NOT in the read cycle

**Options:**

2 = ON when in the read cycle

3 = Always ON

**Important:** The targeting system actuated by the EZ button or operational command overrides this setting.

### **Always OFF**

The **X**-pattern will remain OFF at all times unless overridden by the EZ button or operational command.

### **On When NOT In The Read Cycle**

The **X**-pattern is always ON except during the read cycle. If the EZ button or operational command overrides this setting, the **X**-pattern will remain on at all times.

### **On When in the Read Cycle**

The **X**-pattern will remain OFF except during the read cycle. If the EZ button or operational command overrides this setting, the **X**-pattern will remain on at all times.

### **Always ON**

The **X**-pattern is always ON.

## Green Flash Mode

**Usage:** Used as a visual verification that a good read has occurred.

**Definition:** An array of green LEDs in the front of the Quadrus EZ can be programmed to flash briefly in response to user-defined conditions, or if in **Static Presentation** mode, illuminate for a set period of time.

**Serial Cmd:** `<K750,green flash mode,x-pattern status,green flash duration>`

**Default:** **Good Read**

0 = Disabled

1 = Good Read

**Options:** 2 = Static Presentation

3 = Match

4 = Mismatch

### Disabled

Green flash LEDs are disabled.

### Good Read (Green Flash)

Green flash LEDs will flash for less than one second when a good read condition is met or when matchcode is enabled and a match occurs.

### Static Presentation (Green Flash)

Static Presentation is used in conjunction with **Continuous Read** mode.

When operating in **Static Presentation** mode, the LEDs will illuminate while the Quadrus EZ is searching for a symbol in **Continuous Read** mode. When a symbol is placed in the FOV and a good read occurs, the green LEDs will illuminate and stay on for the duration of time set in **Green Flash Duration**. Only one read will occur during that time unless more than one symbol is enabled in **Number of Symbols**.

**Note:** If **Static Presentation** mode is selected but the reader is not in **Continuous Read**, the **Green Flash** will revert to **Good Read** mode.

To use Static Presentation:

1. Enable **Continuous Read**.
2. Select the number of symbols.
3. Enable **Static Presentation** in **Green Flash Mode**.
4. Select the read time in **Green Flash Duration**.

**Note:** Green Flash Duration values only take effect in Static Presentation Mode.

### Match (Green Flash)

Green flash LEDs will flash for less than 1 second when a match condition is met. If multi-symbol is enabled, then green flash LEDs will illuminate only if all symbols qualify as a match. If matchcode is disabled, then this mode will activate the LED's on a good read.

### Mismatch (Green Flash)

Same as **On Match** except it illuminates on a mismatch.



## Green Flash Duration

- Usage:** A visual verification that a good read has occurred.
- Definition:** When a good read occurs, the Green flash LED's will illuminate and stay on for the time set for the **Green Flash Duration** value.
- Serial Cmd:** **<K750,green flash mode,x-pattern status,green flash duration>**
- Default:** **100** (1 second)
- Options:** 0 to 65535 (in 10mS increments)
- Note:** Green Flash Duration values only take effect in Static Presentation Mode.

## Beeper

- Usage:** An audible verification that either a good read or a noread has occurred.
- Definition:** A beep is emitted either after each good read or noread.
- Serial Cmd:** **<K702,beeper status>**
- Default:** **Good Read**
- 0 = Disabled
- Options:** 1 = Good Read  
2 = Noread

**Note:** Beeper will also sound if any of the following occur:

- the reader is defaulted
- a send/save command from **ESP** or an **Exit** command from any embedded menu
- at the conclusion of a calibrate procedure
- a **<Z>**, **<Zp>**, **<Zd>**, or **<K701,1>** command is sent

## LED Configuration Mode

- Usage:** Useful as a visible verification of read rates and bar code quality.
- Definition:** Determines the mode in which the status LEDs on the side of the Quadrus EZ operate.
- Serial Cmd:** <**K737,LED mode,ISO/IEC 15415 grade,DPM grade**>
- Default:** **Standard**
- Options:** 0 = Standard      1 = ISO/IEC Grade      2 = DPM Grade

In both ISO/IEC 15415 and DPM grade modes the LEDs represent the grade of the first Data Matrix symbol read in a read cycle.

The parameter to be graded is set in the **ISO/IEC 15415 Grade** or **DPM Grade** options.

For example, to program the LEDs to indicate the ISO/IEC 15415 print growth grade, set **LED Mode** to **ISO/IEC 15415 Grade** and set **ISO/IEC 15415 Grade** to **Print Growth**. If all the LEDs from 20% to 100% were illuminated, the read result would be a grade A; if only the 20% LED were illuminated, the result would be a grade F.

### Standard (LED Configuration)

In **Standard** mode the STATUS LED indicates read cycle status and the GOOD READ LED illuminates upon a good read at the end of a read cycle. In a read rate test, these LEDs represent the percentage of good reads per images captured.

### ISO/IEC 15415 Grade (LED Configuration)

- Usage:** Provides visual validation of specific ISO/IEC 15415-related features.
- Definition:** Determines which ISO/IEC 15415 feature the reader will grade via the LEDs.
- Serial Cmd:** <**K737,LED mode,ISO/IEC 15415 grade,DPM grade**>
- Default:** **Final Grade**
- Options:** 0 = Final Grade      1 = Symbol Contrast  
2 = Print Growth      3 = Unused EEC

### DPM Grade (LED Configuration)

- Usage:** Provides visual validation of specific DPM-related features.
- Definition:** Determines which DPM feature the reader will grade via the LEDs.
- Serial Cmd:** <**K737,LED mode,ISO/IEC 15415 grade,DPM grade**>
- Default:** **Final Grade**
- Options:** 0 = Final Grade      1 = Dot Center Offset  
2 = Dot Ovality      3 = Angle of Distortion

# Serial Verification

Allows the user to verify configuration command status.

## Serial Command Echo Status

**Usage:** This command is useful in removing any doubt about the reader's interpretation of any configuration command. For example, if the current preamble is "SOM" and **<K701,1, START>** is entered, the reader will echo back **<K701, SOM>** since the attempted entry "START" exceeds the four character limit for that command. Therefore it is rejected and the existing "SOM" message is echoed back and remains the preamble message.

**Definition:** When enabled, a configuration command received from the host is echoed back to the host with the resultant settings.

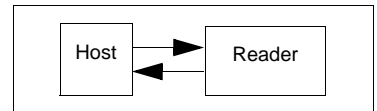

**Function:** If a command with multiple fields is processed, some of the fields may have been processed properly while others were not. The changes will appear in the string echoed back so that the user will know which fields did or did not change.

**Serial Cmd:** **<K701, serial command echo status, serial command beep status, control/hex output>**

**Default:** **Disabled**

**Options:** 0 = Disabled      1 = Enabled

## Serial Command Beep Status

**Usage:** Used to audibly verify the acceptance and validity of a command.

**Definition:** Causes the reader to beep once whenever a K command is entered to indicate that the command was accepted and processed.

**Function:** If an invalid command is entered, the reader beeps 5 times to indicate an invalid entry. However, this does not necessarily mean that all data fields have been entered incorrectly. Only one bad field needs to be found in order to activate the 5 beep response.

**Serial Cmd:** **<K701, serial command echo status, serial command beep status, control/hex output>**

**Default:** **Disabled**

**Options:** 0 = Disabled      1 = Enabled

## Control/Hex Output

- Usage:** Useful for viewing settings with binary characters when using serial command on a terminal.  
Determines the response to an **Serial Command Echo** or status request command.
- Definition:** When set to **Control**, two characters are transmitted to represent a non-displayable character. For example, a carriage return will be shown as the two characters: **^M**.  
When set to **Hex**, the output is the hex character.
- Serial Cmd:** *<K701,serial command echo status,serial command beep status,control/hex output>*
- Default:** **Control**
- Options:** 0 = Control            1 = Hex

# Video Output

**Usage:** Useful for remote visual confirmation and review of images.  
**Note:** Only available in the Quadrus EZ video option.

**Definition:** Configures the operation of video output of RS170 standard video monitors. Video source is configured via the **Active Camera** command.

The video output can be confined to a single event such as a good read or can be fed as continuous live video.

Video Output



## Video Output Mode

**Serial Cmd:** <**K760, video output mode, trigger image mode, image frame**>

**Default:** **Trigger event**

**Options:** 0 = Disabled      1 = Triggered      2 = Live (real time)

### Disabled

When selected the video output is disabled.

### Triggered

**Usage:** Ideal for dynamic applications.

**Definition:** Outputs specific capture to the video output port as per the setting in **Triggered Mode**.

### **Live (Video Output)**

**Note:** Whenever the **Locate** mode (**X**-pattern) is activated by the EZ button, **Live** video will automatically be enabled.

**Usage:** **Live** output is useful during initial setup in locating symbols in the field of view in real time.

**Definition:** The video output is configured for a real-time operating mode and is updated every video frame. If used in conjunction with Dual Camera mode, video will only output from the internal camera.

#### **Note for CCD readers:**

When **Live** video mode is active, in order to synchronize with the video format, a shutter time of 1/1000 is the slowest shutter speed setting that can be applied to the camera settings. Slower shutter speeds will disable the video output.

#### **Notes for CMOS/External Camera:**

1. When attempting to upload images, **Live** video mode should not be used. This is because the 1st image captured in a read cycle is used as a “live” video buffer when exiting the read cycle, and is continually updated with real-time image data. If this buffer is requested to be uploaded, it will no longer have the original captured image, but the last real-time image frame received.
2. If images are being saved on a noread condition, and the saved image is the 1st captured image from the most recent read cycle, then the same problem will exist as in note 1.
3. Video output is disabled during read cycle operation when configured in **Live Video Output** mode.

## Trigger Image Mode

*Definition:* Event which triggers a video output.

*Serial Cmd:* <**K760**, video output mode, **trigger image mode**, image frame>

*Default:* **Last Capture**

0 = Last Capture

1 = Good Read

*Options:* 2 = Noread

3 = Slide Show

4 = Selected Capture

### Last Capture

At the end of a triggered read cycle, the video output will be the last capture.

### Good Read

At the end of a triggered read cycle, the video output will be the last good read capture.

**Note:** If a good read does not occur, there is no video output.

### Noread

At the end of a triggered read cycle, the video output will be the last noread capture

### Slide Show

At the end of a triggered read cycle, all of the captures taken in the read cycle will be output at a rate of 350mS between captures. The last capture will be held for 700mS and then the cycle will be repeated.

**Note:** This only functions in a triggered mode.

### Selected Capture

At the end of a triggered read cycle, the video output will be the capture specified in the **Capture Number** field.

## Image Frame

*Definition:* Specifies the frame that will be output at the end of the read cycle.

*Serial Cmd:* <**K760**, video output mode, trigger image mode, **image frame**>

*Default:* **1**

*Options:* 1 to 8

# Image Output

**Usage:** Useful for remote visual examination and review of images.

**Definition:** Outputs an image file when a specified condition (good read or noread) is met. The video output can be confined to a single event such as a good read or can be fed as continuous live video.

**Serial Cmd:** `<K739,image output mode,comm port,file format,JPEG quality>`

**Default:** **Disabled**

0 = Disabled

**Options:** 1 = Good Read  
2 = Noread  
3 = Good Read *and* Noread

## **Disabled**

No image file will be output at the end of the read cycle.

## **Good Read (Image Output)**

**Usage:** Provides a visual record for comparison.

**Definition:** If a **Good Read** condition is met, the image file of the first good read image will be output, immediately following the read cycle output + postamble. In order for a good read condition to occur all symbols must qualify in the read cycle.

## **Noread (Image Output)**

**Usage:** Provides visual representation to identify quality issues with noread images.

**Definition:** If a **Noread** occurs, the image file of the first noread image will be output, immediately following the read cycle output + postamble.

Conditions where an image will not be output:

- The scanner was expecting two symbols in the same image capture but only one was read.
- The image had a good read present and therefore would not be considered a Noread image.

## **Good read and Noread (Image Output)**

**Usage:** Provides a visual record for comparison and allows the user to identify quality issues with Noread images.

**Definition:** The image file of the first **Good Read** image and the first **Noread** image will be output immediately following the read cycle output + postamble.



## Communications Port (Image Output)

*Definition:* The communications port to which the image will be sent.

*Serial Cmd:* <**K739**, *image output mode*, **comm port**, *file format*, *JPEG quality*>

*Default:* **Host**

*Options:* 0 = Host                      1 = Aux                      2 = Network

## File Format (Image Output)

*Definition:* File format of the output image.

*Serial Cmd:* <**K739**, *image output mode*, *comm port*, **file format**, *JPEG quality*>

*Default:* **JPEG**

*Options:* 0 = Bitmap                      1 = JPEG                      2 = Binary

### **Bitmap**

Outputs the image in a bitmap format.

### **JPEG**

Outputs the image in a JPEG format.

### **Binary**

Outputs the image in a raw binary format.

## JPEG Quality (Image Output)

*Definition:* Determines the relative quality of the JPEG image sent, with 100 being the highest quality.

*Serial Cmd:* <**K739**, *image output mode*, *comm port*, *file format*, **JPEG quality**>

*Default:* **90**

*Options:* 1 to 100 (where 100 is the highest quality)

# Image Captioning

- Usage:** Useful in verifying data output visually in real time.
- Definition:** Overlays text onto the specified image. The text displayed is dependent on the captioning mode that is enabled. The text captioning is overlaid onto the image frame that is output to the video port, and will be displayed on the uploaded image for that image frame as well. If more than one image frame is available in a read cycle, the image frame selected by the triggered video mode will be displayed. When the **Slide Show** video mode is enabled the text is overlaid onto every image frame prior to being output to the video port, so every image will have overlay text when uploaded.
- Serial Cmd:** **<K762,mode>**
- Default:** **Disabled**
- 0 = Disabled
- Options:**
- 1 = Read Cycle Results
- 2 = Statistic Mode 1 (counts)
- 3 = Statistic Mode (timing)

## Important Notes:

- If triggered video is not enabled this feature is disabled regardless of the mode setting.
- Only 26 characters can be displayed per line, and only 2 lines of data will be displayed. If the data string is longer than this, it will be truncated.
- 1 line of captioning takes approximately 125ms to complete overlay. Therefore, for 2 lines of overlay an additionally 250ms of overhead will have to be added to the read cycle duration.

## Disabled

Image captioning is disabled.

## Read Cycle Results (Image Captioning)

When enabled the results of the read cycle will be overlaid onto the triggered video image in the upper left hand corner. This will include Symbol data, Noread message(s) (if enabled), and any displayable formatting such as pre-amble, postamble, and Symbol ID.

**Statistic Mode 1 (counts) (Image Captioning)**

Outputs trigger count, image frame number, decode status, running read rate, good read/match count, noread count, and mismatch count. Count values are total number since reset.

**Format:**

**DECODE**            **T/XXXXX V/XXXXX**

**XXX%    F/X    N/XXXXX**

Where:

DECODE =	Decode status: "DECODE" or "NOREAD"		
T/=	Trigger count	0 - 65535	(5 digits)
V/=	Good read / Match count	0 - 65535	(5 digits)
% =	Read rate	0 - 100	(3 digits)
F/=	Image frame number	0 - 7	(1 digit)
N/=	Noread count	0 - 65535	(5 digits)
X/=	Mismatch count	0 - 65535	(5 digits)

**Important:**

- If **Match Code** is disabled, the **Mismatch** count will not be displayed.
- Read rate is calculated as a running average.

**Statistic Mode 2 (timing) (Image Captioning)**

Indicates timing information including processing time required for displayed image and total read cycle time. Also included is Decode status and image frame number.

**Format:**

**TOTAL READ TIME = XXXXX ms** (if decoded) or **STATUS** (if a noread)

**F/X READ CYCLE = XXXXX ms**

Where:

Total Read Time =	Processing time required for displayed image (1ms resolution). 1 to 65535ms (up to 5 digits)
Status =	Decode status is a NOREAD
F/=	Image frame number            0 - 7 (1 digit)
Read Cycle =	Total read cycle time (1ms resolution). 1 to 65535ms (5 digits)

# Synchronous Trigger

**Note:** This feature only applies to the CCD image sensor.

**Usage:** Helps center the image on the video display.

**Definition:** Configures the image capture trigger to be synchronous with the video frame to allow for stable video during image capture events.

**Serial Cmd:** <K761, *synchronous trigger mode*>

**Default:** **Disabled**

**Options:**  
0 = Disabled  
1 = Enabled

## **Disabled**

When disabled, the trigger event for an image capture is asynchronous with the video frame. This means that when a trigger occurs, the video timing is reset and an image capture occurs immediately. This causes flickering in an output monitor during image captures because video timing needs to resync every time the video signal is reset.

## **Enabled (synchronous trigger)**

When enabled, the trigger event for an image capture is synchronous with the video frame. This means that when a trigger occurs the image captured is not released until the start of the next video frame, which occurs every 16.68ms. The video timing never changes and no effect is seen during image captures on the video monitor.

## **Restrictions**

When the **Synchronous Trigger** mode is enabled, it will not take effect unless the following conditions are met:

1. The CCD model is in use.
2. Shutter selection is 1/1200 or faster.
3. Live Video Mode is in effect.

### **Application Notes**

1. If a **Rapid Capture** trigger mode is enabled, the timing on the trigger will change when **Synchronous Trigger** mode is enabled, and will probably not be sufficient for most applications. This is because the trigger can have up to a 16ms delta from the time the trigger is issued until the image capture occurs. Thus the trigger timing will not be stable and should not be used in a dynamic applications.
2. If the IP database is being used in a **Continuous Capture** mode, the capture sequence is sequential and no longer double buffered. Thus a capture cannot occur until the previous frame has been processed and up to a 16ms delay can be introduced between image captures.
3. In a **Continuous** trigger, **Continuous Capture**, or read rate mode, the decode speed should not be affected (while using the synchronous trigger mode) since a double buffer format is used for image capturing. The only time a slow down should be noticed in these modes is when the decode time is less than the capture time.  
Capture time = 16ms.

## EZ Button

The EZ button has four positions, selectable by the length of time that the button is held down and indicated by one, two, three, and four beeps in succession. Each position can be programmed for any of eight options.

*Definition:* Serves as a master switch to enable/disable the EZ button status.

*Serial Cmd:* **<K770,global status,default on power-on,load IP database,save for power-on>**

*Default:* **Enabled**

*Options:* 0 = Disabled      1 = Enabled      2 = Trigger

### **Disabled**

When set to **Disabled**, the EZ button is disabled.

### **Enabled**

When selected, the EZ Button is enabled and the function of each button position is selected by the EZ Button Mode command.

### **Trigger Mode (EZ Button)**

When selected, the EZ Button acts as a trigger for the reader to start and end read cycles. All other button operations are inactive.

*In External Level:* The read cycle endures for as long as the EZ button is pressed, unless a timeout occurs and **Timeout** is enabled for **End Of Read Cycle**.

*In External Edge:* As with Level, Edge allows a read cycle to be initiated by pressing the button, but unlike level mode, the read cycle ends with a good read output, a timeout, or a new trigger.

### **Default on Power-On (EZ Button)**

*Definition:* When enabled, if the EZ button is held down on power-on the reader will default to customer defaults and saved for power-on. This is the same as sending a **<Zrc>** command.

*Serial Cmd:* **<K770,global status,default on power-on,load IP database,save for power-on>**

*Default:* **Enabled**

*Options:* 0 = Disabled      1 = Enabled

## Load IP Database (EZ Button)

**Definition:** Allows the user to load the IP database with calibration results. When the user performs a calibration using the EZ button, all the database entries are moved down one index and the results of the calibration are saved to index 0. Note the results will saved as current settings as well.

**Serial Cmd:** <**K770**,global status,default on power-on,**load IP database**,save for power-on>

**Default:** **Enabled**

**Options:** 0 = Disabled 1 = Enabled

## Save for Power-On (EZ Button)

**Definition:** If enabled, after calibration is complete, all parameters will saved for power-on.

**Serial Cmd:** <**K770**,global status,default on power-on,load ip database,**save for power-on**>

**Default:** **Disabled**

**Options:** 0 = Disabled 1 = Enabled

## EZ Button Modes

**Usage:** Useful for performing multiple, repetitive tasks at the work site.

**Definition:** Allows user to program each of EZ button's 4 positions from a selection of 8 modes.

**Serial Cmd:** <**K771**,position 1 mode,position 2 mode,position 3 mode,position 4 mode>

**Options:** 0 = Disabled 1 = Enabled

<b>Single Beep</b>	<b>Two Beeps</b>	<b>Three Beeps</b>	<b>Four Beeps</b>
0 = Disabled	0 = Disabled	0 = Disabled	0 = Disabled
1 = Read rate	1 = Read rate	<b>1 = Read rate</b>	1 = Read rate
2 = Calibrate	<b>2 = Calibrate</b>	2 = Calibrate	2 = Calibrate
3 = Save for power on	3 = Save for power on	3 = Save for power on	3 = Save for power on
4 = Unused	4 = Unused	4 = Unused	4 = Unused
5 = Load new master	5 = Load new master	5 = Load new master	5 = Load new master
6 = Unused	6 = Unused	6 = Unused	6 = Unused
<b>7 = Target system</b>	7 = Target system	7 = Target system	7 = Target system
8 = Live Video	8 = Live Video	8 = Live Video	<b>8 = Live Video</b>
9 = Bar Code Config.	9 = Bar Code Config.	9 = Bar Code Config.	9 = Bar Code Config.

### ***Disabled***

When set to disabled, the associated button position will have no function associated with it, and the position will be skipped over.

### ***Read Rate***

Read rate will be initiated when the associated button position is selected. Read rate will perform decodes/second and is the same as sending a <C> from the terminal. To exit read rate mode quickly press and release the EZ Button.

### ***Calibrate***

Calibration will be initiated when the associated button position is selected. To abort calibration, quickly press and release the EZ Button.

### ***Save for Power On***

All reader settings will be saved to non-volatile memory to be recalled on power-on whenever the associated button position is selected. This is the same as sending the <Z> in the terminal.

### ***Load New Master***

Functions the same as new master pin input whenever the associated button position is selected. The new master pin's **Consecutive Decode** requirement holds true for this function.

### ***Target system***

Turns on the targeting system (X pattern) whenever the associated button position is selected. To disable, quickly press and release the EZ Button.

**Note:** This mode is the only one that does not require that the button be released before taking effect. Thus, as soon as the scanner beeps the appropriate number of times for the position, it will take effect. If it is necessary to have the target system on before another operation such as calibration or read rate is performed, ensure that the target system mode is assigned a lower position so that it will be activated first.

### ***Live Video***

Enables live video mode when the associated button position is selected. To disable, quickly press and release the EZ Button.

**Important Note:** If the user has a non-video unit and this mode is selected, it will behave the same as if the mode was disabled.

### ***Bar Code Configuration***

Enables bar code configuration mode whenever the associated button position is selected. When enabled the reader can accept configuration commands from bar codes without first reading a special, coded Data Matrix ISO/IEC 15415 symbol. To disable, quickly press and release the EZ Button.



## ***EZ Button Operation***

To execute EZ button commands,

### ***Single Beep (Position #1)***

Hold down button until a single beep is heard (and the 20% LED illuminates).

### ***Two Beeps (Position #2)***

Hold down button until two quick beeps are heard (and the 20% and 40% LEDs illuminate).

### ***Three Beeps (Position #3)***

Hold down button until three quick beeps are heard (and the 20%, 40% and 60% LEDs illuminate).

### ***Four Beeps (Position #4)***

Hold down button until four quick beeps are heard (and the 20%, 40%, 60% and 80% LEDs illuminate).

# Input 1

*Usage:* For example, an application is setup so that a mismatch stops the production line by using outputs in a latch mode. A push button switch can be connected to the input pin so that when pressed, it unlatches the output, allowing the line to resume operations.

*Definition:* A programmable, discrete input used to reset counters, outputs or control optoelectrical settings.

*Serial Cmd:* <K730, **input mode**, active state>

*Default:* **Disabled**

*Options:* 0 = Disabled      1 = Reset Counts      2 = Unlatch Output

## **Disabled**

*Definition:* When set to **Disabled** there is no effect on operation.

## **Reset Counts**

*Usage:* Primarily used in test mode. Can also be used to reset counters daily.

*Definition:* When set to **Reset Counts**, a transition to the active state of the input will cause the reader to reset the internal counters.

## **Unlatch Output**

*Definition:* This setting is used in combination with any of the three discrete outputs that are in **Unlatch Mode 1**. A transition to the active state will clear any of the three outputs that were previously latched.

## **Active State (Input)**

*Definition:* Sets the active level of the input pin.

*Serial Cmd:* <K730, input mode, **active state**>

*Default:* **Active Off**

*Options:* 0 = Active On (same as active closed)  
1 = Active Off (same as active open)

# Output 1 Parameters

**Usage:** This option provides switching to host software to control external devices such as PLCs and relays. It is useful for routing and sorting and to prevent mis-packaging and mis-routing.

**Definition:** Sets the discrete output functions for specific user-selected conditions.

## Output On (Output 1)

**Definition:** Allows the user to set the conditions under which an output (or outputs) will be activated.

**Serial Cmd:** <**K810,output on,output state,pulse width,output mode**>

**Default:** **Mismatch or Noread**

<b>Options:</b>	0 = Mismatch Or Noread	1 = Match (or good read)
	2 = Mismatch3 = Noread	4 = Trend Analysis
	5 = Symbol Quality	6 = Diagnostic Warning
	7 = In Read Cycle	

**Note:** If **Output On** is set to **Mismatch Or Noread**, **Match**, or **Mismatch**, a transition (switching) will not occur unless **Matchcode Type** is enabled and a master symbol is loaded into memory.

### **Mismatch or Noread**

Activates discrete output when the data does not match that of the master symbol or the symbol has not been decoded before the end of the read cycle.

### **Good Read/Match**

Activates a discrete output when the symbol data matches the master symbol.

**Note:** If you want to output for a good read and **Matchcode** is not enabled, you can enable any output for **Match**.

### **Mismatch**

Activates a discrete output whenever the symbol data does not match that of the master symbol.

### **Noread**

Activates a discrete output whenever the symbol data is not decoded before the end of the read cycle.

### **Trend Analysis**

*Usage:* Typically used when successful decodes are occurring but a discrete output is needed to flag a trend in a quality issues.

*Definition:* Activates discrete output when a trend analysis condition is met, depending on the trend analysis option enabled.

### **Symbol Quality**

*Usage:* Typically used when a discrete indication is needed to flag a symbol quality condition.

*Definition:* Activates discrete output when a symbol quality condition is met, depending on the symbol quality option enabled.

### **Diagnostic Warning**

*Usage:* Typically used when a discrete indication of a diagnostic condition is needed.

*Definition:* Activates discrete output when a trend analysis condition is met, depending on the trend analysis option enabled.

### **In Read Cycle**

*Definition:* Output is active while reader is operating in the read cycle.

## Output State (Output 1)

- Definition:* Sets the active electrical state of the discrete output.
- Serial Cmd:* <K810,output on,output state,pulse width,output mode>
- Default:* **Normally Open**
- Options:* 0 = Normally Open                      1 = Normally Closed

## Pulse Width (Output 1)

- Definition:* Sets the time in 10 ms increments that the discrete output remains active.
- Serial Cmd:* <K810,output on,output state,pulse width,output mode>
- Default:* **50** (Corresponds to .50S)
- Options:* 0 to 255 (0 to 2.55 seconds). Divide the number entered on the command line by 100 for time in seconds.

## Output Mode (Output 1)

- Definition:* Sets the condition in which the discrete output is de-activated.
- Serial Cmd:* <K810,output on,output state,pulse width,output mode>
- Default:* **Pulse**
- Options:* 0 = Pulse                                      1 = Latch Mode 1  
2 = Latch Mode 2                                  3 = Latch Mode 3

### Pulse

This is the default mode of operation in which the programmable output is activated when the **Output On** condition has been met and held active for the duration of the selected pulse width.

### Latch Mode 1 (Unlatch on Input 1 Pin)

The programmable output is active when the **Output On** condition has been met and held active until the discrete **Input 1** has been activated.

### Latch Mode 2 (Unlatch Opposite Condition)

The programmable output is activated when the **Output On** condition has been met and held active until the opposite condition selected under **Output On** has been met.

For example, if **Noread** is enabled under **Output On**, the programmable output will go active upon a noread and remain active until the opposite condition, a good read, occurs.

### Latch Mode 3 (Unlatch Re-enter Read Cycle)

The programmable output is active when the **Output On** condition has been met and is held active until a new read cycle begins.

**NOTE:** All of the **Output On** modes are inhibited when any **Output on Warning** is active for **Output 1** (see <K713> command).

## Trend Analysis (Output 1)

**Note:** **Output On** under **Output 1 Parameters** must be set to **Trend Analysis** for this output to function.



Under **Output 1 Parameters**, expand the **Trend Analysis** tree.

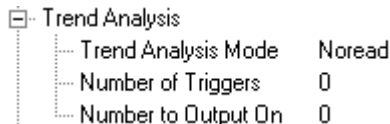

**Usage:** Useful in cases in which the user doesn't want to shut down for one condition but wants to monitor quality and read conditions.

Applies trend analysis settings to Output 1.

**Definition:** With **Trend Analysis**, the user can track the occurrences and frequency of mismatches, noreads, and the number of reads per trigger and output the results to any of three outputs.

*Trend analysis mode = Noread*

*Number of Triggers = 25*

**Example:** *Number to Output On = 4*

In this example, the reader will activate an output when 4 noreads occur within a period of 25 triggers (read cycles).

## Trend Analysis Mode

Sets the trend condition (**Mismatch**, **Noread**, or **Reads/Trigger**) that will activate the output.

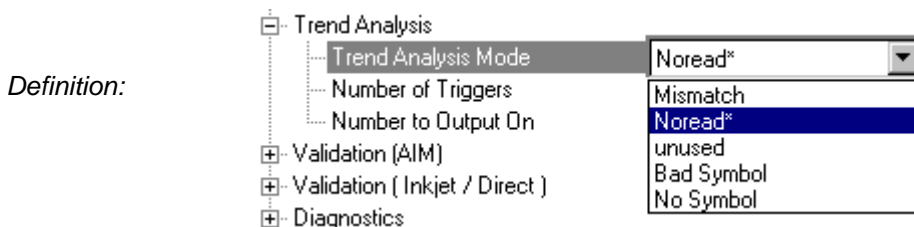

Serial Cmd: <**K780**,*trend analysis mode*,number of triggers,number to output on>

Default: **Noread**

Options:           0 = Mismatch           1 = Noread           2 = Unused  
                   3 = Bad Symbol       4 = No Symbol

### **Mismatch**

Output will be activated when the number of **Mismatches** equals the value entered for **Number to Output On** within the trigger window selected in **Number of Triggers**.

### **Noread**

Output will be activated when the number of noreads equals the value entered for **Number to Output On** within the trigger window selected in **Number of Triggers**.

### **Bad Symbol**

Output will be activated when the number of **Bad Symbol** occurrences equals the value entered for **Number to Output On** within the trigger window selected in **Number of Triggers**.

### **No Symbol**

Output will be activated when the number of **No Symbol** occurrences equals the value entered for **Number to Output On** within the trigger window selected in **Number of Triggers**.

## Number of Triggers (Trend Analysis)

*Definition:* The number of triggers to examine for the trend analysis condition.

*Serial Cmd:* <K780,trend analysis mode,number of triggers,number to output on>

*Default:* 0

*Options:* 0 to 255

## Number to Output On (Trend Analysis)

*Usage:* For example, if **Number to Output On** is set to 3 and **Trend Analysis Mode** is set to **Noread**, then the output will not be activated until 3 noreads have occurred.

*Definition:* Sets the number of **Trend Analysis Mode** events (mismatches, noreads or reads/trigger as configured by **Trend Analysis Mode**) to occur within the trigger evaluation time period before activating the associated output.

*Serial Cmd:* <K780,trend analysis mode,number of triggers,number to output on>

*Default:* 0

*Options:* 0 to 255



## Symbol Quality to Output 1 (ISO/IEC 15415)

**Note:** **Output On** under **Output 1 Parameters** must be set to **Symbol Quality** for this output to function.



Under **Output 1 Parameters**, expand the **Symbol Quality (ISO/IEC 15415)** tree.

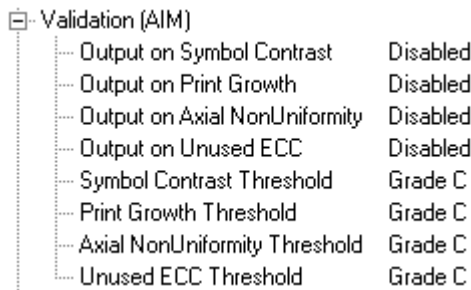

### Output on Symbol Contrast

**Usage:** Lets the user know if symbol quality is less than acceptable.

**Definition:** If enabled, toggles **Output 1** active when **Symbol Contrast Threshold** is met.

**Serial Cmd:** *<K800,output on symbol contrast,symbol contrast threshold,output on print growth,print growth threshold,output on axial non-uniformity,axial non-uniformity threshold,output on unused ecc,unused ecc threshold>*

**Default:** **Disabled**

**Options:** 0 = Disabled      1 = Enabled

### Output on Print Growth

**Usage:** Lets the user know if symbol quality is less than acceptable.

**Definition:** If enabled, toggles **Output 1** active when **Print Growth Threshold** is met.

**Serial Cmd:** *<K800,output on symbol contrast,symbol contrast threshold,output on print growth,print growth threshold,output on axial non-uniformity,axial non-uniformity threshold,output on unused ecc,unused ecc threshold>*

**Default:** **Disabled**

**Options:** 0 = Disabled      1 = Enabled

## Output on Axial Non-Uniformity

- Usage:* Lets the user know if symbol quality is less than acceptable.
- Definition:* If enabled, toggles **Output 1** active when **Axial Non-Uniformity Threshold** is met.
- Serial Cmd:* <**K800**,output on symbol contrast,symbol contrast threshold,output on print growth,print growth threshold,**output on axial non-uniformity**,axial non-uniformity threshold,output on unused ecc,unused ecc threshold>
- Default:* **Disabled**
- Options:* 0 = Disabled      1 = Enabled

## Output on Unused Error Correction

- Usage:* Lets the user know if symbol quality is less than acceptable.
- Definition:* If enabled, toggles **Output 1** when **Unused ECC Threshold** is met.
- Serial Cmd:* <**K800**,Output on Symbol Contrast,Symbol Contrast Threshold,Output on Print Growth,Print Growth Threshold,Output on Axial Non-Uniformity,Axial Non-Uniformity Threshold,**Output on Unused ECC**,Unused ECC Threshold>
- Default:* **Disabled**
- Options:* 0 = Disabled      1 = Enabled

## Symbol Contrast Threshold

- Usage:* Lets the user set the acceptable level of symbol quality.
- Definition:* Conforms to ISO/IEC 15415 symbol quality grading (A,B,C,D).
- Serial Cmd:* <**K800**,output on symbol contrast,**symbol contrast threshold**,output on print growth,print growth threshold,output on axial non-uniformity,axial non-uniformity threshold,output on unused ecc,unused ecc threshold>
- Default:* **Grade C**
- Options:* 0 = Grade A      2 = Grade C  
1 = Grade B      3 = Grade D

## Print Growth Threshold

- Usage:** Lets the user set the acceptable level of symbol quality.
- Definition:** Conforms to ISO/IEC 15415 symbol quality grading (A,B,C,D).  
<**K800**,output on symbol contrast,symbol contrast threshold,output on print growth,**print growth threshold**,output on axial non-uniformity,axial non-uniformity threshold,output on unused ecc,unused ecc threshold>
- Serial Cmd:**
- Default:** **Grade C**
- Options:** 0 = Grade A            2 = Grade C  
1 = Grade B                3 = Grade D

## Axial Non-Uniformity Threshold

- Usage:** Lets the user set the acceptable level of symbol quality.
- Definition:** Conforms to ISO/IEC 15415 symbol quality grading (A,B,C,D).  
<**K800**,output on symbol contrast,symbol contrast threshold,output on print growth,print growth threshold,output on axial non-uniformity,**axial non-uniformity threshold**,output on unused ecc,unused ecc threshold>
- Serial Cmd:**
- Default:** **Grade C**
- Options:** 0 = Grade A            2 = Grade C  
1 = Grade B                3 = Grade D

## Unused ECC Threshold

- Usage:** Lets the user set the acceptable level of symbol quality.
- Definition:** Conforms to ISO/IEC 15415 symbol quality grading (A,B,C,D).  
<**K800**,Output on Symbol Contrast,Symbol Contrast Threshold,Output on Print Growth,Print Growth Threshold,Output on Axial Non-Uniformity,Axial Non-Uniformity Threshold,Output on Unused ECC,**Unused ECC Threshold**>
- Serial Cmd:**
- Default:** **Grade C**
- Options:** 0 = Grade A            2 = Grade C  
1 = Grade B                3 = Grade D

## Symbol Quality to Output 1 (Inkjet/Direct)

**Note:** **Output On** under **Output 1 Parameters** must be set to **Symbol Quality** for this output to function.



Under **Output 1 Parameters**, expand the **Symbol Quality (Inkjet/Direct)** tree.

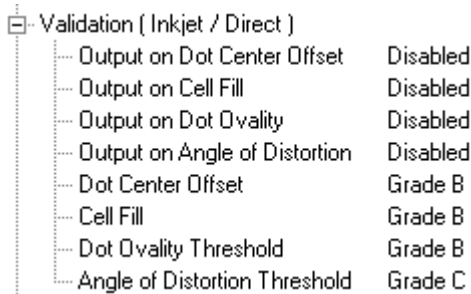

### Output on Dot Center Offset

**Definition:** When enabled, dot center offset of decoded symbols are compared to the dot center offset threshold. If the value does not meet the threshold standard, the output is asserted.

**Serial Cmd:** *<K820, output on dot center offset, dot center offset, output on cell fill, cell fill, output on dot ovality, dot ovality threshold, output on angle of distortion, angle of distortion threshold>*

**Default:** **Disabled**

**Options:** 0 = Disabled      1 = Enabled

### Output on Cell Fill

**Definition:** When enabled, cell fill of decoded symbols are compared to the cell fill threshold. If the value does not meet the threshold standard, the output is asserted.

**Serial Cmd:** *<K820, output on dot center offset, dot center offset, **output on cell fill**, cell fill, output on dot ovality, dot ovality threshold, output on angle of distortion, angle of distortion threshold>*

**Default:** **Disabled**

**Options:** 0 = Disabled      1 = Enabled

## Output on Dot Ovality

- Definition:* When enabled, dot ovality of decoded symbols are compared to the dot ovality threshold. If the value does not meet the threshold standard, the output is asserted. This has no effect when the dot is specified as a square.
- Serial Cmd:* <K820, output on dot center offset, dot center offset, output on cell fill, cell fill, **output on dot ovality**, dot ovality threshold, output on angle of distortion, angle of distortion threshold>
- Default:* **Disabled**
- Options:* 0 = Disabled      1 = Enabled

## Output on Angle of Distortion

- Definition:* When enabled, the angle of distortion of decoded symbols are compared to the angle of distortion threshold. If the value does not meet the threshold standard, the output is asserted.
- Serial Cmd:* <K820, output on dot center offset, dot center offset, output on cell fill, cell fill, output on dot ovality, dot ovality threshold, **output on angle of distortion**, angle of distortion threshold>
- Default:* **Disabled**
- Options:* 0 = Disabled      1 = Enabled

## Dot Center Offset

- Definition:* This adopts the ISO/IEC 15415 letter grades to be compared against to determine whether or not to assert the output. The <=2% (Grade A) is from Aerospace Direct Part Marking Standard Spec.
- Serial Cmd:* <K820, output on dot center offset, **dot center offset**, output on cell fill, cell fill, output on dot ovality, dot ovality threshold, output on angle of distortion, angle of distortion threshold>
- Default:* **Grade B (>2-5%)**
- Options:* 0 = Grade A (0-2%)      1 = Grade B (>2-5%)  
2 = Grade C (>5-10%)      3 = Grade D (>10%)



## Diagnostics



**Note:** When **Diagnostic Warning** is enabled under **Output 1 Parameters**, **Output Mode** configuration has no effect.

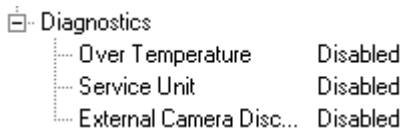

**Usage:** Alerts user to critical conditions.

Sets up specific warnings that will cause activation on output 1.

**Definition:** The output will remain active as long as one of the diagnostic conditions is met. The output will go inactive as soon as it detects no active diagnostic warning.

### Over Temperature

**Definition:** Sets up the output to toggle active when an over-temperature condition is detected.

**Serial Cmd:** <**K790,over temp**,service unit,external camera disconnect>

**Default:** **Disabled**

**Options:** 0 = Disabled      1 = Enabled

### Service Unit

**Definition:** Sets up the output to toggle active when the service timer has expired. This condition will only be held for one service timer tick.

**Serial Cmd:** <**K790,over temp**,**service unit**,external camera disconnect>

**Default:** **Disabled**

**Options:** 0 = Disabled      1 = Enabled

### External Camera Disconnect

**Note:** This feature cannot be used if in a **Continuous Read** mode.

**Definition:** Sets up the output to toggle active if the external camera goes off-line.

**Serial Cmd:** <**K790,over temp**,service unit,**external camera disconnect**>

**Default:** **Disabled**

**Options:** 0 = Disabled      1 = Enabled

# Output 2 Parameters

**Note:** Output 2 has the same parameters and default settings as Output 1.

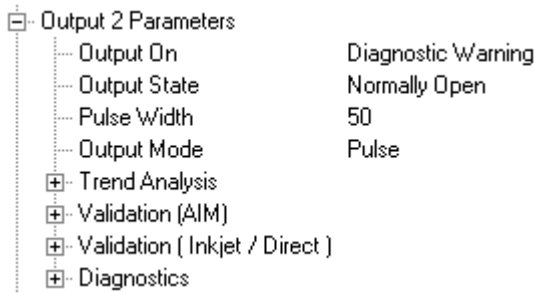

Output 2 Parameters	
Output On	Diagnostic Warning
Output State	Normally Open
Pulse Width	50
Output Mode	Pulse
Trend Analysis	
Validation (AIM)	
Validation ( Inkjet / Direct )	
Diagnostics	

Serial Cmd: <K811,output on,output state,pulse width,output mode>

## Trend Analysis to Output 2

**Note:** Output On under Output 2 Parameters must be set to Trend Analysis for this output to function.



Serial Cmd: <K781,trend analysis mode,number of triggers,number to output on>

## Symbol Quality to Output 2 (ISO/IEC 15415)

**Note:** Output On under Output 2 Parameters must be set to Symbol Quality for this output to function.



Serial Cmd: <K801,Output on Symbol Contrast,Symbol Contrast Threshold,Output on Print Growth,Print Growth Threshold,Output on Axial Non-Uniformity,Axial Non-Uniformity Threshold,Output on Unused ECC,Unused ECC Threshold>



## Symbol Quality to Output 2 (Inkjet/Direct)

**Note:** **Output On** under **Output 2 Parameters** must be set to **Symbol Quality** for this output to function.



**Serial Cmd:** *<K821,output on dot center offset,dot center offset,output on cell fill,cell fill,output on dot ovality,dot ovality threshold,output on angle of distortion,angle of distortion threshold>*

## Diagnostic Warnings to Output 2

**Note:** **Output On** under **Output 2 Parameters** must be set to **Symbol Quality** for this output to function.



**Serial Cmd:** *<K791,over temp,service unit,external camera disconnect>*

## Output 3 Parameters

**Output 3** has the same parameters and default settings as **Output 1**.

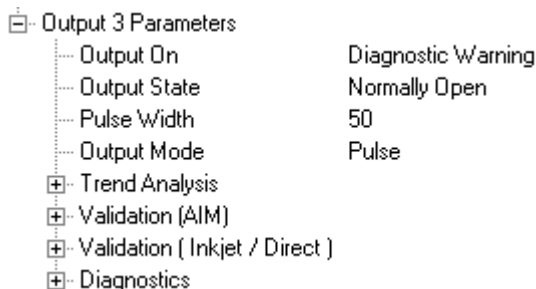

Output On	Diagnostic Warning
Output State	Normally Open
Pulse Width	50
Output Mode	Pulse
+ Trend Analysis	
+ Validation (AIM)	
+ Validation ( Inkjet / Direct )	
+ Diagnostics	

Serial Cmd: <**K812**,output on,active state,pulse width,output mode>

### Trend Analysis to Output 3

**Note:** **Output On** under **Output 3 Parameters** must be set to **Trend Analysis** for this output to function.



Serial Cmd: <**K782**,trend analysis mode,number of triggers,number to output on>

### Symbol Quality to Output 3 (ISO/IEC 15415)

**Note:** **Output On** under **Output 3 Parameters** must be set to **Symbol Quality** for this output to function.



Serial Cmd: <**K802**,Output on Symbol Contrast,Symbol Contrast Threshold,Output on Print Growth,Print Growth Threshold,Output on Axial Non-Uniformity,Axial Non-Uniformity Threshold,Output on Unused ECC,Unused ECC Threshold>

## Symbol Quality to Output 3 (Inkjet/Direct)

**Note:** Output On under Output 3 Parameters must be set to **Symbol Quality** for this output to function.



*Serial Cmd: <K822, output on dot center offset, dot center offset, output on cell fill, cell fill, output on dot ovality, dot ovality threshold, output on angle of distortion, angle of distortion threshold>*

## Diagnostic Warning to Output 3

**Note:** Output On under Output 3 Parameters must be set to **Diagnostic Warnings** for this output to function.



*Serial Cmd: <K792, over temp, service unit, external camera disconnect>*

---

*Output 3 Parameters*

# 6 Symbol Quality

## Contents

- Symbol Quality by ESP ..... 6-2
- Symbol Quality Serial Commands..... 6-2
- Overview of Symbol Quality ..... 6-3
  - Global ..... 6-4
  - Data Matrix ..... 6-5
- Static Symbol Quality Outputs..... 6-13

This section describes parameters that, when enabled, will output grades or values that evaluate symbol quality.

**Note:** The characters **NULL** <> and , can only be entered through embedded menus, not through **ESP** or serial commands.

# Symbol Quality by ESP



Click this Button to bring up the **Symbol Quality** menu.

To open nested options, **single-click** the +.

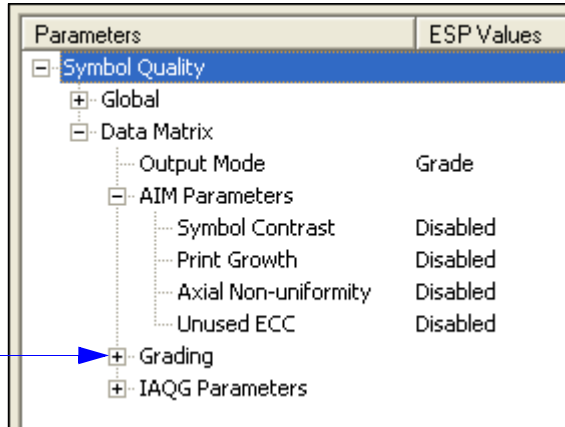

To change a setting, **double-click** the setting and use your cursor to scroll through the options.

## Symbol Quality Serial Commands

Total Read Time (global)	<K710, [not changed in this context], total read time>
Symbol Quality Separator/ Data Matrix Output Mode	<K708, symbol quality separator, data matrix output mode>
ISO/IEC 15415 Symbol Quality	<K709, symbol contrast, print growth, axial non-uniformity, unused ecc>
Grading Symbol Quality	<K710, percent cell damage, [see Total Read Time above], capture time, locate time, decode time, pixels per element, ecc level, matrix size, quiet zone>
Inkjet/Direct Symbol Qual- ity	<K711, dot shape, marking method> <K712, dot center offset, cell fill, dot ovality, angle of distortion>
Static ISO/IEC 15415/ Grading Output	<VAL>
Static Inkjet/Direct Output	<VAL2>

## Overview of Symbol Quality

Information about symbol quality and timing can be appended to symbol data output by enabling specific parameters in **ESP** or by serial command. The order that these values will be appended corresponds directly to the order in which they appear in this section and in the **ESP Symbol Quality** menu.

Symbol Quality parameters are separated into ISO/IEC 15415, Grading, and Inkjet/Direct parameters. In addition, there are two parameters, **Total Read Time** and **Symbol Quality Separator**, that are common to all.

### **Reports**

You can receive comprehensive reports by sending a **<VAL>** command to obtain an ISO/IEC 15415/Grading Symbol Quality Report or a **<VAL2>** for Inkjet/Direct Marking report.

### **Discrete Outputs**

Symbol Quality parameters can also be programmed to toggle discrete outputs in response to symbol quality changes (see "**Symbol Quality to Output 1 (ISO/IEC 15415)**" on page 5-46).

## Global

**Total Read Time** and **Symbol Quality Separator** apply to all three Symbol Quality groups: ISO/IEC 15415, Grading, and Inkjet/Direct.

### ***Total Read Time***

*Definition:* The time that transpires between the image capture and the output of the decoded data, including locate time.

If enabled, is appended to the symbol.

*Serial Cmd:* **<K710**, [not changed in this context], **total read time**>

*Default:* **Disabled**

*Options:* 0 = Disabled      1 = Enabled

### ***Symbol Quality Separator***

*Definition:* Inserts a separator between each enabled field of the symbol quality output.

*Serial Cmd:* **<K708**, **symbol quality separator**, **output mode**>

*Default:* **<SP>** (space character)

*Options:* Any ASCII character except a **NULL** **<**, **,** or **>**.



# Data Matrix

## Output Mode

**Note:** **Output Mode** applies to both ISO/IEC 15415 and Inkjet/Direct symbol quality parameters.

*Definition:* **Output Mode** specifies how the four output parameters, if enabled, are formatted.

*Serial Cmd:* <**K708**,symbol quality separator,**output mode**>

*Default:* **Grade**

*Options:* 0 = Grade                    1 = Value

### Grade

If in **Grade** mode, a grade (A,B,C,D) specified by the International Symbology Specification—Data Matrix, is appended to the symbol data.

### Value

If in **Value** mode, the calculated value for that parameter is appended to the symbol data.

## ISO/IEC 15415 Symbol Quality

Symbol Quality parameters specified by ISO/IEC 15415.

### Symbol Contrast

*Usage:* Lets the user know if contrast settings are less than acceptable.

All the pixels that fall within the area of the test symbol, including its required zone, will be sorted by their reflectance values to select the darkest 10% and the lightest 10% of the pixels. The arithmetic mean of the darkest and the lightest pixels is calculated and the difference of the two means is the Symbol Contrast.

*Definition:* (ANSI) Symbol Contrast grade is defined in this way:

A (4.0) if SC > 70%	B (3.0) if SC > 55%
C (2.0) if SC > 40%	D (1.0) if SC > 20%
F (0.0) if SC < 20%	

If enabled, the symbol contrast is appended to the symbol data according to the **ISO/IEC 15415 Symbol Quality Output Mode** setting.

*Serial Cmd:* <**K709**,symbol contrast,print growth,axial non-uniformity,unused ecc>

*Default:* **Disabled**

*Options:* 0 = Disabled                    1 = Enabled

## Print Growth

The extent to which dark or light markings appropriately fill or exceed their module boundaries. These values are determined by counting pixels in the clock pattern of the binary digitized image, then comparing it to a nominal value and Min. and Max. values. (ISO/IEC 15415) Print Growth grade is defined in this way:

*Definition:* A (4.0) if  $-.050 < D < 0.50$  B (3.0) if  $-.070 < D < 0.70$   
C (2.0) if  $-.085 < D < 0.85$  D (1.0) if  $-.1.00 < D < 1.00$   
F (0.0) if  $D < -1.00$  or  $D > 1.00$

If enabled, the print growth is appended to the symbol data according to the **ISO/IEC 15415 Symbol Quality Output Mode** setting.

*Serial Cmd:* <K709, symbol contrast, **print growth**, axial non-uniformity, unused ecc>

*Default:* **Disabled**

*Options:* 0 = Disabled 1 = Enabled

## Axial Non-Uniformity

Axial non-uniformity is a measure of how much the sampling point spacing differs from one axis to another, namely  $AN = \text{abs}(XAVG - YAVG) / ((XAVG + YAVG) / 2)$  where  $\text{abs}()$  yields the absolute value. If a symbology has more than two major axes, then AN is computed for those two average spacings which differ the most. (ANSI) Axial non-uniformity grade is defined in this way:

*Definition:* A (4.0) if  $AN < .06$  B (3.0) if  $AN < .08$   
C (2.0) if  $AN < .10$  D (1.0) if  $AN < .12$   
F (0.0) if  $AN > .12$

If enabled, the axial non-uniformity is appended to the symbol data according to the **ISO/IEC 15415 Symbol Quality Output Mode** setting.

*Serial Cmd:* <K709, symbol contrast, **print growth**, **axial non-uniformity**, unused ecc>

*Default:* **Disabled**

*Options:* 0 = Disabled 1 = Enabled

## Unused Error Correction

The correction capacity of Reed-Solomon decoding is expressed in the equation,  $e + 2d < d - p$ , where **e** is the number of erasures, **t** is the number of errors, **d** is the number of error correction code words, and **p** is the number of code words reserved for error detection.

*Definition:* The **Unused ECC** (Error Correction Code) parameter tests the extent to which regional or spot damage in the symbol has eroded the reading safety margin that error correction provides. (ISO/IEC 15415) **Unused ECC** grade is defined in this way:

A (4.0) if UEC > .62 B (3.0) if UEC > .50

C (2.0) if UEC > .37 D (1.0) if UEC > .25

F (0.0) if UEC < .25

If enabled, the unused ECC is appended to the symbol data according to the **ISO/IEC 15415 Symbol Quality Output Mode** setting.

*Serial Cmd:* <**K709**, symbol contrast, print growth, axial non-uniformity, **unused ecc**>

*Default:* **Disabled**

*Options:* 0 = Disabled      1 = Enabled

## Grading Symbol Quality

### Percent Cell Damage

- Definition:* Number of cells (also called elements) damaged per total number of cells x 100. The ideal reading is 0 (zero).  
If enabled, is appended to the symbol.
- Serial Cmd:* <K710,percent cell damage,total read time,capture time,locate time,decode time,pixels per element,ecc level,matrix size,quiet zone>
- Default:* **Disabled**
- Options:* 0 = Disabled      1 = Enabled

### Capture Time

- Definition:* Capture time (in milliseconds) is a fixed “overhead” that includes the time of capture and transfer of the image.  
If enabled, is appended to the symbol.
- Serial Cmd:* <K710,percent cell damage,total read time,capture time,locate time,decode time,pixels per element,ecc level,matrix size,quiet zone>
- Default:* **Disabled**
- Options:* 0 = Disabled      1 = Enabled

### Locate Time

- Definition:* The time in milliseconds from the start of image processing until the symbol has been located and is ready to be decoded.  
If enabled, is appended to the symbol.
- Serial Cmd:* <K710,percent cell damage,total read time,capture time,locate time,decode time,pixels per element,ecc level,matrix size,quiet zone>
- Default:* **Disabled**
- Options:* 0 = Disabled      1 = Enabled

### Decode Time

- Definition:* The time in milliseconds required to decode a symbol.  
If enabled, is appended to the symbol.
- Serial Cmd:* <K710,percent cell damage,total read time,capture time,locate time,decode time,pixels per element,ecc level,matrix size,quiet zone>
- Default:* **Disabled**
- Options:* 0 = Disabled      1 = Enabled

## Pixels per Element

- Definition:** The number of pixels for each element, either dark or light for both x and y directions.  
If enabled, is appended to the symbol.
- Serial Cmd:** <**K710**, percent cell damage, total read time, capture time, locate time, decode time, **pixels per element**, ecc level, matrix size, quiet zone>
- Default:** **Disabled**
- Options:** 0 = Disabled      1 = Enabled

## ECC Level

- Definition:** Outputs the ECC type symbology.  
If enabled, is appended to the symbol.
- Serial Cmd:** <**K710**, percent cell damage, total read time, capture time, locate time, decode time, pixels per element, **ecc level**, matrix size, quiet zone>
- Default:** **Disabled**
- Options:** 0 = Disabled      1 = Enabled

## Matrix Size

- Definition:** Defines the symbol matrix size, in number of pixels in both the x and y axis.  
If enabled, is appended to the symbol.
- Serial Cmd:** <**K710**, percent cell damage, total read time, capture time, locate time, decode time, pixels per element, ecc level, **matrix size**, quiet zone>
- Default:** **Disabled**
- Options:** 0 = Disabled      1 = Enabled

## Quiet Zone

- Definition:** If enabled, the size of the quiet zone is evaluated and a PASS or FAIL message is appended to the symbol.
- Serial Cmd:** <**K710**, percent cell damage, total read time, capture time, locate time, decode time, pixels per element, ecc level, matrix size, **quiet zone**>
- Default:** **Disabled**
- Options:** 0 = Disabled      1 = Enabled

## Inkjet/Direct Symbol Quality

Parameters related to inkjet, dot peen, and laser and chemical etching.

### Dot Shape

*Definition:* The shape of the symbol's printed or dot peen markings.

*Serial Cmd:* <K711, dot shape, marking method>

*Default:* **Round**

*Options:* 0 = Round                    1 = Square

### Marking Method

*Definition:* The marking method used to create the symbol.

*Serial Cmd:* <K711, dot shape, marking method>

*Default:* **Dot Peen**

*Options:* 0 = Dot Peen                1 = Laser or Chemical

### Dot Center Offset

Measures the deviation from the ideal dot centers. If enabled, a grade is appended to the symbol. The worst case gives the quality of the worst dot in percentage and its position in the grid. Passing grades are 80 to 100%.

Grading:

A if 0 - 2%

B if 3 - 7%

C if 8 - 13%

*Definition:* D if 14 - 20%

F if > 20%

Note that if the dot isn't a circle or an ellipse (with its major or minor axes parallel or perpendicular to the L-Pattern), then the calculated offset may be incorrect. So if a dot fails on center offset, it may only indicate that the dot is out-of-shape. Also note the ideal dot centers are based upon the prior grid-mapping calculation. It is not assumed that the cells are evenly placed, and they are adjusted if they are skewed.

*Serial Cmd:* <K712, dot center offset, cell fill, dot ovality, angle of distortion>

*Default:* **Disabled**

*Options:* 0 = Disabled                    1 = Worst Case  
          2 = Average                 3 = Both

## Cell Fill

Percentage of the ideal cell size that the dot fills. Worst Case indicates the quality of the worst dot in percentage and its position in the grid.

For dot peen symbols this is referred to as *Cell Size*, and for Laser or Chemical this is called *Cell Fill*. The calculation used for both is similar.

If enabled, the grading letter is appended to the symbol.

Grading:

A if 0 - 2%

B if 3 - 7%

C if 8 - 13%

D if 14 - 20%

F if > 20%

*Definition:*

Dot Peen, Round Laser/Chemical measures dot size from center of the dot, averages the maximum and minimum, and compares it with the ideal cell size to find the percentage.

Square Laser/Chemical measures dot size from left-right and up-down, on the angle of the symbol, averages the dimensions, and compares it with the ideal cell size to find the percentage.

*Serial Cmd:* <**K712**, dot center offset, **cell fill**, dot ovality, angle of distortion>

*Default:* **Disabled**

*Options:*

0 = Disabled	1 = Worst Case
2 = Average	3 = Both

## Dot Ovality

Identifies the extent of the oval distortion of the mark. Does not apply when the dots are specified as squares.

If enabled, the grading letter is appended to the symbol.

Grading:

A if 0 - 2%

B if 3 - 7%

*Definition:*

C if 8 - 13%

D if 14 - 20%

F if > 20%

From the center of the dot, searches left-right and up-down, or diagonally negative and positive, on the angle of the symbol to determine the dimension of the dot. The longest dimension is D, and the shortest is d, with Dot Ovality =  $(D-d) / (\text{Length of the ideal cell})$ .

*Serial Cmd:* <K712, dot center offset, cell fill, **dot ovality**, angle of distortion>

*Default:* **Disabled**

*Options:* 0 = Disabled      1 = Worst Case  
2 = Average      3 = Both

## Angle of Distortion

The angular deviation from a 90 degree plane between row and column.

If enabled, the grading letter is appended to the symbol.

Grading:

*Definition:*

A if 0 - 3.5 degrees

B if 3.6 - 7.0 degrees

C if 7.1 - 10.5 degrees

D if 10.6 - 14.0 degrees

F if > 14.0 degrees

*Serial Cmd:* <K712, dot center offset, cell fill, dot ovality, **angle of distortion**>

*Default:* **Disabled**

*Options:* 0 = Disabled      1 = Enabled



## Static Symbol Quality Outputs

When in a static capture mode, you can send a serial command immediately following a triggered output to see all of the symbol quality outputs.

**Note:** This command does not function in dynamic captures.

In the following screen captures, all the symbol quality parameters are “forced;” that is, they are displayed although not individually enabled. When you enable parameters individually, either through the **<K707...>** command or through **ESP**, the symbol quality results will be appended to the end of the symbol data.

### ***Static ISO/IEC 15415/Grading Symbol Quality Output <VAL>***

If the reader decoded a data matrix symbol in its last read cycle, sending a **<VAL>** serial command will return a report that includes ISO/IEC 15415 and Grading Symbol Quality parameters and symbol data.

### ***Static Inkjet/Direct Symbol Quality Output <VAL2>***

If the reader decoded a data matrix symbol in its last read cycle, sending a **<VAL2>** serial command will return a report that includes Inkjet/Direct symbol quality parameters and symbol data.



# 7 Matchcode

## Contents

Matchcode by ESP .....	7-2
Matchcode Serial Commands .....	7-2
Overview of Matchcode .....	7-3
Matchcode Type .....	7-4
Sequential Matching .....	7-5
Match Start Position .....	7-6
Match Length .....	7-7
Wild Card Character .....	7-8
Sequence On Noread .....	7-9
Sequence On Mismatch .....	7-10
Sequence Step .....	7-11
Match Replace .....	7-12
Mismatch Replace .....	7-13
New Master Pin .....	7-14

This section explains the matchcode output functions and the master symbol database setup.

**Note:** The characters **NULL <>** and **,** can only be entered through embedded menus, not through **ESP** or serial commands.

# Matchcode by ESP



Click this button to bring up the **Matchcode** menu.

To open nested options, **single-click** the +.

To change a setting, **double-click** the setting and use your cursor to scroll through the options.

## Matchcode Serial Commands

Matchcode Type	< <b>K223</b> , type, sequential matching, match start position, match length, wild card character, sequence on noread, sequence on mismatch>
Sequence Step	< <b>K228</b> , sequence step>
Match Replace	< <b>K735</b> , status, replacement string>
Mismatch Replace	< <b>K736</b> , status, replacement string>
New Master Pin	< <b>K225</b> , status>
Number of Master Symbols	< <b>K224</b> , number of master symbols>
Enter Master Symbol Data	< <b>K231</b> , master symbol number, data>
Read Next Symbol as Master Symbol	< <b>G</b> master symbol number>
Request Master Symbol Data	< <b>K231?</b> ,>[for all] or < <b>K231?</b> , master symbol number>
Delete Master Symbol Data	< <b>K231</b> , master symbol number,>

# Overview of Matchcode

With **Matchcode** you can store master symbol data in the reader's memory, compare this data against the read symbols, and define how symbol data and/or discrete signal output will be directed.

*Definition:* A master symbol database can be setup for up to 10 master symbols.

**Note:** **Matchcode** will function with multiple symbols; however if **Matchcode Type** is set to **Sequential** or if **Triggering Mode** is set to **Continuous Read 1 Output**, **Number of Symbols** will default back to **1** (if set to any number greater than 1).

*Usage:* **Matchcode** is used in applications to sort, route, or verify data based on matching the specific symbol in a variety of ways as defined in this section. For example, a manufacturer might sort a product based on dates that are embedded in the symbol.

## **Steps for Entering and Using Master Symbols**

1. Set **Triggering Mode** to **External** or **Serial**.
2. Chose the method of symbol comparison that fits your application.
3. Define the output you want to achieve with your matchcode setup.
4. Select the number of master symbols you want to create.
5. Decide which of 4 ways you want enter your master symbol(s):
  - a) Use **ESP** to type in master symbol data directly;
  - b) Send a serial command with symbol data in the form of **<M231, master symbol#, data>**;
  - c) Send a **<G>** (Read Next Symbol as Master Symbol) command;
  - d) Enable the **New Master Pin** command and activate a discrete input to store the next symbol read as master symbol.
6. Enter master symbol data using the method determined in step 4.

# Matchcode Type

**Definition:** Allows the user to choose the way that master symbols will be compared with subsequently read symbols.

**Note:** First set **Triggering Mode** to **External** or **Serial**.

ESP:

Parameters	ESP Values
<input type="checkbox"/> Matchcode	
Matchcode Type	Disabled
Sequential Matching	Increment
Match Start Position	0
Match Length	1
Wild Card	*
Sequence on Noread	Enabled
Sequence on Mismatch	Disabled
Sequence Step	1
New Master Pin	Disabled

**Serial Cmd:** <**K223, matchcode type**, sequential matching, match start position, match length, wild card character, sequence on noread, sequence on mismatch>

**Default:** **Disabled**

**Options:** 0 = Disabled      1 = Enabled  
2 = Sequential      3 = Wild Card

**Disabled:** Has no effect on operations.

**Enabled:** Instructs the reader to compare symbols or portions of symbols with the master symbol.

**Sequential:** Instructs the reader to sequence after each match (numeric only) and compare symbols or portions of symbols for sequential numbers.

**Note:** If **Matchcode Type** is set to **Sequential**, **Number of Symbols** will default back to **1** (if set to any number greater than 1).

**Wild Card:** Allows the user to enter user defined wild card characters in the master symbol.

# Sequential Matching

- Usage:* Useful in tracking product serial numbers that increment or decrement sequentially.
- Definition:* With **Sequential** enabled, **Sequential Matching** determines if a count is in ascending (incremental) or descending (decremental) order.
- Serial Cmd:* <**K223**, matchcode type, **sequential matching**, match start position, match length, wild card character, sequence on noread, sequence on mismatch>
- Default:* **Increment**
- Options:* 0 = Increment      1 = Decrement

# Match Start Position

- Match Start Position** is useful in defining specific portions of a symbol for comparisons. For example, if a symbol contains a part number, manufacturing date, and lot code info but the user is only interested in the part number information. With **Match Start Position** the reader can be set to only sort on the part number and ignore the rest of the characters.
- Match Start Position** determines the portions of symbols that will be matched by defining the first character in the symbol (from left to right) that will be compared with those of the master symbol, when **Matchcode Type** is set to **Enabled** or **Sequential**.
- For example, if **Match Start Position** is set to 3, the first 2 characters read in the symbol will be ignored and only the 3rd and subsequent characters to the right will be compared, up to the number of characters specified by **Match Length**.
- Serial Cmd:** *<K223,matchcode type,sequential matching,match start position,match length,wild card character,sequence on noread,sequence on mismatch>*
- Default:** **0**
- Options:** 0 to 2710

**Note:** **Match Start Position** must be set to **1** or greater to enable this feature. A **0** setting will disable this feature.



---

## Match Length

- Usage:* For example, if **Match Length** is set to **6** in a 10 character symbol, and **Match Start Position** is set for **2**, only the 2nd through 7th characters (from left to right) will be compared.
- Definition:* Defines the length of the character string that will be compared with that of the master symbol when **Match Start Position** is set to **1** or greater. when **Match Start Position** is set to **0**, no comparison will occur.
- Serial Cmd:* **<K223, matchcode type, sequential matching, match start position, match length, wild card character, sequence on noread, sequence on mismatch>**
- Default:* **1**
- Options:* 1 to 2710

## Wild Card Character

- Usage:* For example, with **Wild Card Character** defined as the default asterisk, defining **CR\*34** as the master symbol will result in matches for CR134, CR234, but not CR2345. Entering the wild card at the end of the master symbol as in **CR\*** will result in matches for variable symbol lengths such as CR1, CR23, CR358, etc.
- Definition:* **Wild Card Character** allows a user to define a wild card character as part of the master symbol.
- Serial Cmd:* <**K223**,matchcode type,sequential matching,match start position,match length,**wild card character**,sequence on noread,sequence on mismatch>
- Default:* \* (asterisk)
- Options:* Any valid ASCII character

## Sequence On Noread

*Usage:* **Sequence On Noread** is useful when the reader needs to stay in sequence even if no decode occurs.

*Definition:* When **Sequence On Noread** is **Enabled** and **Matchcode** is set to **Sequential**, the reader sequences the master symbol on every match or noread. When disabled, it does not sequence on a noread.

*Serial Cmd:* <**K223**, matchcode type, sequential matching, match start position, match length, wild card character, **sequence on noread**, sequence on mismatch>

*Default:* **Enabled**

*Options:* 0 = Disabled      1 = Enabled

As an example of **Sequence on Noread Enabled**, consider the following series of decodes:

<i>Master symbol</i>	<i>Decoded symbol</i>	<i>Master symbol after decode</i>
001	001	002
002	002	003
003	noread	004 (sequenced on noread)
004	004	005
005	noread	006 (sequenced on noread)
006	noread	007 (sequenced on noread)
007	007	008

As an example of **Sequence on Noread Disabled**, consider the following series of decodes:

<i>Master symbol</i>	<i>Decoded symbol</i>	<i>Master symbol after decode</i>
001	001	002
002	002	003
003	noread	003 (not sequenced)
003	003	004
004	noread	004 (not sequenced)
004	noread	004 (not sequenced)
004	004	005

# Sequence On Mismatch

**Note:** Matchcode must be set to **Sequential** for this command to function.

*Usage:* Enable this parameter if every trigger event should have a decode and more than one consecutive mismatch may occur.  
 Disable this parameter if every trigger event should have a decode but no more than one consecutive mismatch may occur.

*Definition:* When set to **Enabled**, the master symbol sequences on every decode, match or mismatch.

When set to **Disabled**, the master symbol will not sequence whenever consecutive mismatches occur.

*Serial Cmd:* <**K223**, matchcode type, sequential matching, match start position, match length, wild card character, sequence on noread, **sequence on mismatch**>

*Default:* **Disabled**

*Options:* 0 = Disabled      1 = Enabled

The reader will sequence the master to one more/less than the decoded symbol. As an example of **Sequence On Mismatch Enabled**, consider the following decodes:

<i>Master symbol</i>	<i>Decoded symbol</i>	<i>Master symbol after decode</i>
001	001	002
002	002	003
003	abc	004 (sequenced on mismatch)
004	004	005
005	def	006 (sequenced on mismatch)
006	ghi	007 (sequenced on mismatch)
007	007	008

As an example of **Sequence On Mismatch Disabled**, consider the following decodes:

<i>Master symbol</i>	<i>Decoded symbol</i>	<i>Master symbol after decode</i>
001	001	002
002	002	003
003	abc	004 (sequenced because of previous match)
004	004	005
005	def	006 (sequenced because of previous match)
006	ghi	006 (not sequenced because of previous mismatch)
006	006	007

## Sequence Step

**Usage:** Useful in applications in which it is desirable to count by intervals other than 1. Sequencing in **Matchcode** operations can occur in steps from 1 to 32,768.

**Definition:** Sequencing performs like a mechanical counter by displaying positive integers and a specific number of digits after roll-overs. For example, 000 – 3 = 997 (not –3) and 999 + 3 = 002 (not 1002).

**Serial Cmd:** <**K228**, sequence step>

**Default:** **1**

**Options:** 1 to 32,768

As an example of **Sequence Step**, if **Sequence Step** is set to **3** and **Sequential Matching** is set to **Increment**.

<i>Master symbol</i>	<i>Decoded symbol</i>	<i>Master symbol after decode</i>
003	001	003
003	002	003
003	003	006
006	004	006
006	005	006
006	006	009

## Match Replace

- Usage:* Provides a convenient shortcut for applications that need to output a pre-defined text string whenever a symbol matches a master symbol.
- Definition:* Outputs a user-defined data string whenever a match occurs and **Matchcode** is enabled.
- Serial Cmd:* **<K735, status, replacement string>**
- Default:* **Disabled**
- Options:* 0 = Disabled      1 = Enabled

## Replacement String

- Definition:* User-defined string that when enabled will replace the matchcode data.
- Serial Cmd:* **<K735, status, replacement string>**
- Default:* **MATCH**
- Options:* Any ASCII string up to 128 characters.

---

## Mismatch Replace

- Usage:* Provides a convenient shortcut for applications that need to output a pre-defined text string whenever a symbol does not match a master symbol.
- Definition:* Outputs a user-defined data string whenever a mismatch occurs and **Matchcode** is enabled.
- Serial Cmd:* <**K736, status, replacement string**>
- Default:* **Disabled**
- Options:* 0 = Disabled      1 = Enabled

### ***Replacement String***

- Definition:* User-defined string that when enabled will be output whenever a mismatch occurs.
- Serial Cmd:* <**K736, status, replacement string**>
- Default:* **MISMATCH**
- Options:* Any ASCII string up to 128 characters.

## New Master Pin

*Usage:* Some applications require the line worker to change the master symbol. This can be done by installing a switch at the location of the reader. It is very common to have a keyed switch so that accidental switching does not occur.

After **New Master Pin** is enabled, a pulse can be received on the new master pin that will cause the reader to record the next decoded symbol(s) as the new master symbol(s).

*Definition:* It is important to note that the enabling **New Master Pin** does not in itself cause a master symbol to be recorded. The master pin must then be activated momentarily (for a minimum of 10 ms) before a master symbol can be read into memory.

*Serial Cmd:* <K225,status>

*Default:* **Disabled**

*Options:* 0 = Disabled      1 = Enabled

After **New Master Pin** has been enabled and the pin activated, decodes will be saved in the master database beginning with master symbol #1. If the reader is configured for a multisymbol read cycle (**Number of Symbols** is greater than 1), the remaining decodes will be saved in each consecutive master symbol location. For example, if **Number of Symbols** is set to 3 and **New Master Pin** is then activated, at the end of the next read cycle, the decoded symbols will be saved as master symbols 1, 2, and 3.



# 8 Diagnostics

## Contents

Diagnostics by ESP.....	8-2
Diagnostics Serial Commands .....	8-2
Counts (Read Only).....	8-3
External Camera Message.....	8-4
Over Temperature Message .....	8-6
Service Message.....	8-7

This section describes warning and operating messages and their settings.

**Note:** The characters **NULL** <> and , can only be entered through embedded menus, not through **ESP** or serial commands.

# Diagnostics by ESP



Click this button to bring up the **Diagnostics** menu.

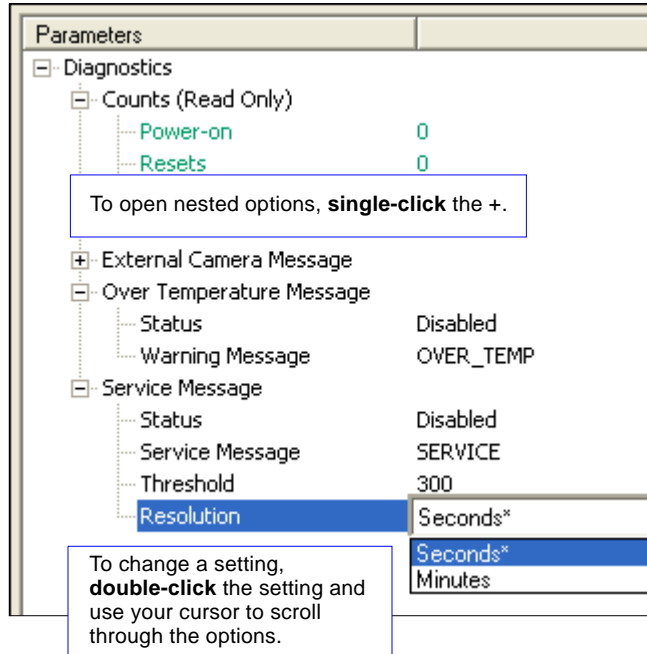

The screenshot shows a 'Parameters' window with a tree view under 'Diagnostics'. The tree includes 'Counts (Read Only)' with sub-items 'Power-on' (0) and 'Resets' (0); 'External Camera Message'; 'Over Temperature Message' with sub-items 'Status' (Disabled) and 'Warning Message' (OVER\_TEMP); and 'Service Message' with sub-items 'Status' (Disabled), 'Service Message' (SERVICE), 'Threshold' (300), and 'Resolution'. The 'Resolution' item is selected, and a dropdown menu is open showing 'Seconds\*' and 'Minutes'. Two callout boxes provide instructions: one for opening nested options by clicking the '+' sign, and another for changing a setting by double-clicking and scrolling through options.

## Diagnostics Serial Commands

Power-on/Reset Counts	< <b>K406</b> , power-on, resets, power-on saves, customer default saves>
External Camera Message	< <b>K410</b> , disconnect msg status, disconnect message, connect msg status, control message>
Over Temperature Message	< <b>K402</b> , over temperature status, warning message>
Service Message	< <b>K409</b> , status, service message, threshold, resolution>

## Counts (Read Only)

Counts for Power-on/Reset/Saves are stored in the reader and can be displayed at any time in response to serial commands listed here, in the embedded **Diagnostic** menu, or in **ESP** by requesting reader settings. If you did not choose to receive reader settings upon connection in **ESP**, you can right-click anywhere in the **Diagnostic** window and select **Receive Reader Settings**.

### Power-on

*Definition:* Displays a count of the number of times power to the reader is recycled.

*Serial Cmd:* <K406, power-on, resets, power-on saves, customer default saves>

### Resets

*Definition:* Displays a count of the number of times the reader is reset.

*Serial Cmd:* <K406, power-on, resets, power-on saves, customer default saves>

### Power-on Saves

*Definition:* Displays a count of the number of power-on saves <Z> command.

*Serial Cmd:* <K406, power-on, resets, power-on saves, customer default saves>

### Custom Default Saves

*Definition:* Displays a count of the number of power-on saves (customer defaults) to flash memory (<Zc> command)

*Serial Cmd:* <K406, power-on, resets, power-on saves, customer default saves>

## External Camera Message

**Note:** This feature cannot be used if in a **Continuous Read** mode.

### Disconnect Status

**Definition:** When enabled, a message is sent when the system detects that the external camera is not connected.

**Conditions:** On power-on, if enabled and the external camera is not connected, the “disconnect message” will be output. The message will not be output again unless power is cycled or a “disconnect” condition occurs after a “connect” condition with connect message enabled.

**Note:** If the external camera is configured in “Interlaced” mode instead of “Progressive,” this will be detected as a Disconnect condition.

**Serial Cmd:** <**K410, disconnect msg status, disconnect message, connect msg status, connect message**>

**Default:** **Disabled**

**Options:** 0 = Disabled      1 = Enabled

### Disconnect Message

**Serial Cmd:** <**K410, disconnect msg status, disconnect message, connect msg status, connect message**>

**Default:** EX\_CAM\_OFF

**Options:** Any 1 to 10 ASCII characters except **NULL < , or >**.

### Connect Status

**Definition:** When enabled, a message is sent when the system detects that the external camera is connected.

**Conditions:** On power-on, if enabled and the external camera is connected, the “connect message” will be output. The message will not be output again unless power is cycled or a “connect” condition occurs after a “disconnect” condition with connect message enabled.

**Note:** If the external camera is configured in “Interlaced” mode instead of “Progressive,” this will not be detected as a connect condition.

**Serial Cmd:** <**K410, disconnect msg status, disconnect message, connect msg status, connect message**>

**Default:** **Disabled**

**Options:** 0 = Disabled      1 = Enabled

## **Connect Message**

*Serial Cmd:* <**K410**, disconnect msg status, disconnect message, connect msg status, **connect message**>

*Default:* EX\_CAM\_ON

*Options:* Any 1 to 10 ASCII characters except **NULL < , or >**.

## Over Temperature Message

### ***Over Temperature Status***

*Usage:* Helps ensure that the reader is being used within its temperature specification.

*Definition:* When enabled, a message is sent whenever the system detects that the internal temperature has exceeded its specified operating temperature.

*Serial Cmd:* <**K402,over temperaturestatus,warning message**>

*Default:* **Disabled**

*Options:* 0 = Disabled      1 = Enabled

### ***Warning Message***

*Serial Cmd:* <**K402,over temperature status,warning message**>

*Default:* OVER\_TEMP

*Options:* Any 1 to 10 ASCII characters except **NULL <, or >**.

# Service Message

## Service Message Status

When enabled, a message is sent whenever the system detects that a user-set service time has expired.

*Definition:* The service timer is reset on power-on, thus the timer only records the time that has elapsed since the last reset.

The message is sent every time the timer expires.

*Serial Cmd:* <**K409,status,service message,threshold,resolution**>

*Default:* **Disabled**

*Options:* 0 = Disabled      1 = Enabled

## Service Message

*Serial Cmd:* <**K409,status,service message,threshold,resolution**>

*Default:* **SERVICE**

*Options:* Any 1 to 10 ASCII characters except **NULL < , or >**.

## Threshold

*Definition:* Sets the number of hours or minutes that will transpire before the service message is output.

*Serial Cmd:* <**K409,status,service message,threshold,resolution**>

*Default:* **300** (5 minutes)

*Options:* 1 to 65,535

## Resolution

*Definition:* Records time in seconds or minutes.

*Serial Cmd:* <**K409,status,service message,threshold,resolution**>

*Default:* **Seconds**

*Options:* 0 = Seconds      1 = Minutes

---

*Service Message*



# 9 Camera Setup

## Contents

Camera Setup by ESP .....	9-2
Camera Setup Serial Commands.....	9-2
Video .....	9-3
Evaluation.....	9-5
Region of Interest (ROI) .....	9-8
Dynamic Setup .....	9-12
CCD Image Sensor .....	9-14
CMOS Image Sensor .....	9-15
Illumination Source.....	9-17
Thresholding.....	9-18
Image Processing Settings.....	9-19
Hollow Mode.....	9-21
Mirrored Image .....	9-22
Other Camera Parameters .....	9-23

This section provides adjustment to the physical controls of the internal camera, image acquisition, database settings, and image diagnostics.

**Note: Camera Setup** only applies to the Quadrus EZ internal camera. If using an external camera, images are received on an as-ready basis. Allow a 33mS delay for the first image to appear from an external camera.

Note also that the Quadrus EZ may have one of two types of image sensors, CCD or CMOS. Even though some of the parameters between the sensors are similar, they are configured independently with different configuration commands. Therefore, the user needs to know which sensor type is installed in the Quadrus EZ. This can be determined with the **<op,10>** command.

# Camera Setup by ESP



Click this Button to bring up the **Camera Setup** menu

To open nested options, **single-click** the +.

To change a setting, **double-click** the setting and use your cursor to scroll through the options.

Parameters	
[-] Camera Setup	
[-] CCD Image Sensor	
Gain	550
Shutter Speed	1000
[-] CMOS Image Sensor	
Shutter Speed	250
Gain	10
Contrast	2
Offset	0
Illumination Source	Internal (inner and outer rings)
[-] Thresholding	
Threshold Mode	Adaptive
Threshold Value	128
[-] Image Processing Settings	
Narrow Margin Status	Disabled
Symbology ID Status	Disabled
Background Color	White
Mirrored Image	Regular Image*
Multisymbol	Regular Image*
Number of Symbols	Mirrored Image
Multisymbol Separator	,

## Camera Setup Serial Commands

Region of Interest	< <b>K516</b> , <i>top,left,height,width</i> >
CCD Image Sensor	< <b>K540</b> , <i>shutter speed,gain</i> >
CMOS Image Sensor	< <b>K541</b> , <i>shutter speed,gain,contrast,offset</i> >
Illumination Source	< <b>K535</b> , <i>illumination source</i> >
Thresholding	< <b>K512</b> , <i>threshold mode,threshold value</i> >
Image Processing Mode	< <b>K513</b> , <i>processing mode</i> >
Multiple Symbols in Fast Linear Mode	< <b>K518</b> , <i>number of symbols</i> >
Image Processing Timeout	< <b>K245</b> , <i>image processing timeout</i> >
Hollow Mode	< <b>K517</b> , <i>hollow status</i> >
Mirrored Image	< <b>K514</b> , <i>mirrored image</i> >

## Video

In the **Camera** menu you can locate and capture images just as you did in the **EZ Mode** when first starting **ESP**.

### Locate

Turns on the blue **X**-pattern to help you center the symbol in the field of view.

### Calibrate

If you haven't already calibrated the symbol,

1. Click the **Locate** button and center the **X** pattern over the symbol.
2. Click the **Calibrate** button to optimize read rate.

The reader will search through various IP (image processing) settings and match them with the highest read rates.

A successful calibration will display the calibrated symbol image a message, "Calibrated successfully".

3. Click **Close** on the **Calibration** dialog.

After a short wait, the symbol's data and related features will be presented under the "Symbol Information" box below the image display window, as shown in the following example:

Attribute	Value
Calibrate	
Progress	Completed successfully. Parameters uploaded.
Number of Symbols	1
Symbol #1	
Symbol Data	Microscan
Symbol Type	2D
Symbol ID	jd0
Foreground pixels	0.0
Background pixels	0.0
Percent Cell Damage	0 %
Contrast	57

### Calibrate by Serial Command

Send **<op,6,1>** to begin calibration. Send **<op,6,0>** to terminate calibration.

## Capture and Decode

After calibration, click the **Capture and Decode** button.

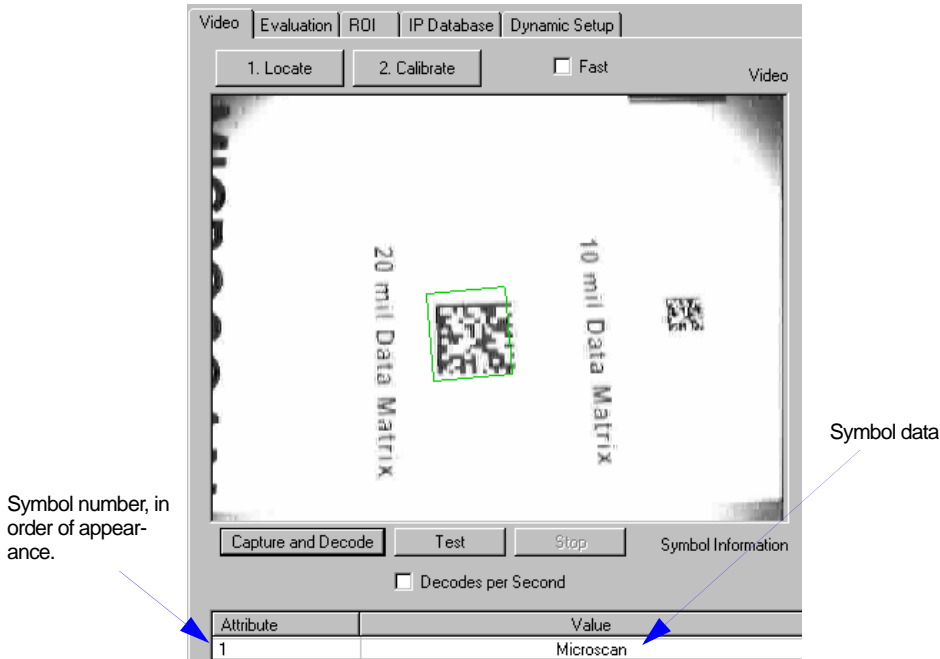

### Capture and Decode

Notice that following a capture and successful decode:

- 1D symbols have a green line through them.
- 2D symbols are surrounded by green boxes.

The new settings are uploaded to **ESP** and displayed in the **Symbol Information** box below the **Video** screen.

## Test (Video Capture)

1. With your calibrated symbol in the recommended position, click the **Test** button.

Notice that the **Number Of Symbols** decoded is posted and **Percent/Decode** is dynamically updated. You can also click the **Decodes per Second** checkbox which shifts the output from **Percent Decode** to **Decodes/Second**. Un-clicking it returns the output to **Percent Decode**.

2. Click **Stop** to end the read rate test.

## Evaluation

In **Evaluation**, you can view images currently in the reader, capture and decode a symbol, save it as a digital file, and perform histogram and line scan evaluations.

When you click on the **Evaluation** tab, you will see the images that are currently stored in the reader.

Click **Receive** to refresh the view.

Click **Capture/Decode** to display the current image in the scanner. Only one capture/decode event will occur regardless of read cycle settings.

Click **Read** to trigger a read cycle. If there's enough time in the read cycle up to 8 good reads can be captured and displayed depending on the number enabled in **Number of Captures** under **Capture Mode** in the **Camera Setup** menu tree to the left of the tabs.

If you click **Save**, the current image will be saved to as a file to the location of your choice.

**Note:** An image can only be saved in the format that the image was captured in. JPEG images will be saved as a **.jpg**, bitmaps as a **.bmp**.

When you click the **JPEG Image** box, notice that the **Line Scan** Button is grayed out.

The JPEG option allows faster captures and transfers, but since the JPEG standard compresses image data, it is not suitable for the more rigorous demands of a line scan evaluation.

JPEG also allows you to adjust the image quality (resolution) by adjusting the sliding tab between 1 and 100, 1 being the lowest quality and 100 the highest.

When possible, use the highest quality; when not, speed up image transfers by using a lower quality setting. Adjustments for this setting will depend on your specific hardware/software limitations.

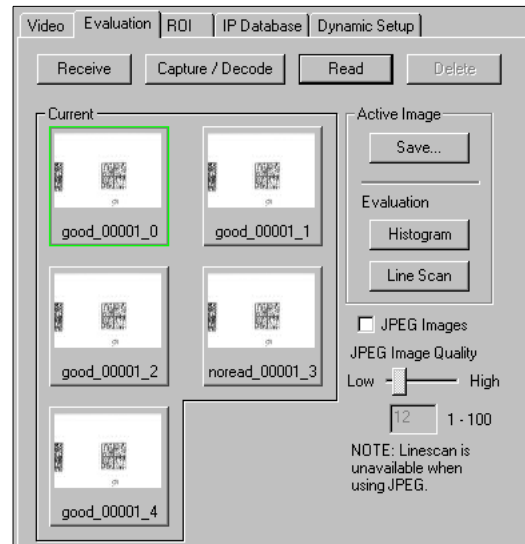

*Evaluation*

## Histogram

**Usage:** Useful in determining quality and contrast of symbols.

**Definition:** A histogram is a graphical presentation of the numeric count of the occurrence of each intensity (gray level) in an image. The horizontal axis is the values of gray levels and the vertical axis is the number of pixels for each gray level.

**Note:** Since histograms are performed in the reader, the results will be save regardless of whether the image was captured as a BMP or JPG.

1. From the **Evaluation** window, click the **Histogram** button.  
The current image is transferred into the histogram operation. This may take a moment since all relevant pixels are being evaluated intensively.
2. When the **Histogram** window opens, you might need to expand the window and/or adjust the scroll bars in order to bring the image into view.
3. To generate a histogram, click and drag your mouse pointer diagonally across the symbol or a portion of it.

### Threshold (Histogram)

**Enable Autothreshold** is checked by default.

To manually adjust the threshold,

1. Uncheck the **Enable Autothreshold** checkbox.
2. Move the threshold **marker** (vertical green dashed line) in the Histogram chart.  
**Hint:** This should be midway between the maximum and minimum curves.
3. Click on the **Send Threshold** button to adopt the new threshold position.

### Histogram Evaluation

In a histogram, the first peak from the left is the **Low Peak**. Its highest point occurs at **20** in the dark-to-light range. The next peak is the **High Peak** which occurs at **141**.

The minimum (dark) and maximum (light) represent the entire range of pixels that are derived from the capture.

Threshold is the mean setting and represented by a vertical dashed green line. In practical terms, the threshold represents the point at which all pixels on the left are regarded as dark and all to the right as light.

You can adjust the threshold by unchecking the **Enable Autothreshold** checkbox, moving the threshold and clicking **Send Threshold** to save the new setting.

## Line Scan

1. From the **Evaluation** tab, click the **Line Scan** button.  
The window shown below appears.

**Hint:** When the **Histogram** window opens, you might need to expand the window and/or adjust the scroll bars in order to bring the image into view.

2. Drag your mouse pointer across the image, horizontally.

It will create a dashed horizontal line. Pixel information and a visual representation of the dark and light pixels will be displayed below the image.

When you center your cursor over the dashed line, it becomes a double arrow cross. This will allow you to move this line anywhere in the window. You can also use your keyboard arrows to move this line incrementally in any direction.

As with the histogram, the line scan compares light and dark pixels, but in a spacial distribution. On the Y axis of the graph, 0 is black and 255 is white; the X axis represents the horizontal axis of the symbol as described by the line scan.

When you click anywhere on the graph, a vertical red line appears at that point and its position and value (in terms of black to white) are updated in the **Pixel Info** table to the left of the graph, in this case 237. In addition, a horizontal, dashed red line is displayed that indicates the average value.

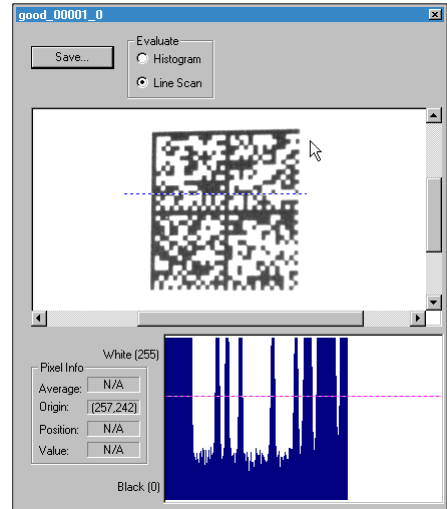

*Line Scan*

## Region of Interest (ROI)

You can narrow the active image area (field of view) by defining a specific area or region of interest.

This is especially useful for increasing decode speed, improving threshold, and selecting the desired symbol from multiple symbols the FOV.

### Notes:

1. When using video output, the “Region of Interest” image will only be shown in triggered video mode. When in live video mode, the entire image from the image sensor will be shown.
2. If external camera is in use the maximum row and column size is the same as the CMOS image sensor. However, if the unit has a CCD camera, the command will range check for the CCD and will allow a larger row and column size than the sensor has. The overall operation of the Window of Interest will not be effected if a larger row or column size is selected.
3. The “Region of Interest” can be disabled by setting all values to 0 or setting the “Region of Interest” area to equal the image sensor area.

 Region of Interest	
Top	0
Left	0
Height	0
Width	0

**Caution: Region of Interest** will shrink the field of view and therefore could cause symbols to be missed in dynamic applications.



## Region of Interest by ESP

1. From the **Camera** menu, click the **ROI** tab to bring up **Region of Interest**.

If you haven't already captured an image, click the **Capture and Decode** button to decode the present image. If successful, the **Good Read** indicator on the **ROI** tab will be green and the symbol will appear in the pane below.

**Note:** You can resize the image by clicking and dragging the **ESP** window from the lower right corner. This is useful where very small symbols are being read.

2. Click and drag your cursor over the symbol that you want to isolate for reading.

Notice that the surrounding area goes black.

You can use the handles on the image area that you have just drawn to resize the region of interest. You can also click on the center of the region of interest and move it about.

3. Test the new settings in Read Rate mode.

**Note:** to remove the region of interest, click the **Reset** button or just click anywhere in the ROI pane.

Note that all pixels not in the ROI are defined as black.

Because the Quadrus EZ has much less processing to do in a smaller window, read rates typically increase dramatically. One possible downside is that the chance of missing a symbol increases with the smaller window. Always verify that your ROI will be large enough to allow for any random movement of symbols in your FOV.

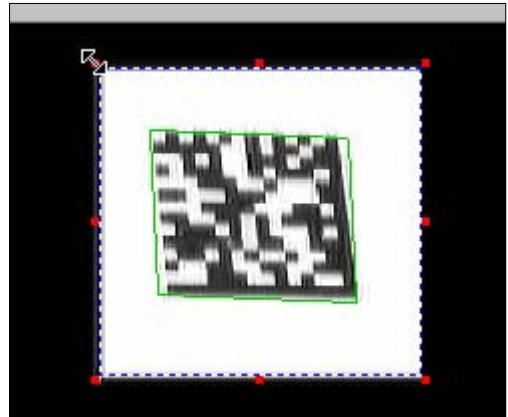
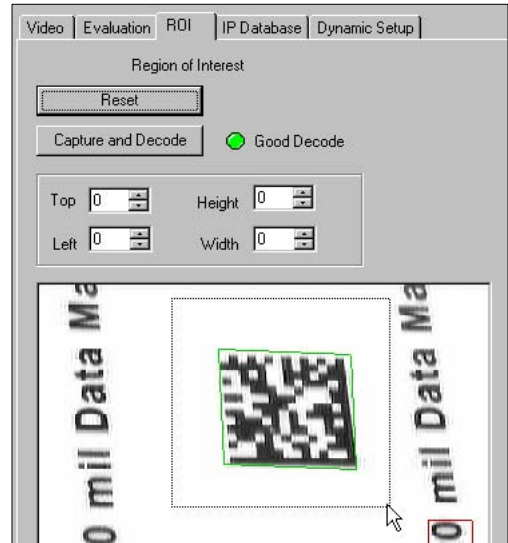

## Region of Interest by Serial Command

The exact size and position of the ROI within the image area can be defined numerically in terms of pixels.

“Region of Interest Parameters” shows where to locate the start position of the row and column pointers and how to measure the column depth and row width dimensions.

Note that the CMOS model has a different number of pixels from the CCD in both the column and row dimensions.

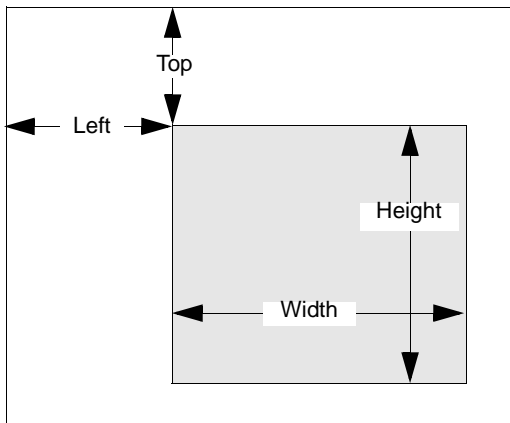

Region of Interest Parameters

### Top (Row Pointer)

*Definition:* Defines the row position of the upper-left starting point of the window.

*Serial Cmd:* <K516, **top**, left, height, width>

*Default:* **0**

*Options:* 0 to 496 (CCD)  
0 to 480 (CMOS)

### Left (Column Pointer)

*Definition:* Defines the column position of the upper-left starting point of the window.

*Serial Cmd:* <K516, top, **left**, height, width>

*Default:* **0**

*Options:* 0 to 656 (CCD)  
0 to 640 (CMOS)

## Height (Row Depth)

*Definition:* Defines the size, in rows, of the window. Maximum value is defined as the maximum row size of image sensor minus the Top value.

*Serial Cmd:* <**K516**,*top*,*left*,**height**,*width*>

*Default:* **0**

*Options:* 0 to 496 (CCD)  
0 to 480 (CMOS)

## Width (Column Width)

*Definition:* Defines the size, in columns, of the window. Maximum value is defined as the maximum column size of Image sensor minus the Left value.

*Serial Cmd:* <**K516**,*top*,*left*,*height*,**width**>

*Default:* **0**

*Options:* 0 to 656 (CCD)  
0 to 640 (CMOS)

# Dynamic Setup

You can visually determine where moving symbols will appear in the FOV during a read cycle by adjusting the delay time before capture.

**Note:** If not already in **Edge** and **Rapid** modes, the reader will automatically change to those settings when you open the **Dynamic** window.

1. First set the **Captures #**.
2. Next set the **Number of Captures** and **Number of Symbols** that will be read during the read cycle.
3. Set **Delay** time.

If **Number of Captures** is set to **1**, **Delay** time will be the time between the start of a read cycle and the first capture. If set to any number other than **1**, **Delay** time will be the time between the capture set in **Capture #** and the previous capture.

4. Start the moving application and trigger the read cycle.
5. Adjust the **Delay** setting so that the symbol appears near the center of the window.

For example, if **Number of Symbols** is set to **3** and **Capture #** is set to **1**, the **Delay** time will represent the time before the capture. You can change the number by manually sliding the bar tab back and forth or by typing in a number. Numbers in the **Delay** box are rounded to the nearest value in  $\pm 32\mu\text{s}$  increments.

**Note:** If a read cycle trigger occurs before **ESP** has finished processing/receiving an image from the previous read cycle, the trigger will be ignored. This is done to ensure that **ESP** remains in sync with the reader.

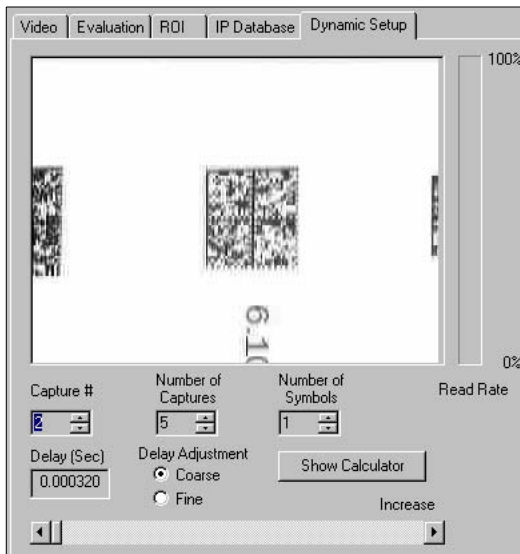

## **Calculator**

The Calculator is a convenient tool to help visualize and control the spacing of rapid captures. To use the calculator:

1. From the **Dynamic** window, click the **Show Calculator**.

The Calculator window will pop up with the number of captures shown.

2. Enter the line speed under **Transport Speed**.
3. Select **Lens Type** and **Focal Distance**.

4. You can now enter in delays individually before each capture. (**Delay 1** is the same at the **Delay (Sec)** entered in the Dynamic window.)

You can change the delay before the first capture by moving the sliding horizon bar in the **Dynamic** window and clicking **Show Calculator**.

You can also click on any of the delays (including the first) and directly type in the delay time into any of the delays.

The spacing of the captures (C1 through Cn) represents the number of captures that will fall within the reader's FOV during the captures taken in the rapid capture burst.

## CCD Image Sensor

Configures the operation of the CCD image sensor. Typically most of these parameters will be adjusted during the calibration process and do not need to be modified directly by the user.

Note that the Quadrus EZ may have one of two types of image sensors, CCD or CMOS. Even though some of the parameters between the sensors are similar, they are configured independently with different configuration commands. Therefore, the user needs to know which sensor type is installed in the Quadrus EZ. To find the sensor type, send **<op,10>**. The reader will reply with a status report that includes the message: "SENSOR=CCD" or "SENSOR=CMOS."

### Gain (CCD)

- Usage:* Can be used to adjust pixel gray scale values for readability.
- Definition:* The CCD has a programmable gain amplifier (PGA) that controls the amount of gain applied to the pixel gray scale value, prior to output. This value can vary depending on lighting conditions and shutter speed.
- Serial Cmd:* **<K540,shutter speed,gain>**
- Default:* **550**
- Options:* 0 to 1023

### Shutter Speed (CCD)

- Usage:* Faster shutter speeds reduce blurring in faster applications.  
Slower shutter speeds are useful in slower and lower contrast applications.
- Definition:* Shutter speed is the time, in fractions of a second, that the CCD sensor is exposed to light.
- Serial Cmd:* **<K540,shutter speed,gain>**
- Default:* **1000** (1/1000 second)
- Options:* 50 to 50,000

**Note for CCD readers:** When **Live** video mode is active, in order to synchronize with the video format, a shutter time of 1/1000 is the lowest shutter speed setting that can be applied to the camera settings. Slower shutter speeds will disable the video output.

# CMOS Image Sensor

Configures the operation of the CMOS image sensor. Typically these parameters will be obtained during the calibration process, and do not need to be modified directly by the user.

Note that the Quadrus EZ has one of two types of image sensors, CCD or CMOS. Even though some of the parameters between the sensors are similar, they are configured independently with different configuration commands. Therefore, the user needs to know which sensor type is installed in the Quadrus EZ. To find the sensor type, send **<op,10>**. The reader will reply with a status report that includes the message: "SENSOR=CCD" or "SENSOR=CMOS."

CMOS Image Sensor	
Shutter Speed	250
Gain	10
Contrast	2
Offset	0

## Shutter Speed (CMOS)

- Usage:** Faster shutter speeds reduce blurring in faster applications.  
Slower shutter speeds are useful in slower and lower contrast applications.
- Definition:** Shutter speed is the time, in fractions of a second, that the CMOS sensor is exposed to light. For very short shutter times, additional external lighting may be required.
- Serial Cmd:** **<K541,shutter speed,gain,contrast,offset>**
- Default:** **250** (1/250 second)
- Options:** 50 to 50,000

## Gain (CMOS)

- Usage:** Can be used to adjust pixel gray scale values for readability.
- Definition:** Controls the amount of energy applied to the pixel gray scale values, prior to output. This value can vary depending on lighting conditions and shutter speed.
- Serial Cmd:** **<K541,shutter speed,gain,contrast,offset>**
- Default:** **10**
- Options:** 0 to 63

## Contrast (CMOS)

- Usage:* Too low a contrast setting can cause an image to be “washed” out.  
Too high a setting can cause some gray areas to go white.
- Definition:* Controls the distinction between white and dark elements.
- Serial Cmd:* <K541, shutter speed, gain, **contrast**, offset>
- Default:* **2**
- Options:* 0 to 7

## Offset (CMOS)

- Usage:* Useful to distinguish a symbol from the background.
- Definition:* Allows you to change the Offset value. This adjustment is usually made experimentally during setup.
- Serial Cmd:* <K541, shutter speed, gain, contrast, **offset**>
- Default:* **0**
- Options:* 0 to 63



---

# Illumination Source

- Usage:* Allows different intensities of light or external lighting to be applied to a variety of symbols in various environments.
- Definition:* Configures the illumination source. When external lighting is configured, then the on-board illumination LEDs are disabled. Internal illumination is comprised of two sets of LEDs. This allows for three levels of illumination intensity and patterns.
- Serial Cmd:* **<K535,illumination source>**
- Default:* **Internal, both inner and outer LED rings**
- Options:*
- 0 = External, internal lighting disabled
  - 1 = Internal, both inner and outer LED ring
  - 2 = Internal, inner LED ring only
  - 3 = Internal, outer LED ring only

# Thresholding

## Threshold Mode

**Usage:** **Fixed** works better when decode time must be as short as possible and the reflectance and illumination of the symbol area is uniform and unchanging. Otherwise **Adaptive** is the preferred mode.

This value switches the image processing threshold mode between the **Adaptive** and **Fixed** modes.

**Definition:** An adaptive routine sets the light/dark threshold from data acquired from the current read. A fixed mode applies the same gray scale threshold value to each and every symbol.

Generally, **Adaptive** gives better results than **Fixed**.

Unlike **Adaptive**, **Fixed** applies the same value consistently to each and every symbol.

**Serial Cmd:** <K512,threshold mode,threshold value>

**Default:** **Adaptive**

**Options:** 0 = Adaptive      1 = Fixed

## Threshold Value

**Usage:** A higher value will increase the threshold for distinguishing between light and dark elements.

Determines how the reader will distinguish light from dark pixels.

**Definition:** This value is used for the Fixed Mode only. When the Adaptive Mode is set, this value is ignored.

**Serial Cmd:** <K512,threshold mode,threshold value>

**Default:** **128**

**Options:** 0 to 255

# Image Processing Settings

**Image Processing Settings** control the amount of processing that occurs before an image is displayed.

Image Processing Settings	
Processing Mode	Standard
Multiple Symbols in Fast Linear Mode	0
Image Processing Timeout	0
Hollow Mode	Disabled

## Processing Mode

**Standard** mode should decode over 90% of symbologies.

**Mode 1** is useful for QR code and narrow-margined symbols.

**Mode 2** and **Mode 3** are intended for multiple symbols in the same FOV.

**Mode 3** can also be used for narrow-margined symbols and large QR code with large position detection patterns.

**Mode 4** applies to Data Matrix only and is used in rare cases to improve readability.

**Mode 5** is for used to increase decode rates of linear symbols that are presented in the picket fence direction.

Processing modes can affect processing time and image quality.

*Definition:* Typically **Standard** mode should perform quickly and adequately in most cases. Modes 1, 2, and 3 may slow down processing slightly but might be recommended in certain usages.

*Serial Cmd:* <**K513,processing mode**>

*Default:* **Standard**

*Options:* 0 = Standard      1 = Mode 1      2 = Mode 2  
3 = Mode 3      4 = Mode 4      5 = Fast Linear Mode

## Multiple Symbols in Fast Linear Mode

Applies to For **Fast Linear** processing mode only.

*Usage:* Used to process more than one symbol appearing in the FOV

*Definition:* Searches for one or two symbols in the FOV, as defined.

*Serial Cmd:* <**K518,number of symbols**>

*Default:* **0**

*Options:* 0 to 2

## Image Processing Timeout

**Caution: Image Processing Timeout**, if not properly set, can have a negative impact on good reads. If you do not see improvements after experimenting with various timeouts, re-apply the default **0** value.

**Usage:** Useful in higher speed applications where image processing time is long enough that not all captures have an opportunity to be processed.

**Definition:** Specifies the maximum amount of time to process a captured image. When the timeout expires, the image processing is aborted. This timeout works in both **Rapid Capture** and **Continuous Capture** modes, as well as with the IP database.

**Serial Cmd:** **<K245,image processing timeout>**

**Default:** **0**

**Options:** 0 to 65535 (in 1mS increments)

### Notes:

1. If set to 0, then there is no timeout.
2. The timeout period does not include capture time.
3. If a timeout occurs during processing, the image will be recorded as a NOREAD. For this reason a longer timeout might be tried to remove uncertainty.

# Hollow Mode

- Usage:* Used to decode hollow data matrices.
- Definition:* When set to **Enabled**, will decode hollow data matrices but not decode solid data matrices. When set to **Disabled**, will decode normal solid data matrices.
- Serial Cmd:* <**K517,hollow status**>
- Default:* **Disabled**
- Options:* 0 = Disabled      1 = Enabled

The image below is an example of a hollow mode outline matrix.

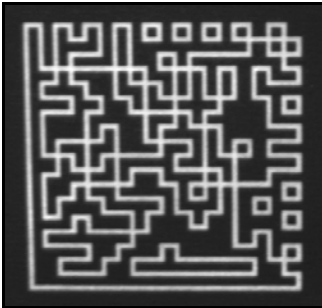

## Mirrored Image

- Usage:* When the reader is getting a mirrored image, for example with an attached right-angled mirror, enable this setting.
- Definition:* When enabled, outputs a mirrored image of the symbol.
- Serial Cmd:* **<K514,mirrored image>**
- Default:* **Regular Image**
- Options:* 0 = Regular Image                      1 = Mirrored Image

## Other Camera Parameters

The following commands are listed in other menus but included in the Camera menu as a convenience:

**For:**

└─ Narrow Margin Status	Disabled
└─ Symbology ID Status	Disabled
└─ Background Color	White

See Chapter 4, [Symbologies](#).

**For:**

└─ Multisymbol	
└─ Number of Symbols	1
└─ Multisymbol Separator	,

See Chapter 4, [Symbologies](#).

**For:**

└─ Capture Mode	Rapid Capture
└─ Number of Captures	1
└─ Capture Time	
└─ Time Before 1st Capture	0
└─ Time Between Captures...	0
└─ Time Between Captures...	0
└─ Time Between Captures...	0
└─ Time Between Captures...	0
└─ Time Between Captures...	0
└─ Time Between Captures...	0
└─ Time Between Captures...	0
└─ Time Between Captures...	0

See Chapter 3, [Read Cycle](#).

---

*Other Camera Parameters*



# 10 IP Database

## Contents

IP Database by ESP.....	10-2
IP Database Serial Commands .....	10-3
Overview of IP Database.....	10-4
Operation of IP Database.....	10-4
IP Database Window.....	10-6
Number of Active Database Settings.....	10-7
CCD Image Sensor Database.....	10-8
CMOS Image Sensor .....	10-10
Save Current Settings to Database.....	10-13
Load Current Settings from Database.....	10-13
Request Database Settings.....	10-14
Request All Database Settings.....	10-14

An image processing database allows the user to save up to 10 multiple camera/image processing settings.

**Note:** The characters **NULL** <> and , can only be entered through embedded menus, not through **ESP** or serial commands.

# IP Database by ESP



Camera

Click this button to bring up the **Read Cycle/Triggering** menu.

You will see these tabs to the left of the **Camera Settings** tree control. Click on the **IP Database** tab.

Video | Evaluation | ROI | **IP Database** | Dynamic Setup

Index	Shutter Speed	Gain	Processing Mode	Narrow Margins	Background Color	Threshold Mode	Fixed Threshold Value
Current	1000	550	Reference	Disabled	White	Adaptive	128
1	1000	550	Standard	Disabled	White	Adaptive	0
2	1000	550	Standard	Disabled	White	Adaptive	0
3	1000	550	Standard	Disabled	White	Adaptive	0
4	1000	550	Standard	Disabled	White	Adaptive	0
5	1000	550	Standard	Disabled	White	Adaptive	0
6	1000	550	Standard	Disabled	White	Adaptive	0
7	1000	550	Standard	Disabled	White	Adaptive	0
8	1000	550	Standard	Disabled	White	Adaptive	0
9	1000	550	Standard	Disabled	White	Adaptive	0

Calibrate

5 Number of Active Indexes Load Index To Current

Receive Send Settings Load Current To Index

## IP Database Serial Commands

IP Database Size	< <b>K252</b> ,number of active database settings>
CCD Database	< <b>K250</b> ,CCD database index,shutter speed,gain,threshold mode, fixed threshold value,processing mode,background color,narrow margins>
CMOS Database	< <b>K251</b> ,CMOS database index,shutter speed,gain,contrast,offset,threshold mode,fixed threshold value,processing mode,background color,narrow margins>
Save Current Settings to Database— CCD	< <b>K250+</b> ,database index>
Save Current Settings to Database— CMOS	< <b>K251+</b> ,database index>
Load Current Settings to Database— CCD	< <b>K250-</b> ,database index>
Request Database Settings— CCD	< <b>K250?</b> ,database index >
Request Database Settings— CMOS	< <b>K251?</b> ,database index >
Request all Database Settings— CCD	< <b>K250?</b> >
Load Current Settings to Database— CMOS	< <b>K251-</b> ,database index>
Request all Database Settings— CMOS	< <b>K251?</b> >

## Overview of IP Database

*Usage:* Useful in applications in which a variety of symbol conditions require different settings that can be applied in real time.

*Definition:* Up to 10 multiple camera/image processing settings can be saved to a database and be applied sequentially during operations.

## Operation of IP Database

Once **IP Database** is enabled, the reader's current settings for **Shutter Speed, Gain, Threshold Mode, Fixed Threshold Value, Processing Mode, Background Color,** and **Narrow Margins** will no longer impact reader operation. For those parameters, only settings that are in the database will be used for image capture and processing.

When in **IP Database** mode and at the end of a read cycle or a calibration routine, if a decode has occurred, the settings that were applied to that decode will move to the top of the database. For example if a decode occurred using the 4th configuration index, it would be moved to index #1 and the configurations preceding index 4 would be moved down one slot as illustrated below:

Index	Moved to
1	2
2	3
3	4
4	1
5	5

When changing database settings, it is not always necessary to re-capture an image. If the new configuration changes a camera parameter, then it is necessary to re-capture an image. The capture mode selected (**Rapid** or **Continuous**) also has an impact on whether a new image needs to be captured. The following summarizes the operation of the reader for the two different capture modes when the IP database is enabled.

## ***Rapid Capture Mode***

In **Rapid Capture** mode, a capture can occur during image processing. For this reason it is not possible to modify any image processing or decode parameters in this mode and only camera configuration settings in the database will take effect. The following IP database settings are not applied while in **Rapid Capture** mode: **Threshold mode, Fixed Threshold Value, Processing Mode, Background Color** and **Narrow Margins**.

In **Rapid Capture** mode, when a reader enters the read cycle, it uses index 0 settings of the IP database for the 1st image capture. For each successive capture the IP database index is incremented and the new settings are applied to the new capture. A new capture is acquired for each database configuration. When the last active database index is filled and there are more captures to take, the index will start back at 0.

## ***Continuous Capture Mode***

When **IP database** is enabled (whenever **Database Size** is not equal to 0), **Continuous Capture** no longer works in a double-buffered format. When the read cycle begins, the reader enters uses index 0 settings of the IP database for the 1st image capture. The reader will capture and decode the image, and increment the database index and apply the new configuration. If the new configuration does not change camera settings, then a new image is not acquired and the reader will try to decode the current captured image with the new image processing settings. If the camera settings have changed from the previous settings, then a new capture is required. When the end of the active database configuration has been reached, the index will start back at 0.

# IP Database Window

In **ESP** when you click on the **IP Database** tab you will see the following:

The screenshot shows the IP Database window with the following components and annotations:

- Table:** A table with columns: Index, Shutter..., Gain, Process..., Narrow..., Backgrou..., Threshold..., and Fixed Thres... The rows are labeled Current, 1, 2, 3, 4, 5, 6, 7, 8, 9, and 10.
- Annotations:**
  - Changes to settings in the **Current** row will be reflected in **ESP** settings (points to the Current row).
  - Click once to select the index row; Double-click on any cell to make specific changes (points to the index column).
  - Setting to any number other than zero will enable (same as <K252>) (points to the Number of Active Database Settings spinner).
  - Copies saved db settings to the window (points to the Receive button).
  - Saves selected index settings to db. (points to the Send Settings button).
  - Copies the selected index settings to **Current** index (points to the Load To Current button).
  - Starts a calibration routine (points to the Calibrate button).

Index	Shutter...	Gain	Process...	Narrow...	Backgrou...	Threshold...	Fixed Thres...
Current	1000	812	Standard	Disabled	White	Adaptive	128
1	1000	812	Standard	Disabled	White	Adaptive	128
2	1000	706	Standard	Disabled	White	Adaptive	128
3	0	0	Standard	Disabled	White	Adaptive	0
4	0	0	Standard	Disabled	White	Adaptive	0
5	0	0	Standard	Disabled	White	Adaptive	0
6	0	0	Standard	Disabled	White	Adaptive	0
7	0	0	Standard	Disabled	White	Adaptive	0
8	0	0	Standard	Disabled	White	Adaptive	0
9	0	0	Standard	Disabled	White	Adaptive	0
10	0	0	Standard	Disabled	White	Adaptive	0

From **ESP**, you enable **IP Database** by setting **Number of Active Database Settings** to any number other than zero, the number chosen will cause the same number of rows in the database above to turn blue.

You can make changes to any setting in any row simply by double-clicking and changing the resulting popup dialog.

You can change current settings in **ESP** by making changes in the **Current** row of the database or by making changes in the tree commands to the left of the database.

## Number of Active Database Settings

*Usage:* It's important to remember that **IP Database Size** must be set for the number of indices you are planning to define for your database.

*Definition:* This determines the number of active database indices. Whenever the number of active database indices is something other than 0, IP database is enabled.

In the IP Database tab, enter the number of database settings.

*ESP:*

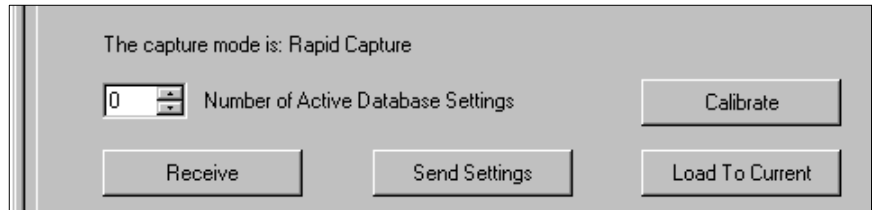

The capture mode is: Rapid Capture

0 Number of Active Database Settings Calibrate

Receive Send Settings Load To Current

*Serial Cmd:* <**K252**,number of active database settings>

*Default:* **0**

*Options:* 1 to 10

# CCD Image Sensor Database

The database indexes (arrays) of camera/image processing settings that are applied when one or more indexes are made active in **IP Database Size**.

**Note:** The following commands apply to the CCD reader only.

## CCD Database Index

**Definition:** Defines the specific database index (1 to 10) of settings that will be applied during operations. Each index (1 to 10) will have its own settings, for example **<K250,1...>**, **<K250,2...>**, etc.

**Serial Cmd:** **<K250, CCD database index, shutter speed, gain, threshold mode, threshold value, processing mode, background color, narrow margins>**

**Default:** **0**

**Options:** 1 to 10

## Gain

**Serial Cmd:** **<K250, CCD database index, shutter speed, gain, threshold mode, threshold value, processing mode, background color, narrow margins>**

**Default:** **0**

**Options:** 0 to 1023

## Shutter Speed

**Serial Cmd:** **<K250, CCD database index, shutter speed, gain, threshold mode, threshold value, processing mode, background color, narrow margins>**

**Default:** **0**

**Options:** 50 to 50,000

## Threshold Mode

**Serial Cmd:** **<K250, CCD database index, shutter speed, gain, threshold mode, threshold value, processing mode, background color, narrow margins>**

**Default:** **0**

**Options:** 0 = Adaptive      1 = Fixed



## Threshold Value

Serial Cmd: <**K250**, CCD database index, shutter speed, gain, threshold mode, **threshold value**, processing mode, background color, narrow margins>

Default: **0**

Options: 0 to 255

## Processing Mode

Serial Cmd: <**K250**, CCD database index, shutter speed, gain, threshold mode, threshold value, **processing mode**, background color, narrow margins>

Default: **Standard**

Options: 0 = Standard      1 = Mode 1      2 = Mode 2  
3 = Mode 3      4 = Mode 4      5 = Fast Linear Mode

## Background Color

Serial Cmd: <**K250**, CCD database index, shutter speed, gain, threshold mode, threshold value, processing mode, **background color**, narrow margins>

Default: **White**

Options: 0 = White      1 = Black

## Narrow Margin Status

Serial Cmd: <**K250**, CCD database index, shutter speed, gain, threshold mode, threshold value, processing mode, background color, **narrow margins**>

Default: **Disabled**

Options: 0 = Disabled      1 = Enabled

# CMOS Image Sensor

The database indexes (arrays) of camera/image processing settings that are applied when one or more indexes are made active in **IP Database Size**.

**Note:** The following commands apply to the CMOS reader only.

## CMOS Database Index

**Definition:** Defines the specific database index (1 to 10) of settings that will be applied during operations. Each index (1 to 10) will have its own settings, for example **<K251,1...>**, **<K251,2...>**, etc.

**Serial Cmd:** **<K251, CMOS database index, shutter speed, gain, contrast, offset, threshold mode, threshold value, processing mode, background color, narrow margins>**

**Default:** **0**

**Options:** 1 to 10

## Shutter Speed

**Serial Cmd:** **<K251, CMOS database index, shutter speed, gain, contrast, offset, threshold mode, threshold value, processing mode, background color, narrow margins>**

**Default:** **0**

**Options:** 50 to 50,000

## Gain

**Serial Cmd:** **<K251, CMOS database index, shutter speed, gain, contrast, offset, threshold mode, threshold value, processing mode, background color, narrow margins>**

**Default:** **0**

**Options:** 0 to 63

## Contrast

Serial Cmd: <**K251**, CMOS database index, shutter speed, gain, **contrast**, offset, threshold mode, threshold value, processing mode, background color, narrow margins>

Default: **0**

Options: 0 to 7

## Offset

Serial Cmd: <**K251**, CMOS database index, shutter speed, gain, contrast, **offset**, threshold mode, threshold value, processing mode, background color, narrow margins>

Default: **0**

Options: 0 to 63

## Threshold Mode

Serial Cmd: <**K251**, CMOS database index, shutter speed, gain, contrast, offset, **threshold mode**, threshold value, processing mode, background color, narrow margins>

Default: **Adaptive**

Options: 0 = Adaptive  
1 = Fixed

## Threshold Value

Serial Cmd: <**K251**, CMOS database index, shutter speed, gain, contrast, offset, threshold mode, **threshold value**, processing mode, background color, narrow margins>

Default: **0**

Options: 0 to 255

## Processing Mode

Serial Cmd: <**K251**, CMOS database index, shutter speed, gain, contrast, offset, threshold mode, threshold value, **processing mode**, background color, narrow margins>

Default: **Standard**

Options: 0 = Standard      1 = Mode 1      2 = Mode 2  
3 = Mode 3      4 = Mode 4      5 = Fast Linear Mode

## **Background Color**

Serial Cmd: <**K251**, CMOS database index, shutter speed, gain, contrast, offset, threshold mode, threshold value, processing mode, **background color**, narrow margins>

Default: **White**

Options: 0 = White            1 = Black

## **Narrow Margins**

Serial Cmd: <**K251**, CMOS database index, shutter speed, gain, contrast, offset, threshold mode, threshold value, processing mode, background color, **narrow margins**>

Default: **Disabled**

Options: 0 = Disabled        1 = Enabled

## Save Current Settings to Database

Saves settings currently enabled to the designated database index.

### **CCD**

Serial Cmd: <**K250+**,database index>

### **CMOS**

Serial Cmd: <**K251+**,database index>

## Load Current Settings from Database

Loads selected database index settings into current reader settings.

### **CCD**

Serial Cmd: <**K250-**,database index>

### **CMOS**

Serial Cmd: <**K251-**,database index>

Example: <**K251-,5**> loads settings from database index # 5.

## **Request Database Settings**

Returns settings for selected database index.

### **CCD**

*Serial Cmd:* <K250?,database index>

### **CMOS**

*Serial Cmd:* <K251?,database index>

## **Request All Database Settings**

Returns settings for the entire database.

### **CCD**

*Serial Cmd:* <K250?>

### **CMOS**

*Serial Cmd:* <K251?>

# 11 Terminal

## Contents

Terminal Window .....	11-2
Find Function .....	11-3
Macros .....	11-4
Terminal Window Menus.....	11-5

This section describes the **Terminal** window and macro functions.

**Note:** The characters **NULL**, **<**, **>**, and **,** can only be entered through embedded menus, not through **ESP** or serial commands.

**Note:** You can learn the current setting of any parameter by inserting a question mark after the number, as in **<K100?>**. To see all “**K**” commands, send **<K?>**.

# Terminal Window

To use **ESP's Terminal**, click on the **Terminal** button:



You will see this window:

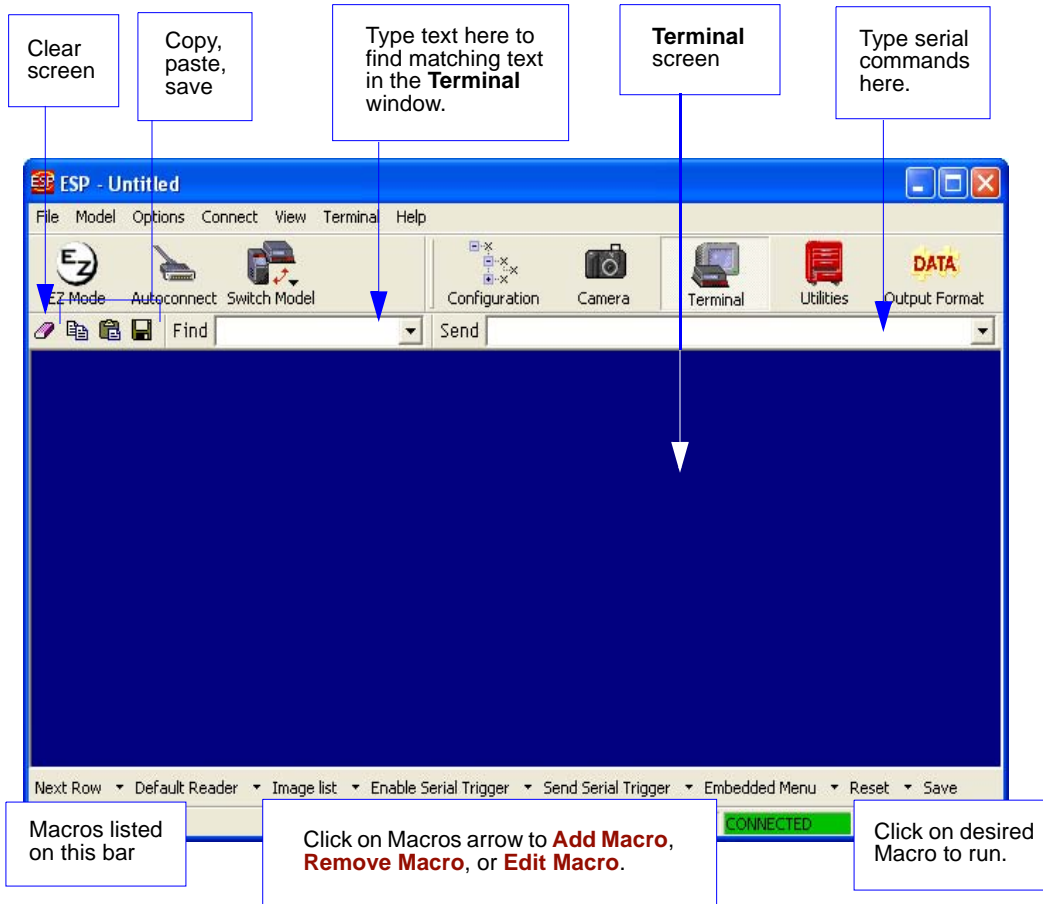

The **Terminal** screen allows you to send serial commands to the reader by using Macros, by copying and pasting, or by typing commands in the “Send” text field.

The **Terminal** screen also displays symbol data or information from the reader.

You can also right click on the **Terminal** screen to bring up a menu of further options.



## Find Function

The **Find** box allows you to enter text strings to be searched for in the **Terminal** window. For example, a series of symbols have been read into the **Terminal** view and you want to determine if a particular code starting with “ABC” has been read.

1. Type **ABC** into the **Find** box.



2. Press **Enter**.  
The first instance of **ABC** will be highlighted in the **Terminal** window.
3. Press the **F3** key to search again for the next instance of **ABC**.
4. Press **Shift-F3** to search for the previous instance of **ABC**.

# Macros

Macros can be stored in a macro selection bar, edited in a separate window, and executed by clicking on the macro name.

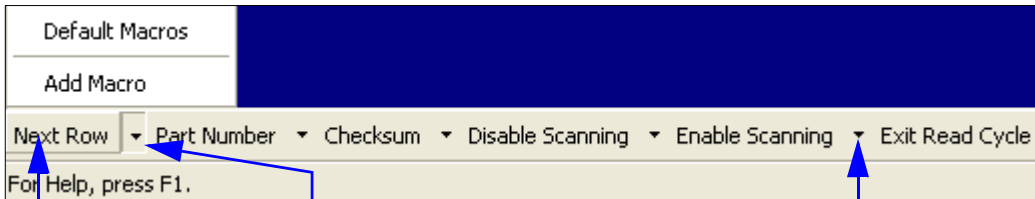

Click on **Next Row** to see the next row of macros

Click on the first arrow here to see **Add Macro** or **Default Macros**. When you default macros, the entire macros set is restored to their original macro commands.

Click on subsequent arrows to edit macros.

When you click on the macro name, the macro is executed in the **Terminal** window. If this is a command, it is sent to the reader at the same time that it is displayed.

## Editing a Macro

When you click the arrow next to any macro and select **Edit**, the following appears:

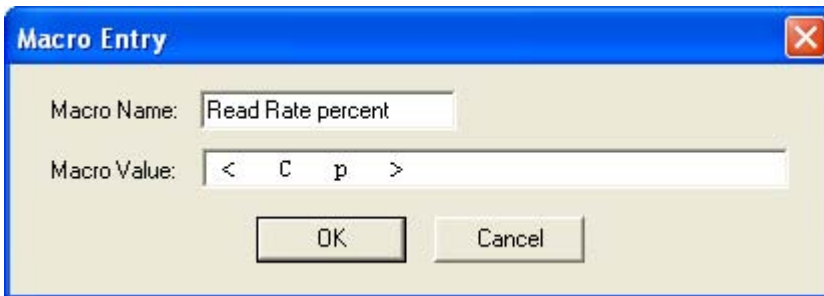

You can edit an existing macro or type in the **Macro Name** text field and define it in the **Macro Value** text field. Click **OK**.

## Terminal Window Menus

Right click on the **Terminal** window to display the following dropdown menu:

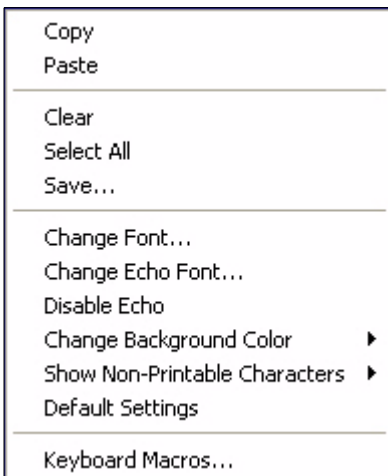

- **Copy** selected text to clipboard.
- **Paste** from **Terminal** or computer text.
- **Clear** all text in **Terminal** window.
- **Select All** text in the **Terminal** window.
- **Save...** brings up a save as dialog box.
- **Change Font...** of data text, brings up a text dialog.
- **Change Echo Font...** to change typed in text or commands.
- **Change Background Color** of **Terminal** window.
- **Default Settings** changes all the above back to default settings.

## Terminal Dropdown Menu

The dropdown **Terminal** menu has **Capture Text** and **Save Current Text** functions, as well as the functions defined above.

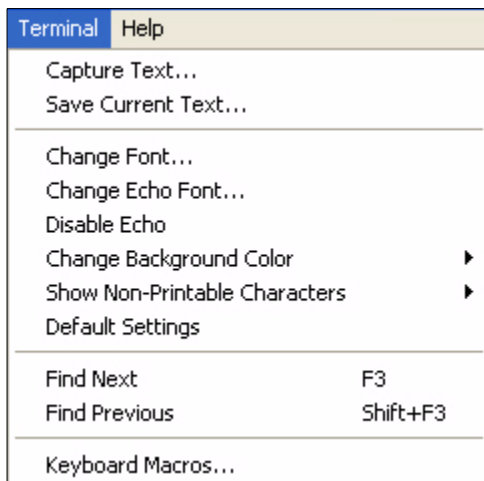

- **Capture** lets you append data in real time to a text file of your choice. While in operation, the text file cannot be opened. You can select **Pause** to interrupt the capture flow or **Stop** to end the flow and open the file.
- **Save Current Text...** saves all text in the **Terminal** window to a text file of your choice.



# 12 Utilities

## Contents

Utilities Serial Commands .....	12-2
Read Rate .....	12-3
Counters .....	12-4
Device Control .....	12-6
Master Database .....	12-7
Firmware.....	12-12
Bar Code Configuration.....	12-16
Defaulting/Saving/Resetting .....	12-17
Reader Status Requests .....	12-19
Other Operational Serial Commands .....	12-20

Utility commands are generally commands that are performed during reader operations to check read rates, determine read rates or perform miscellaneous operations on reader hardware. Serial utility commands are not prefaced with a “K” and a numeric code. Nor do they require an initialization command (<A> and <Z>). They can be entered from within any terminal program or from within **ESP** in the **Terminal** window or the window adjacent to the **Utilities** menu.

**Note:** The characters **NULL** <> and , can only be entered through embedded menus, not through **ESP** or serial commands.

# Utilities Serial Commands

Read Rate	<C>	Enter Decode Rate Test
	<Cp>	Enter Percent Rate Test
	<J>	Exit Decode Rate and Percent Rate Test
Counter Request and Clear	<N>	Noread Counter
	<O>	Noread Counter Reset
	<T>	Trigger Counter
	<U>	Trigger Counter Reset
	<V>	Good Read/Match Counter
	<W>	Good Read/Match Counter Reset
	<X>	Mismatch Counter
	<Y>	Mismatch Counter Reset
Master Database	<E>	Enable Master Symbol
	<F>	Disable Master Symbol
	<G>	Store next Symbol read to Database.
	<M?>	Request Master Symbol Information
	<K231, master symbol number, master symbol data>	Request Master Symbol Information for specific database number.
Part Number Checksum/	<#>	Display Software Code Part Numbers
	<#a>	Display Application Code Part Number
	<#b>	Display Boot Code Part Number
	<#d>	Display DSP Part Number
	<#f>	Display FPGA Part Number
	<!>	Display all 3 Checksums of Flash memory
	<!a>	Display Application Code Checksum
	<!b>	Display Boot Code Checksum
	<!d>	Display DSP Code Checksum
	<!f>	Display FPGA Code Checksum
Device Control	<L1>	Programmable Output 1
	<L2>	Programmable Output 2
	<L3>	Programmable Output 3
Default/Reset/Save	<A>	Reset (does not save for power-on)
	<Ard>	Reset and recall Microscan defaults
	<Arp>	Reset and recall power-on parameters
	<Arc>	Reset and recall customer default parameters
	<Z>	Save current settings for power-on
	<Zc>	Save current settings as customer default parameters
	<Zrd>	Recall Microscan default parameters and save for power-on
	<Zrc>	Recall customer default parameters and save for power-on
Reader Status Commands	<K?>	All Configuration Commands Status
	<?>	Input Status
	<?>	Reader Status
	<?1>	Extended Reader Status

# Read Rate

## By ESP

You can access **Read Rate** from the **Utilities** menu in the **Read Rate** tab.

To see the number of decodes per second, click the **Decodes/sec** radio button and click the **Start** button.

To see the percentage of decodes, click the **Percent** radio button and **Start** button.

To end a read rate routine, click the **Stop** button (same as the **Start** button).

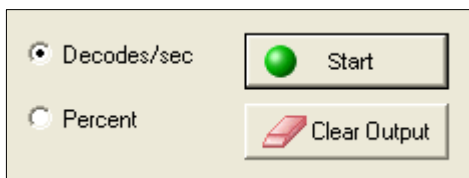

## Read Rate by Serial Command

### Enter Decodes/Second Test

Sending **<C>** instructs the reader to transmit the decodes per second and symbol data (if any). The decode rate can vary dramatically due to the angle and location of the symbol in relation to the field of view. This test is very useful in aligning and positioning the reader during setup.

### Enter Percent Test

Sending **<Cp>** instructs the reader to transmit the percentage of decodes and any read symbol data.

### Enable PDF Information

Sending **<a1>** will cause PDF417 data to be prefaced with information consisting of error correction level (ECC Level **n**), number of rows (**n** Rows), number of columns (**n** Columns), number of informative code words (**n** Info Code Words) and the number of data characters (**n** Data Bytes).

This feature can be disabled by re-sending **<a1>**.

### End Read Rate Test

Sending **<J>** ends both the Percent test and the Decodes/Second test.

## Counters

Counter commands can be a numeric value from 00000 to 65,535. After reaching the maximum numeric limit of 65,535, an error message will be displayed and the counter will automatically roll-over and start counting again at 00000. To obtain the cumulative total of counts after the roll-over has occurred, add 65,536 per each roll-over (the reader does not keep track of the number of roll-overs) to the current count.

**Note:** All counter values will be lost if power is recycled to the reader or the reader receives a reset or save command.

### By ESP

You can access **Counters** from the **Utilities** menu.

Click the **Request** button to display the appropriate count or **Clear** to set counter to zero.

The screenshot shows a graphical user interface for the Counters utility. At the top, there are two large buttons: "Request All" and "Clear All". Below these, there are four rows of controls, each corresponding to a different counter type. Each row contains two buttons: "Request" and "Clear", followed by a text label and an input field. The rows are: 1) "Request", "Clear", "Trigger:", and an empty input field; 2) "Request", "Clear", "Good Read:", and an empty input field; 3) "Request", "Clear", "Noread:", and an empty input field; 4) "Request", "Clear", "Mismatch:", and an empty input field.

### Counters by Serial Command

#### Noread Counter

Sending **<N>** displays the total number of noreads that have occurred since the last reset.

#### Noread Counter Reset

Sending **<O>** sets Noread Counter to 00000.

#### Trigger Counter

Sending **<T>** displays the total number of triggers since the last reset.

#### Trigger Counter Reset

Sending **<U>** sets the trigger counter to 00000.



### **Good Read/Match Counter (or Good Read Counter)**

Sending **<V>** displays the total number of good reads matching the master symbol or, if Master Symbol is not enabled, the number of good reads since the last reset. This counter is always enabled, but will only work as a match count when Master Symbol is enabled. If Master Symbol is not enabled, this counter records the number of good reads. This count can be requested at any time.

### **Good Read/Match Counter Reset**

Sending **<W>** sets the Match Counter to 00000.

### **Mismatch Counter**

Sending **<X>** displays the number of decoded symbols since the last reset that do not match the master symbol.

### **Mismatch Counter Reset**

Sending **<Y>** sets the Mismatch Counter to zero.

# Device Control

## By ESP

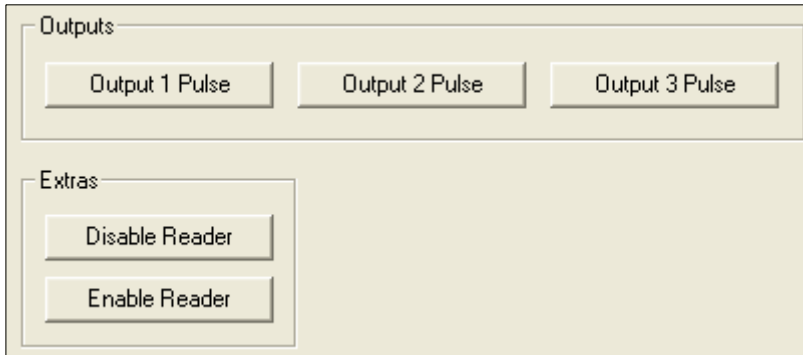

## Device Control By Serial Command

### Output #1 Pulse

Sending **<L1>** pulses activates the link between Output 1(+) and Output 1(-) of the host connector (regardless of Master Symbol or Output 1 status).

### Output #2 Pulse

Sending **<L2>** pulses activates the link between Output 2(+) and Output 2(-) of the host connector (regardless of Master Symbol or Output 2 status).

### Output #3 Pulse

Sending **<L3>** activates the link between Output 3(+) and Output 3(-) of the host connector (regardless of Master Symbol or Output 3 status).

### Disable Reader

Sending **<I>** will turn the reader OFF, end the current read cycle and not allow the reader to enter a read cycle until turned ON. This feature is useful during extended periods of time when no symbols are being scanned or the reader is being configured. Disabling the reader will not affect any downloaded commands to the reader.

### Enable Reader

Sending **<H>** will turn the reader ON and allow it to enter read cycles.

# Master Database

**Important:** **Master Database** is used only for comparing entire symbols, when **Sequential** and **Wild Card** are NOT enabled, and **Start Position** is equal to **0**.

## Master Database Overview

**Usage:** Used where more than one master symbol is required, as in a **Multisymbol** setup, for matching and other matchcode operations.

**Definition:** Allows you to define up to 10 master symbols as the master symbol database, which can be entered by keyboard, scanned in, displayed, or deleted by serial or **ESP** commands.

1. Click the **Master Database** tab.
2. Set the **Master Symbol Database Size**.
3. Select database index you want to enter the master symbol.
4. Do one of the following to enter master symbol data.
  - a) **Double-click** the index row to type data directly into index
  - b) Click the **Read Symbol into Selected Index** to enter the next decoded symbol.

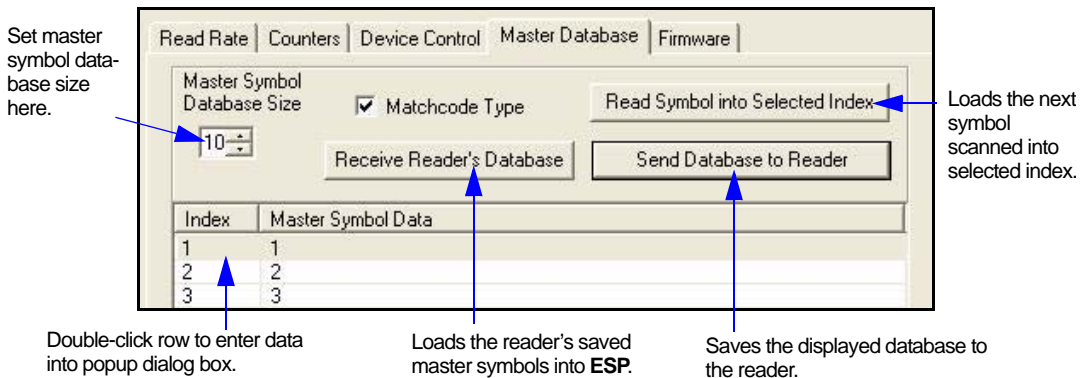

Master Database

**Important:** **Master Symbol Database** is used only for comparing entire symbols, when **Sequential** and **Wild Card** are NOT enabled, and **Start Position** is equal to **0**.

## Master Symbol Database Size

**Definition:** **Number of Master Symbols** allows you to select 1 to 10 master symbols for the master symbol database.

**Serial Cmd:** **<K231, master symbol database size>**

**Note:** You must follow this command with a save command **<A>** or **<Z>**.

**Default:** **1**

**Options:** 1 to 10

Use arrows to set Master Symbol Database Size.

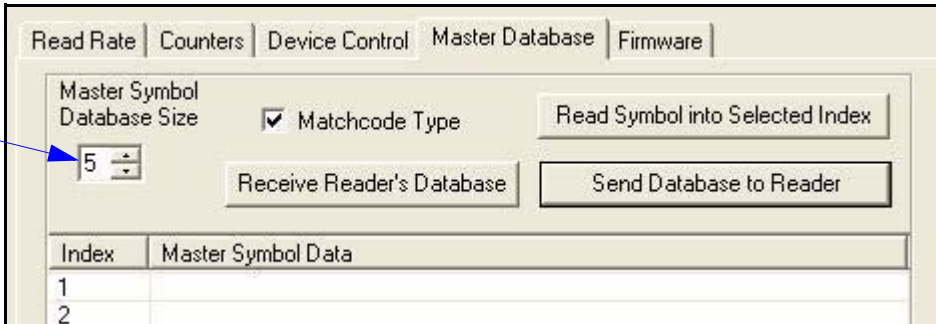

**Caution:** Since the total number of characters available for the master symbol data base is **2710**, changes to the **Master Symbol Data Base Size** will re-allocate the number of characters available for each master symbol and could cause existing master symbols to be deleted (except master symbol #1 unless it also exceeds the size limitation).

The table below specifies the maximum number of characters available to each symbol according to the number of master symbols defined, from 1 through 10.

Maximum Characters for Master Symbol

Master Symbol Number	Maximum Characters	Master Symbol Number	Maximum Characters
#1	2710	#6	451
#2	1355	#7	387
#3	903	#8	338
#4	677	#9	301
#5	542	#10	271

## Enter Master Symbol Data

**Definition:** Allows you to enter master symbol data for a any enabled master symbol index number (1 to 10), provided the total number of characters does not exceed the specified maximum.

**Serial Cmd:** <**K231, master symbol number, master symbol data**>

Enter data for 1 to 10 symbols (any combination of ASCII text up to the specified maximum.

**Options** For example, to enter data for master symbol **9**, after making certain that master symbol database size is enabled for **9** or more symbols, send <**K231,9,data**>.

**Caution:** If no data is entered, the existing data will be deleted.

1. Open the **Utilities** menu.
2. Set the number of master symbols you want to create in **Master Symbol Database Size**.
3. **Double-click** on each symbol number you want to setup and copy or type in your data in the popup dialog and click **OK**.

ESP:

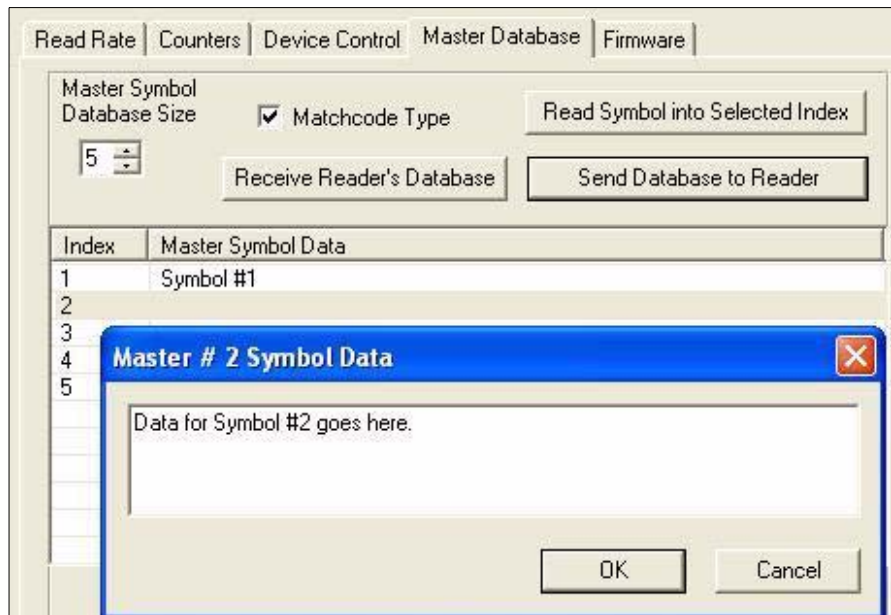

4. When all your data has been enter, click on the button, **Send Database to the Reader**.

## Request Master Symbol Data

**Definition:** Returns master symbol data for any enabled master symbols from 1 to 10. For example, to request master symbol #5, enter **<K231 ?,5>**. The reader transmits master symbol #5 data in brackets in the following format: **<5/ data>**.

If no master symbol data is available, the output will be: **<5/>**.

**Serial Cmd:** **<K231 ?,master symbol number>**

**Caution:** Be sure to add the **?** or you will delete the master symbol.

Returns the number of master symbols if no number is included.

**ESP:**

1. Click the **Utilities** button and the **Master Database** tab.
2. Click on the **Receive Reader's Database** button.

## Request All Master Symbol Data

**<K231 ?>**

**Serial Cmd:** This command will return master symbol data for all symbols enabled (up to 10).

## Read Next Symbol as Master Symbol

**Definition:** After you've set the size in the database, you can order the reader to read the next symbol as the master symbol for any given master symbol number.

**<G master symbol number>**

To store the next symbol read as master symbol #1, send:

**<G>** or **<G1>**.

**Serial Cmd:** To store next symbol read as the master symbol for any other master symbol database number, send:

**<G master symbol number [1-10]>**.

For example, **<G5>** will cause the next symbol read to be entered as master symbol #5.

**ESP:**

In the **Master Database** tab, under the **Output Format** menu

1. Select the master symbol index number in which you want to store the symbol data.
2. Click on **Read Symbol into Selected Index**.

**Caution:** If you've selected an index which has existing data, that data will be copied over by scanned data when you use this command.

## Request New Master Status

- Usage:** Informs the user when a new master symbol is pending and which position it is in.
- Definition:** Returns the position in the master symbol database that will be loaded on the next read.  
<NEWM>
- Serial Cmd:** The reader returns: <NEWM/next master to load>  
Once a symbol has been read and loaded, the status will be cleared and a response will be <NEWM/0>.

## Delete Master Symbol Data

- Definition:** You can directly delete the master symbol data by serial command or **ESP**.
1. Click the **Utilities** button to access the master symbol:
  2. Click the **Master Database** tab and double-click the symbol number you want to delete.
  3. Delete text and Click **OK**.

**ESP:**

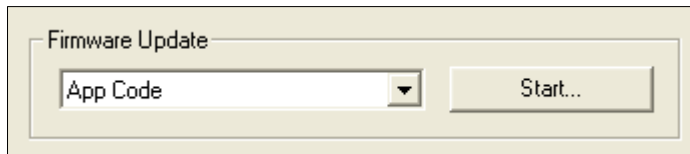

<K231,master symbol number,>

- Serial Cmd:** To delete a master symbol, enter the database number and a comma, but leave the data field empty. For example, to delete master symbol #5, send the following <K231,5,>. The command is entered with a blank master symbol data field which tells the reader to delete the selected master symbol from the database.

# Firmware

## By ESP

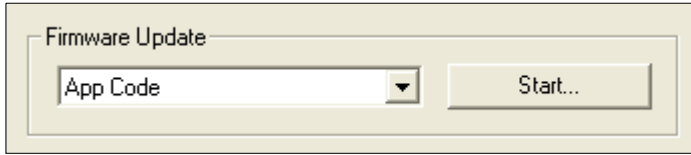

## Firmware Update

Application code versions are specific to your reader. Consult with your sales representative before downloading application code. If needed, an application code will be sent to you in the form of a **\*.mot** file.

To download application code:

1. First make sure the host is connected to your reader.
2. Apply power to the reader.
3. Before updating, you should verify the current firmware.
4. Click in the **Firmware Update** text box and select the file type you want to download. This will open a file locator box.
5. Navigate to the appropriate file (a **\*.mot** file) and open the file.

**Caution:** *Do not interrupt power or disconnect the host cable while download is in progress. Be sure that each download is complete before moving on to the next.*

**Important:** *When updating firmware, be sure that the application code, boot code, DSP code, and FPGA code are versions that are compatible with each other.*



## Firmware Verification

### Request Part Number

You can send a request to the reader for part numbers, checksums, boot code, and application code.

#### By ESP

You can access **Part Numbers** from the **Utilities** menu.

1. Click the **Firmware** tab.
2. From the pull-down selection box to the left of the **Request Part No.**, make your selection.
3. Select the code type to see part number displayed in the box to the right.

The screenshot shows a window titled "Firmware Verification". Inside, there are two rows of controls. The first row consists of a dropdown menu labeled "Boot Code", a button labeled "Request Part No.", and an empty text input field. The second row consists of a dropdown menu labeled "FPGA Code", a button labeled "Request Checksum", and another empty text input field.

#### By Serial Command

Upon sending **<#>** the reader returns:

**<#b/BOOT\_CODE><#a/APP\_CODE><#d/DSP\_CODE><#f/FPGA\_CODE>**.

Upon sending **<#a>** the reader returns: **<#a/APP\_CODE>**.

Upon sending **<#b>** the reader returns: **<#b/BOOT\_CODE>**.

Upon sending **<#d>** the reader returns: **<#d/DSP\_CODE>**

Upon sending **<#f>** the reader returns: **<#f/FPGA\_CODE>**

## Request Checksum

You can send a request to the reader for part numbers, checksums, boot code, and application and code.

Checksums verify a reader's flash memory.

### By ESP

You can access **Checksum** from the **Utilities** menu.

1. Click the **Firmware** tab.
2. From the pull-down selection box to the left of the **Request Checksum**, make your selection.
3. Select the code type to see the checksum displayed in the box to the right.

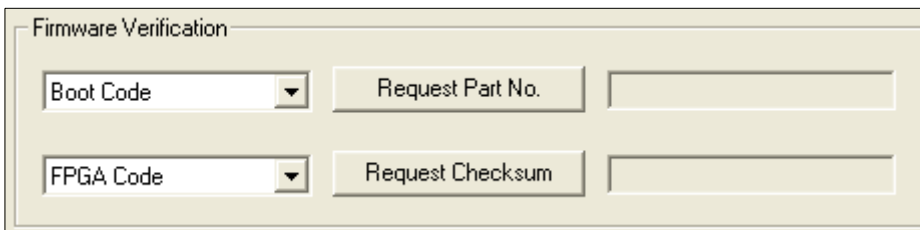

The image shows a software interface titled "Firmware Verification". It contains two rows of controls. The first row has a dropdown menu labeled "Boot Code", a button labeled "Request Part No.", and an empty text input field. The second row has a dropdown menu labeled "FPGA Code", a button labeled "Request Checksum", and an empty text input field.

### By Serial Command

Upon sending **<!>** the reader returns four 4-digit hex numbers that are displayed under **Check Sum** and apply to APP\_CODE, BOOT\_CODE, DSP\_CODE, and FPGA\_CODE.

Upon sending **<!a>** the reader returns a 4-digit hex number that is displayed under **Application Code**.

Upon sending **<!b>** the reader returns a 4-digit hex number that is displayed under **Boot Code**.

Upon sending **<!d>** the reader returns a 4-digit hex number that is displayed under **DSP Code**.

Upon sending **<!f>** the reader returns a 4-digit hex number that is displayed under **FPGA Code**.

## Sensor Type

### Request Sensor Type

*Definition:* Reports the type of image sensor installed in the reader. This is a read-only command. To obtain the image sensor status, send the command as a status request.

#### By ESP

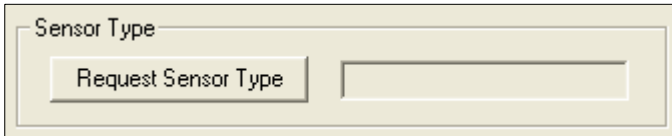

#### By Serial Command

*Serial Cmd:* <op,10>

When you send this command, the Quadrus EZ responds with a long string of status values related to the reader. Within this string you will see either:

**SENSOR=CCD**

or

**SENSOR=CMOS**

# Bar Code Configuration

*Definition:* Bar code configuration is a way of programming the reader by using Data Matrix ECC200 symbols.

*Serial Cmd:* **<BCCFG>**

Bar code configuration can be entered three different ways:

1. By forcing the reader into bar code configuration mode by serial command **<BCCFG>**.
2. By configuring one of the 4 EZ button positions to bar code configuration mode.
3. By reading a Data Matrix symbol with a special code word used by ISO/IEC 16022 to signify reader programming. This can be either in a regular read cycle or in read rate. Reading this symbol in the calibration routine will have no effect.<sup>1</sup>

Once **Bar Code Configuration** mode has been entered, the Data Matrix symbols can be thought of as serial data. You can configure the reader by printing labels in Microscan's serial command format. Commands are processed as if the data were streamed in through the serial port. The reader will acknowledge the symbol with a beep, green flash, and echo the serial data to the host. If the command causes the reader to produce more serial output such as serial verification or counter requests, the data will be routed to the host port.

The Bar code configuration mode can be exited by any reset **<A>** or **<Z>** command as well as a **<J>** or a quick press and release of the EZ button.

The command to exit bar code configuration can be included as part of the bar code, for example, encoding **<K200,4><K220,1><J>** into a Data Matrix symbol. This would configure the reader to serial trigger mode, program a new trigger to end the read cycle, and exit the bar code configuration mode with the **<J>**.

To end all EZ button functions, press the EZ button and quickly release.

---

<sup>1</sup> In normal reading modes, it is required to read a special Data Matrix symbol with a special codeword used by ISO/IEC 16022 to signify reader programming.

# Defaulting/Saving/Resetting

Understanding and controlling your reader's active, saved, and default settings is critical to the operation of your reader.

## Software Reset/Save/Recall Commands

	Function	Serial Cmd	ESP (first, right click in any menu tree) <sup>a</sup>	EZ Button
Resets (not saved for power-on)	Reset	<A>	<b>Save to Reader, Send No Save</b>	No
	Reset and recall Microscan defaults	<Ard>	No	No
	Reset and recall power-on parameters	<Arp>	No	No
	Reset and recall customer default parameters	<Arc>	No	No
Saved for Power-on	Save current settings for power-on	<Z>	<b>Save to Reader, Send and Save</b>	No
	Save current settings as customer default parameters	<Zc>	<b>Save to Reader, Send and Save Customer Defaults<sup>b</sup></b>	No
	Recall Microscan default parameters and save for power-on	<Zrd>	No	No
	Recall customer default parameters and save for power-on	<Zrc>	No	<b>Press and hold while powering on reader</b>

a. When you right click in a menu tree and select **Default Current Menu Settings** or **Default All ESP Settings**, it is important to note that only **ESP** settings are defaulted. To save these defaults to the reader itself, you need to follow up with a **<Z>** or **Save to Reader, Send and Save** command.

b. Only available in **ESP** if enabled under the **Options** pulldown menu.

## Resets

Resets ("**A**" commands) affect only the current settings (active memory) and are not saved for power-on.

## Saved for Power-on

Power-on parameters ("**Z**" commands) are saved to NOVRAM and recalled and loaded into current parameters when power is cycled or the **<Arp>** command is issued.

## Defaults

Defaults are Microscan firmware settings or saved customer settings that can be recalled, either by software or hardware reset.

## **Customer Default Parameters**

Customer default parameters (saved by **<Zc>**) are the same set of parameters as power-on parameters but are saved in a different, isolated section of NOVRAM. This allows a user to essentially create a backup set of parameters that can be recalled in the event that the current parameters or power-on parameters have been accidentally changed or no longer desired.

It is important to note that a hardware default does not affect customer default parameters. For example, a user that has inadvertently changed communication settings and saved them with a **<Z>** command, may not know the correct settings or doesn't have the capability to communicate at those settings. By first doing an EZ button or hardware default to restore the known Microscan defaults, the user can then recall the previously customer saved settings with an **<Arc>** or **<Zrc>** command.

## **Microscan Default Parameters**

Microscan default parameters are contained in the firmware and cannot be changed.

### **Software Defaults**

Microscan default parameters can be recalled (loaded into current settings) with **<Ard>** command or recalled and saved for power-on with the **<Zrd>** command.

### **Hardware Default**

If a software default reset is not possible, it may be necessary to reset the reader by shorting (connecting) specific pins. This procedure has the same effect as the **<Zrd>** software command.

**Important:** For this reset to occur, this command must be executed within 60 seconds after a power-on or a reset.

1. Apply power to the reader.
2. If using an IB-150, locate pins 7 and 11 on the host connector.

**Caution:** Be certain that the correct pins are located. Connecting the wrong pins could cause serious damage to the unit.

3. Momentarily connect these wires (or pins) and listen for a series of short beeps.
4. Within 3 seconds, connect them again. A longer beep should be heard. If not, repeat the process.

### **Default on Power-On**

You can also use the EZ button to default the reader by holding down the EZ button while applying power to the reader, provided that this feature is enabled.

# Reader Status Requests

## <?> Reader Status Byte

The reader responds to a status request <?> with a two character hex value, for example <?/22>. To determine the status:

1. Look up the binary conversion in the hex-to-binary table.

For example, the first **2** in binary would be **0 0 1 0** as read from binary digits 3 through 0; the second **2** the binary digits 7 through 4 which is also **0 0 1 0**.

2. Next, enter your binary values in the “Reader Status” table in the “Binary” column next to the appropriate bit.

*Quadrus EZ Status*

Bit	Binary	Reader Status
0	0	Command error detected
1	1	Command received
2	0	Communication error detected
3	0	Flash sector unprotect failure
4	0	Host/Aux port buffer overflow
5	1	Reader is in a read cycle
6	0	Software Watch dog reset
7	0	Hardware Watch dog reset

3. Under “Binary,” interpret **1s** as true and the **0s** as not true. For example, bit 1 has a **1** in the “Binary” column, indicating “Command Received.” Bit 5 is also a **1** indicating that the “Reader is in a read cycle.”

## <?1 > Extended Status

The reader responds to an extended status request <?1> with several fields.

These represent, in order: the status byte as discussed above, the boot part number, application part number, FPGA part number, Flash checksum, and Flash parameter checksum.

## <K?> Configuration Command Status

Returns the current status of all configuration commands.

*Hex Value to Binary Conversion*

Hex Value	Binary Bit Digits			
	7	6	5	4
	3	2	1	0
0	0	0	0	0
1	0	0	0	1
2	0	0	1	0
3	0	0	1	1
4	0	1	0	0
5	0	1	0	1
6	0	1	1	0
7	0	1	1	1
8	1	0	0	0
9	1	0	0	1
A	1	0	1	0
B	1	0	1	1
C	1	1	0	0
D	1	1	0	1
E	1	1	1	0
F	1	1	1	1

## Other Operational Serial Commands

The following serial utility commands can be entered from the **ESP Terminal** window or a PLC:

### ***Y-Modem Upload Image***

**<uy,filename>**

### ***Calibration***

**<op,6,1>** Calibrate to optimize Contrast and Readability

**<op,6,0>** End Calibration

**<op,7>** Determine Calibration Progress

**<@DPM>** Calibrate to optimize DPM (Direct Part Marking) features

### ***Image Library Request***

Manages files and directories in a selected directory.

**<op,9,source>**

File Source	Explanation
(Nothing)	All files in "root" directory
/	All files in "root" directory
/saved	All files in "saved" directory
*.*	All files in all directories
/del	Deletes all files in the root director
/saved/del	Deletes all files in the saved directory
del*.*	Deletes files in all directories

### ***Autodiscrimination***

You can enable most or specific symbol types by the following operational commands.

**Default:**       **Code 39 (only)**

**<P>** Enables most symbol types.

**Options:**       **<Q>** Enable Code 39 only

**<R>** Enable Codabar only

**<S>** Enable I 2/5 only



# **13 Unique Item Identifiers**

## **Contents**

Ull Overview .....	13-2
Non-Ull Characters in a Ull Message Stream .....	13-3
Ull Mode Features.....	13-4
Error Messaging .....	13-6
Valid Formats .....	13-8

This section explains the structure and purpose of Unique Item Identifiers (Ulls), and how to configure the Quadrus EZ to read them.

# Overview of IUID and UII

The Department of Defense (DoD) now requires “Item Unique Identification” (IUID) for all products sold to the DoD by private vendors. A Unique Item Identifier (UII) is like a Social Security number for each part. The UII must be encoded in a Data Matrix ECC 200 symbol that conforms to the data structure defined in the DoD’s “Guide for Uniquely Identifying Items”.

## UII Elements

UIIs come in two forms, called **Construct 1** and **Construct 2**. The following is an example of Construct 2. Construct 1 is identical, except that it doesn’t include a part number. Construct 2 is composed of three basic elements:

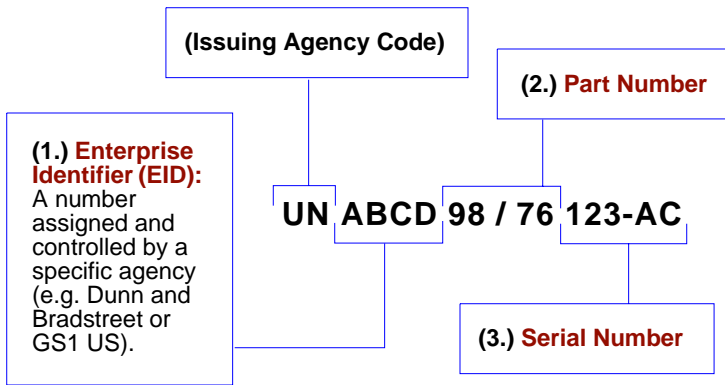

## Encoding a UII

The information in a Data Matrix UII also includes a compliance indicator, data qualifiers, and data element separators. None of these elements are part of the final UII. When **UII-Only** is enabled in the Quadrus EZ, the characters that are not part of the UII are removed from the decoded symbol data. Only characters that make up the UII are passed on to the host computer. Otherwise, the symbol is rejected.

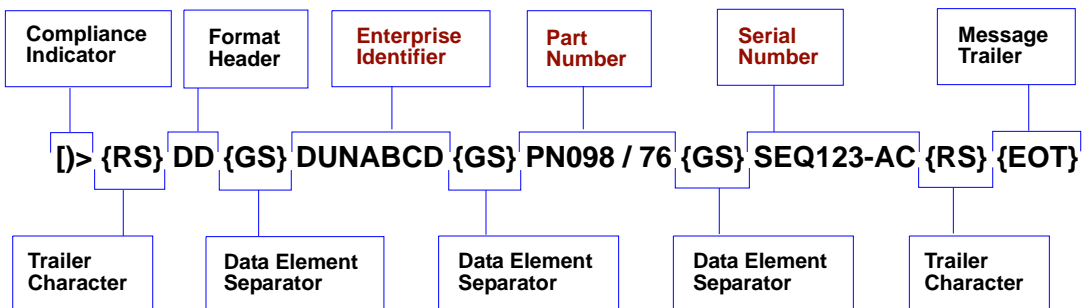

## Non-UII Characters in a UII Message Stream

The table below identifies and describes all characters in a UII message stream that are not part of the final UII sent to the host.

### *Non-UII Characters in a UII Message Stream*

<i>Compliance Indicator</i>	Identifies to the Quadrus EZ that the symbol contains a UII.
<i>Format Header</i>	Describes the type of data qualifier used. These qualifiers include AI (format 05), DI (format 06), and TEI (format DD).
<i>Trailer Character</i>	An ASCII character that separates the compliance indicator from the format header information, and also appears at the end of the message stream.
<i>Data Element Separator</i>	An ASCII character used to separate data fields.
<i>Message Trailer</i>	Identifies the end of the message within the data stream.
<i>Data Qualifier</i>	Defines each data element placed in the UII message stream.

When a message stream in any of the three available formats is read by the Quadrus EZ, non-UII characters are omitted and the UII is sent to the host.

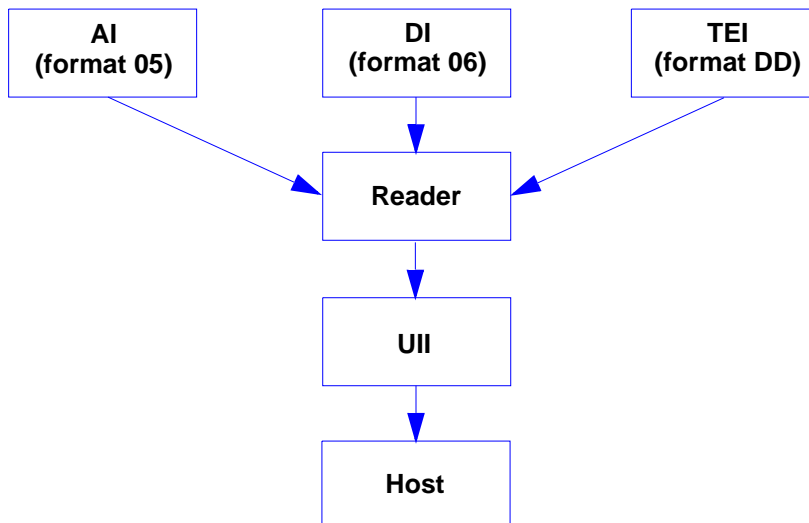

# UII Mode Features

<i>UII-Only Enabled</i>	Allows the Quadrus EZ to read <i>only</i> UII message streams encoded in ECC 200 Data Matrix symbols and to send the UII output to the host computer. The Quadrus EZ will not read any other symbol data when UII-Only is enabled.
<i>UII-Only Enabled with Error Messaging</i>	Allows the Quadrus EZ to read <i>only</i> UII message streams encoded in ECC 200 Data Matrix symbols and to send the UII output to the host computer. In addition, the Quadrus EZ will send an error message to the host if the UII message stream is invalid.
<i>UII Enabled with Pass Through</i>	Allows both UII-encoded symbols and non-UII symbols to be decoded and sent to the host.
<i>UII Enabled with Error Messaging and Pass Through</i>	Allows the Quadrus EZ to decode UII symbols and non-UII symbols, and to provide error messages if the UII message stream is invalid.

## UII Mode by ESP

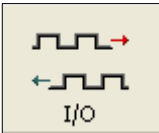

Click this button to bring up the **I/O Parameters** menu.

To change settings, **double-click** the setting and use your cursor to scroll through the options.

**Open** the nested **Unique Item Identifier** option in the **I/O Parameters** tree control.

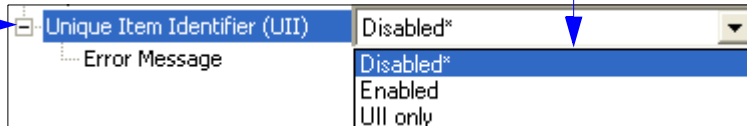

**Note:** The setting **Enabled** in ESP's UII tree controls is functionally identical to **UII Enabled with Pass Through** in the table at the top of this page. Therefore, the combination of **UII Enabled** and **Error Message Enabled** is functionally identical to the **UII Enabled with Error Messaging and Pass Through** condition in the table at the top of the page.

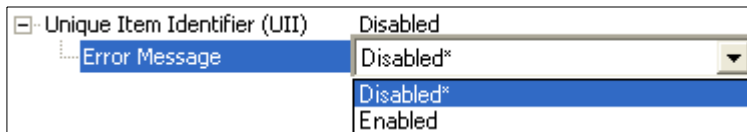

## UII Mode by Serial Command

*Serial Cmd:* <**K455**,*status*,*errstatus*>  
*Default:* **Disabled**  
*Options:* **0 = Disabled**  
1 = UII Enabled with Pass Through  
2 = UII-Only Enabled

### UII Disabled

No UII is constructed when symbol data is read.

### UII Enabled with Pass Through

*Usage:* Use when symbols may contain either non-UII data or UII data.  
*Definition:* Message streams with valid UII compliance indicators will be evaluated as UIIs. All other data will be processed in the normal manner.

### UII-Only Enabled

*Usage:* Use when symbols will contain only UII data, or when symbols with non-UII data are to be rejected.  
*Definition:* All data will be treated as potential UII data and symbols that do not comply with DoD UII guidelines will be rejected.

### UII Mode Error Messaging







*Serial Cmd:* <**K455**,*status*,*errstatus*>  
*Default:* **Disabled**  
*Options:* **0 = Disabled**  
1 = Enabled  
*Usage:* Identifies problems with data in UII format.  
*Definition:* Evaluates the UII elements and returns an error message if invalid UII elements are found.

**Important:** When **Error Messaging** is disabled, any symbol with data that does not conform to UII format will be treated as a NOREAD.







# Error Messaging

This feature is used to determine if UII message streams are in the correct format. When **Error Messaging** is enabled, the Quadrus EZ sends a message to the host indicating an error every time a bad symbol is read. The table below shows examples of error messages.

## Examples of Error Messages

<p><i>Invalid Format Header</i></p>	<p>[]&gt;{RS}<b>15</b>{GS}800406141411A0B9C3D6{RS}{EOT}  <b>Error message:</b> "Invalid UII Format Header"</p>	
<p><i>Invalid AI</i></p>	<p>(01 + 21)  &gt;[]&gt;{RS}05{GS}0100061414199999{GS}<b>31</b>1A0B9C3D6{RS}{EOT}  <b>Error message:</b> "Invalid AI"</p>	
<p><i>Invalid DI</i></p>	<p>(UN + 12V + 1P + S)  &gt;[]&gt;{RS}06{GS}<b>12X</b>077991289{GS}1P4202435{GS}S10936{RS}{EOT}  <b>Error message:</b> "Invalid DI"</p>	
<p><i>Invalid TEI</i></p>	<p>(D + CAG + SER)  &gt;[]&gt;{RS}DD{GS}<b>CAX</b>987654{GS}SERMKLJHUIYD{RS}{EOT}  <b>Error message:</b> "Invalid TEI"</p>	
<p><i>Space in Data Qualifier</i></p>	<p>[]&gt;{RS}05{GS}8 0040614 1411 A0 B9 C3D6{RS}{EOT}  <b>Error message:</b> "Invalid AI (or DI or TEI depending on format in use)"</p>	
<p><i>Lower Case Characters</i></p>	<p>[]&gt;{RS}05{GS}800406141411<b>a</b>0B9C3<b>d</b>6{RS}{EOT}  <b>Error message:</b> "Invalid Characters in Data"</p>	

Examples of Error Messages (cont.)

<p><i>Invalid Characters</i></p>	<p>()&gt;{RS}05{GS}800406141411#0B9C3D6{RS}{EOT}  <b>Error message:</b> "Invalid Characters in Data"</p>	
<p><i>UII Too Long</i></p>	<p>(Character limit: 78)          ()&gt;{RS}05{GS}80021234567891123456789212345678931234567894123456789512345678961234567897123456789{RS}{EOT}  <b>Error message:</b> "UII Too Long"</p>	
<p><i>Part Number Too Long</i></p>	<p>(Character limit: 32)          ()&gt;{RS}DD{GS}DUNABCD{GS}PNO1234567891123456789212345678931234{GS}SEQ123-AC{RS}{EOT}  <b>Error message:</b> "UII Part Number Too Long"</p>	
<p><i>Serial Number Too Long</i></p>	<p>(Character limit: 30)          ()&gt;{RS}DD{GS}DUN-ABCD{GS}PNO09876{GS}SEQ1234567891123456789212345678931{RS}{EOT}  <b>Error message:</b> "UII Serial Number Too Long"</p>	
<p><i>EID Too Long</i></p>	<p>(Character limit: 13)          ()&gt;{RS}DD{GS}DUN12345678911234211{GS}PNO98/76{GS}SEQ123-AC{RS}{EOT}  <b>Error message:</b> "UII EID Too Long"</p>	
<p><i>Invalid Compliance Indicator</i></p>	<p><b>D)</b>&gt;{RS}05{GS}800406141411A0B9C3D6{RS}{EOT}  <b>Error message:</b> "Invalid UII Compliance Indicator"          The following symbol <i>will read</i> in <b>UII with Pass Through</b> mode, because the invalid compliance indicator suggests that the encoded characters form a non-UII message stream.</p>	

# Valid Formats

The table below shows examples of correctly encoded UII message streams and the decoded UII output.

## Examples of Valid UII Message Streams and UII Output

<i>AI (Format 05)</i>	<b>Encoded message stream:</b> []>{RS}05{GS}0100061414199999{GS}211A0B9C3D6{RS}{EOT} <b>Decoded UII output:</b> 000614141999991A0B9C3D6	
<i>DI (Format 06)</i>	<b>Encoded message stream:</b> []>{RS}06{GS}18SOCVA5674A36458{RS}{EOT} <b>Decoded UII output:</b> DOCVA5674A36458	
<i>TEI (Format DD)</i>	<b>Encoded message stream:</b> []>{RS}DD{GS}CAG987654{GS}SERMKJHUIYD{RS}{EOT} <b>Decoded UII output:</b> D987654MKLJHUIYD	



# **14** *Output Format*

## **Contents**

Output Format Serial Commands.....	14-2
Output Format Status .....	14-3
Format Assign .....	14-4
Format Extract.....	14-5
Format Insert.....	14-7
Output Filter Configuration .....	14-9
Ordered Output Filter .....	14-13

This section explains how to control the formatting and filtering of decoded symbol data for output.

## Output Format Serial Commands

Format Extract	< <b>K740</b> , <i>output index,start location,length</i> >
Format Insert	< <b>K741</b> , <i>output index,length,hex string</i> >
Format Assign	< <b>K742</b> , <i>symbol number,status</i> >
Format Status	< <b>K743</b> , <i>output format status</i> >
Output Filter Configuration	< <b>K744</b> , <i>filter number,symbology type,length,wildcard,placeholder,data,unused,database index</i> >
Ordered Output Filter	< <b>K745</b> , <i>number of filters</i> >

# Output Format Status

**Definition:** This is a global enable/disable parameter. In order to use formatting you must set up the format using the insert and extract commands, and you must also assign a symbol to format using the **Format Assign** command.

**Serial Cmd:** <**K743,output format status**>

**Default:** **Disabled**

**Options:** **0 = Disabled**      1 = Enabled

## Output Format Status Disabled

When **Format Status** is set to **Disabled**, output formatting is globally disabled.

## Output Format Status Enabled

When **Format Status** is set to **Enabled**, output formatting is enabled. However, **Format Assign**, **Format Insert**, and **Format Extract** must be properly set up as well.

### By ESP

On the **Output Format** tab, check the **Enable Output Format** box.

The screenshot shows the 'Output Format' configuration window. The 'Output Format' tab is active. The 'Enable Output Format' checkbox is checked and highlighted with a blue arrow. The 'Auto Sync with Reader' checkbox is also checked. The 'Set Number of Symbols' is set to 1. The 'Output Phrase' section contains three input fields: 'Preamble' with 'CR', 'Symbol #1' with a QR code, and 'Postamble' with 'CR LF'. Below these fields are three checkboxes: 'Enable' (checked), 'Parse' (checked), and 'Enable' (checked). At the bottom, there are three buttons: 'Parse Symbols', 'Send and Save', and 'Receive'. A 'Show Parse Table' button is also visible at the bottom left.

# Format Assign

## Symbol Number

**Definition:** **Symbol Number** refers to the number of the symbol to which output formatting will apply. For example, if you wish to enable user-defined formatting to symbol # 2 in a multisymbol read cycle, you would send the command **<K742,2,1>**. Note that the number of symbols may exceed the format capabilities.

**Serial Cmd:** **<K742, symbol number, status>**

**Options:** 1 to 10  
1 = Formatted output status for symbol # 1.  
2 = Formatted output status for symbol # 2.  
...  
10 = Formatted output status for symbol # 10.

## Status

**Definition:** **Status** refers to the user-defined formatting of a selected symbol position in the read cycle result. Note that there is also a global formatting “enable” command that must be set for the formatting to be applied.

**Serial Cmd:** **<K742, symbol number, status>**

**Default:** **Disabled**

**Options:** **0 = Disabled**     1 = Enabled (Assign parameters to specified symbol.)

## By ESP

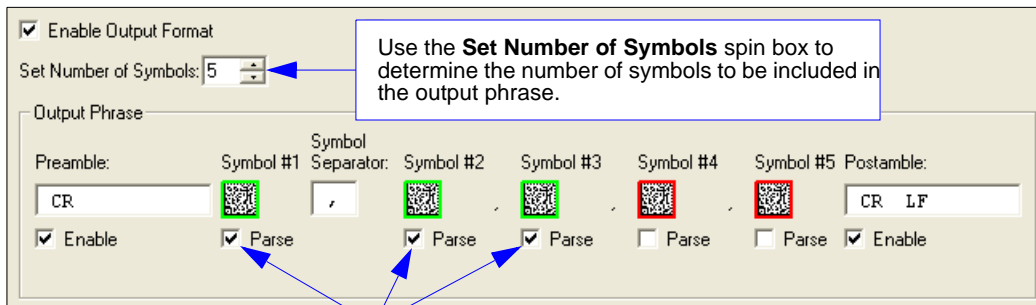

Then check the **Parse** boxes beneath the symbols that you wish to format for user-defined output.

---

# Format Extract

## Output Index

**Definition:** **Output Index** refers to the database entry you wish to modify with this command. A formatted output is built by *extracting data from a symbol's original data output* and/or inserting user-defined characters.

It may be helpful to think of individual indexes as positions in the final formatted output you wish to build. Starting with index # 1, enter either an extract or insert command to begin building your desired output string. Then, with the next index number, enter either an extract or insert command to continue building the output string. Continue this process until you are finished building the string.

**Serial Cmd:** <**K740,output index,start location,length**>

**Options:** 1 to 100

## Start Location

**Definition:** Defines the location within the symbol data where the character extraction will begin. The first character extracted will also be the first character in the sequence displayed in user-defined output.

**Serial Cmd:** <**K740,output index,start location,length**>

**Default:** **0**

**Options:** 1 to *n* (maximum number of characters in the symbol data).

## Length

**Definition:** Defines the length (in consecutive characters) that will be extracted and placed in user-defined output.

**Serial Cmd:** <**K740,output index,start location,length**>

**Default:** **0** (disabled; end of format cell array)

**Options:** 1 to *n* (maximum number of characters in the symbol data).

## Format Extract by ESP

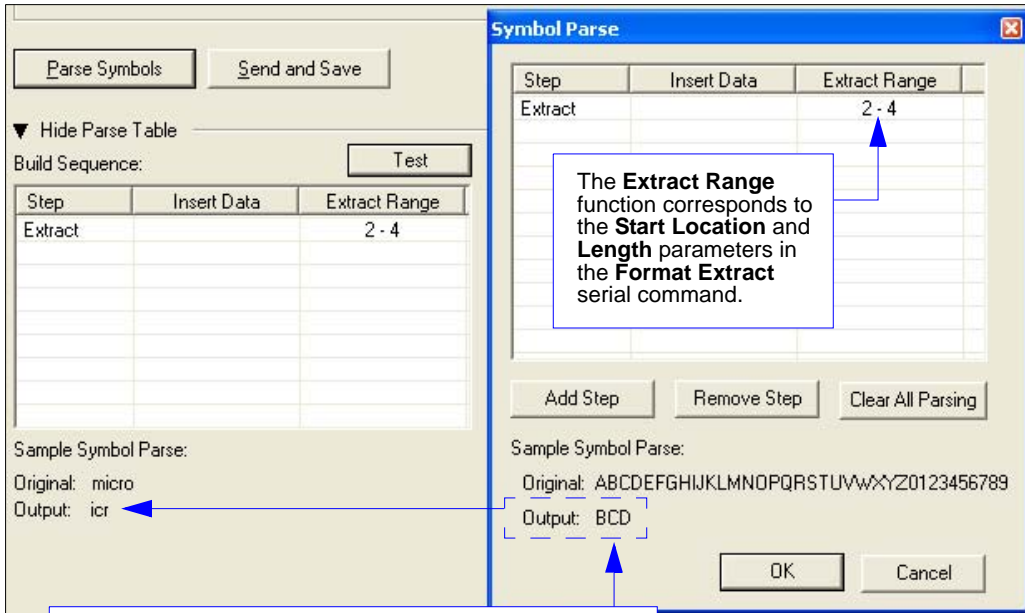

You can extract and insert several character sequences using **ESP's Symbol Parse** feature. In this example, the selected extraction range is characters 2-4. The "Sample Symbol Parse" example on the **Symbol Parse** dialog shows the selected character positions extracted and output as desired. Simultaneously, the data string from the actual selected symbol is displayed at the bottom left of the **Parse Table**, followed by the user-defined extracted output ("icr" in this example).

# Format Insert

## Output Index

**Definition:** **Output Index** refers to the database entry you wish to modify with this command. A formatted output is built by extracting data from a symbol's original data output and/or *inserting user-defined characters*.

It may be helpful to think of individual indexes as positions in the final formatted output you wish to build. Starting with index # 1, enter either an extract or insert command to begin building your desired output string. Then, with the next index number, enter either an extract or insert command to continue building the output string. Continue this process until you are finished building the string.

**Serial Cmd:** <**K741**, *output index*, *length*, *hex string*>

**Options:** 1 to 100

## Length

**Definition:** Specifies the length of the user-defined character string that will be inserted. This function is limited to 4 characters per output index, so multiple indexes must be entered in order to insert longer character sequences.

For example, if you wish to insert a 10 character sequence in user-defined output, you would need three commands with consecutive index numbers, where the first two character sequence lengths were 4 and the third was 2.

**Serial Cmd:** <**K741**, *output index*, **length**, *hex string*>

**Default:** **0** (disabled; end of format cell array)

**Options:** 1 to 4

## Hex String

**Definition:** Specifies a character string that represents ASCII characters to be inserted in the database entry. Two hex characters are required for every ASCII character to be inserted in the user-defined output string. These two characters comprise the hex (base 16) value of the ASCII character.

For example, if you wanted to enter the three-character sequence "Hi!" you would enter **3** for the length of the string, and a hex sequence of **486921** for the ASCII sequence to be inserted. (48 = H; 69 = i; 21 = !)

**Important:** Each pair of hex characters represents one ASCII character. Hex character pairs range from 00 to FF. Since you are limited to 4 ASCII characters per insertion per database entry, you are likewise limited to 8 hex characters per insertion per database entry.

**Serial Cmd:** <**K741**, *output index*, *length*, **hex string**>

**Default:** **NULL (00)**

**Options:** 00 to FF (As many as 4 bytes, or hex pairs.)

# Format Insert by ESP

**Symbol Parse**

Step	Insert Data	Extract Range
Insert		

Add Step Remove Step Clear All Parsing

Sample Symbol Parse:  
Original: ABCDEFGHIJKLMNOPQRSTUVWXYZ0123456789  
Output:

OK Cancel

**Insert**

SP SP

SOH	STX	ETX	EOT	ENQ
ACK	BEL	BS	HT	LF
VT	FF	CR	SO	SI
SL	DC1	DC2	DC3	DC4
NAK	SYN	ETB	CAN	EM
SUB	ESC	FS	GS	RS
US	SP			

Click 'Delete' to remove characters.

OK Cancel

The **Format Insert** process is very similar to the **Format Extract** process, except that **Insert** allows you to enter characters using the Insertion Calculator (shown above).

Parse Symbols Send and Save

Hide Parse Table

Build Sequence: Test

Step	Insert Data	Extract Range
Insert	SP SP	
Extract		3 - 5

Add Step Remove Step Clear All Parsing

Sample Symbol Parse:  
Original: micro  
Output: cro

**Symbol Parse**

Step	Insert Data	Extract Range
Insert	SP SP	
Extract		3 - 5

Add Step Remove Step Clear All Parsing

Sample Symbol Parse:  
Original: ABCDEFGHIJKLMNOPQRSTUVWXYZ0123456789  
Output: CDE

OK Cancel

Notice that **Extract** and **Insert** share the same **Parse Table**.



---

# Output Filter Configuration

*Definition:* Output filtering is a method of providing a set of good read qualifiers and also providing ordered output. There is a filter for up to the first 10 positions in a multisymbol output. The first filter corresponds to the first symbol output at the end of the read cycle. Each filter has settings for the following four parameters: **Symbology Type**, **Symbol Length**, **Data**, and **Configuration Database Number**.

*Serial Cmd:* <**K744**, *filter number,symbology type,length,wildcard,placeholder,data,unused,database index*>

## Rules for Output Filter Configuration

### **Rule # 1**

Each symbol that is decoded must match one of the filters before it can be saved to a read cycle record. There is an exception to this rule, however, when the number of symbols required for a read cycle exceeds the number of active filters. In such a case, unfiltered symbols can be placed into unfiltered output positions.

For example, if the number of symbols required is 6 but there are only 4 active filters, the last 2 positions can be filled by any (unfiltered) qualified symbol.

### **Rule # 2**

The same filter setup can be used multiple times.

For example, filters 1, 2, and 3 can be set up to filter Data Matrix symbols, and the output will occur in the order the symbols are decoded.

### **Rule # 3**

All qualified symbols will be sorted and output in the matching filter position. If a symbol matches filter 3, it will be output as the third symbol. If a filter does not have a matching qualified symbol, a NOREAD message will be output in place of the symbol (assuming the NOREAD message is enabled).

For example, if there is not a symbol that meets filter 3's requirements, then a NOREAD message will be output in the third output position.

## Filter Number

**Definition:** This is the filter index number that represents the position of the symbol in the data output at the end of the read cycle. This index number should be entered along with the following filter settings for the predetermined symbol position.

**Serial Cmd:** <**K744**, **filter number**, *symbology type*, *length*, *wildcard*, *placeholder*, *data*, *unused*, *database index*>

**Options:** 1 to 10

## Symbology Type

**Definition:** Specifies the symbology type allowed to occupy this location in multi-symbol output.

**Note:** To filter or order a symbol, the symbol must meet all the requirements of the selected filter index.

**Serial Cmd:** <**K744**, *filter number*, **symbology type**, *length*, *wildcard*, *placeholder*, *data*, *unused*, *database index*>

**Default:** **0** (any symbology type)

**Options:**

- 0 = Any type
- 1 = Interleaved 2 of 5
- 2 = Code 39
- 3 = Code 128
- 4 = Codabar
- 5 = UPC
- 6 = PDF417
- 7 = EAN 128
- 8 = Code 93
- 9 = PharmaCode
- 10 = RSS
- 11 = MicroPDF417
- 12 = Composite
- 13 = BC412
- 14 = Data Matrix
- 15 = QR Code

## Length

**Definition:** Specifies the length of the decoded symbol allowed to occupy this location in multi-symbol output.

**Note:** To filter or order a symbol, the symbol must meet all requirements of the selected filter index.

**Serial Cmd:** <**K744**, filter number, symbology type, **length**, wildcard, placeholder, data, unused, database index>

**Default:** **0**

**Options:** 0 to 64

## Wildcard

**Definition:** This is the character to be used in the data output field when performing a data filter comparison. The wildcard character represents the end of matching, and allows for variable lengths of symbol output.

**Serial Cmd:** <**K744**, filter number, symbology type, length, **wildcard**, placeholder, data, unused, database index>

**Default:** “ \* ” = **2A** (hex)

**Options:** Any ASCII input in the form of a pair of hex characters.

**Example:**

2A = \*

00 = disabled

## Placeholder

**Definition:** The placeholder character requires a character to be present, but does not compare the data value.

**Serial Cmd:** <**K744**, filter number, symbology type, length, wildcard, **placeholder**, data, unused, database index>

**Default:** “ ? ” = **3F** (hex)

**Options:** Any ASCII input in the form of a pair of hex characters.

**Example:**

3F = ?

00 = disabled

## Data

**Definition:** This is the data string to be used when comparing symbol data for output filtering and ordering. This data string may also contain wildcard and placeholder characters to facilitate matching. Remember that in order to filter or order symbol data, it must meet all the requirements of the selected filter index.

**Examples:**

- Filter data = "123\*". This will match data strings of "123", "123456", and "123ABC", but not "12".
- Filter data = "123\*AB?C". This will be interpreted as "123\*".
- Filter data = "123?". This will match "1234" and "123A", but not "123", "12345", or "1234C".
- Filter data = "123?A". This will match "1234A" and "123BA", but not "123", "1234C", or "1234ABCD".
- Filter data = "123?A?". This will match "1234AB" and "123BAT", but not "1234A" or "123BATS".
- Filter data = "12??\*". This will match "1234", "123456", and "123ABC", but not "12" or "123".
- Filter data = "123?A\*". This will match "1234A", "123BA", and "123BATS", but not "1234" or "1234C".

**Serial Cmd:** <K744, filter number, symbology type, length, wildcard, placeholder, data, unused, database index>

**Default:** 00

**Options:** Any ASCII input in the form of a pair of hex characters.

**Examples:**

41422A = AB\*

Data [0] = null represents string matching disabled.

## Database Index

**Definition:** The index of the database entry that decodes a given symbol must equal this setting for filtering to occur. A setting of 0 allows any database index for this filter entry.

**Serial Cmd:** <K744, filter number, symbology type, length, wildcard, placeholder, data, unused, database index>

**Default:** 0 (any index)

**Options:** 0 to 10

## Ordered Output Filter

*Definition:* **Number of Filters** refers to the number of active output filters. **0** disables all output filters. Any non-zero numeral will enable filtering to be performed using the filter indexes covered by this value.

For example, if the number of filters is **1**, then only filter index # 1 will be applied. If the number of filters is **2**, then only filter index # 1 and filter index # 2 will be applied, etc.

*Serial Cmd:* **<K745,number of filters>**

*Default:* **0**

*Options:* 0 to 10



# 15 Ethernet

## Contents

Step 1 Setup.....	15-2
Step 2 Preliminary Steps .....	15-3
Step 3 Communicating in Ethernet.....	15-7
Step 4 Ethernet Application .....	15-8

This section only applies to Quadrus EZ readers that are designed for Ethernet connectivity.

While it is possible to connect the Quadrus EZ directly to your host computer by Ethernet TCP/IP, typical usage is in a networked environment with either a switch or router.

**Note:** The characters **NULL** <> and , can only be entered through embedded menus, not through **ESP** or serial commands.

---

## *Step 1 —Setup*

*For Ethernet setup, you will need:*

- A Quadrus EZ Ethernet-ready reader with application code **-14** or newer and **ESP** version **1.2** or newer.
- An IB-151 Ethernet/USB interface.
- An IB-150 kit (interface and cable).
- An Ethernet switch or router. RJ45 Ethernet cables (use a crossover cable if connecting directly to the host computer).
- A Laptop or Desktop host computer with Ethernet connectivity to a network and Windows 98 or 2000.



## Step 2 —Preliminary Steps

1. Plug the IB-151 interface into the Quadrus EZ.
2. Plug the IB-150 kit cable into the IB-151 and make the connection to the host computer and power supply.
3. Connect the Ethernet cables from the IB-151 interface to the switch or router and from the switch or router to the host computer.  
The “NETWORK STATUS” LED on the side of the Quadrus EZ should light green when the Ethernet cable is connected.
4. Start **ESP** and establish communication with the host computer through the RS-232 host port.

There are three ways the Quadrus EZ can connect to a host by Ethernet:

- Assigning a network address.
- Using the reader’s default IP address.
- Using DHCP (Dynamic Host Configuration Protocol) assignment.

## Assigning a Network Address

This procedure will configure the reader to work with the TCP/IP configuration of the host computer.

**Note:** This is only a temporary solution since the preferred method is to receive IP, subnet, and gateway (if necessary) from your IS department.

If an IP address has been assigned to the reader by the IS department (the most appropriate method), skip steps 1-3 below.

1. Determine the host computer's IP address on the host's network:

Go to the Windows Start menu, select **Run**, type **command** and press **Enter**.

a) On Win2K computers, at the command prompt, type **ipconfig**.

b) On Win98 computers type **winiptcfg** and select the **Ethernet Interface** in the drop-down box.

2. To the IP Address of the host computer add '1' to the last decimal value. This will be the IP address that you will assign to the reader.

For example, if the host computer's IP is 123.234.1.25, the reader's IP will be 123.234.1.26.

3. To verify that the new IP address is available, go back to the command prompt and type in the command: **ping [reader IP address]**. For example: ping 123.234.1.26.

If the ping program responds with "Request timed out" message, then the IP address can probably be used temporarily. If you get a "Reply" message, then that address has already been assigned to another device and you need to contact your IS department for an available IP address.

4. Do **Receive Reader Settings**.

5. From the **ESP Communications** menu, enter your reader's new IP address, for example, 123.234.1.26, and save this to the reader.

The reader is now configured with an IP address that will allow communication with the host computer. In the **ESP Communications** menu, you should see the following:

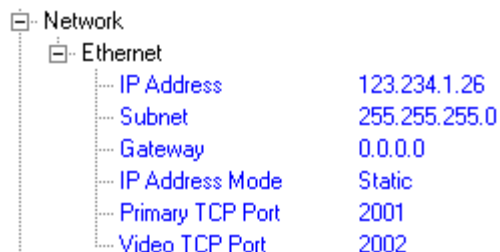
A screenshot of a configuration menu. At the top is 'Network' with a small icon. Below it is 'Ethernet' with a small icon. Under 'Ethernet', there are several settings listed in a list format:

- IP Address: 123.234.1.26
- Subnet: 255.255.255.0
- Gateway: 0.0.0.0
- IP Address Mode: Static
- Primary TCP Port: 2001
- Video TCP Port: 2002

6. Go to Step 3, **Communicating in Ethernet**.

## Using the Reader's Default IP Address

**Note:** This procedure is only used when the reader is directly connected to the computer. Also, this is only a temporary solution since the preferred method is to receive IP, subnet, and gateway (if necessary) from your IS department.

1. Determine the host computer's IP address on the host's network:  
Go to the start menu, select **Run**, type **command** and press **Enter**.
  - a) On Win2K computers, at the command prompt, type **ipconfig**.
  - b) On Win98 computers type **winiipcfg** and select the **Ethernet Interface** in the drop-down box.
2. Note the **IP Address** of the host computer.
3. At the Windows command prompt, type **route add 192.168.0.100 [host computer IP]** and press **Enter**. This adds the reader's IP to the computers routing table.
4. At the Windows command prompt, type **route print** and press **Enter**.

The command prompt should display something similar to the following:

```
C:\WINNT\System32\CMD.exe
Active Routes:
Network Destination        Netmask          Gateway
          0.0.0.0             0.0.0.0          162.148.26.1
          127.0.0.0         255.0.0.0         127.0.0.1
          162.148.0.0       255.255.0.0       162.148.37.65
          162.148.37.65     255.255.255.255   127.0.0.1
          162.148.255.255   255.255.255.255   162.148.37.65
          192.168.0.100     255.255.255.255   162.148.37.65
          224.0.0.0          224.0.0.0         162.148.37.65
          255.255.255.255   255.255.255.255   162.148.37.65
Default Gateway:          162.148.26.1
```

5. Look for the "192.168.0.100" in the **Network Destination** column. If it does not appear here, contact your IS department.
6. Go to Step 3, **Communicating in Ethernet**.

---

## Using DHCP to Configure the Reader

This assumes that the Quadrus EZ is connected to a network on which resides a DHCP server. RS-232 configuration is required to enable the reader's DHCP client (default "IP address mode" setting is "static", which disables DHCP).

1. Do **Receive Reader Settings**.
2. Under **Network** in the **ESP Communications** menu, double click on **IP Address Mode** and change **Static** to **DHCP**.
3. Right click on the **Communications** menu and do **Save to Reader/Send no Save**.
4. Do **Receive Reader Settings**.
5. Notice that the network will have assigned new numbers to the **IP Address**, **Subnet**, and **Gateway**, as shown here:  
(If the numbers have not changed, contact your IS department.)
6. Go to Step 3, **Communicating in Ethernet**.

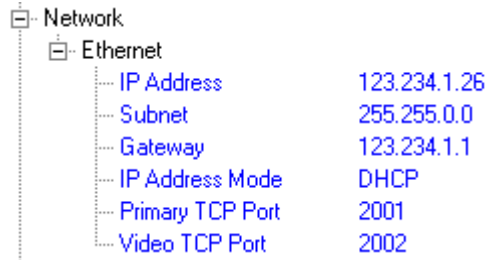

The image shows a screenshot of a network configuration window. It has a tree view on the left with 'Network' expanded to show 'Ethernet'. To the right, a list of settings is displayed with their current values. The values for IP Address, Subnet, and Gateway are highlighted in blue, indicating they have been updated.

Network	
Ethernet	
IP Address	123.234.1.26
Subnet	255.255.0.0
Gateway	123.234.1.1
IP Address Mode	DHCP
Primary TCP Port	2001
Video TCP Port	2002

## Step 3 —Communicating in Ethernet

By now either the reader should be configured with an IP address or the host computer is configured to use the reader's default IP address. Now **ESP** needs configuration:

1. In **ESP** under the **Connect** pull down menu, select **Settings...**
2. Click the **TCP/IP** tab.
3. Type in the reader's IP address (as shown on the **ESP Communications** menu).
4. Click **Connect**.
5. After a few seconds, **ESP** should display "**CONNECTED**" at the bottom of the window.

---

## Step 4 —Ethernet Application

The Quadrus EZ supports the Microscan communication protocol for readers over two TCP/IP ports. This is the same “protocol” that is supported through the reader's RS-232 Host serial port. Note that on Ethernet, the Quadrus EZ is a server device, which requires the Host to establish the connection. Once the connection is established, however, the reader will send bar code and diagnostic message data whenever it is generated.

### **Network Protocols Supported**

The Quadrus EZ supports the following RFC-compliant protocols:

IP	RFC0791, RFC950
ICMP, PING	RFC0792
TCP	RFC0793
Sockets	BSD v4.3
ARP	RFC0826
DHCP client	RFC0951, RFC1541, RFC2131, RFC2563 partial support
TFTP server	Revision 2, RFC1350

Communication with the Quadrus EZ can be established via a Telnet client (raw data only, no IAC command processing), or through a custom “sockets” application. The Quadrus EZ becomes a “server” device. It listens for connect requests from the Host before communication can begin. All Quadrus EZ readers have a unique 48-bit hardware (MACID) address. This address is printed on the reader's product label.

### **Microscan Protocol/Host RS-232 Supported**

- Configuration Commands (“**K** Commands”)
- **ESP** interface commands (“**<op>**” commands)
- Utility commands **<A>** - **<Z>**
- Host preamble **<K141>** and postamble **<K142>** strings are added to command responses and bar code data.
- All bar code data formatting is supported (**<K740>**, **<K741>**).

### **Differences from Other Protocols**

- Y Modem is not supported. This includes Firmware Download command **<dy>** and **Image Send** command **<uy>**.
- Reader does not send an immediate response to the reader's **Status** command **<?>**. The response is queued for output between read cycles. Also, the response is formatted with host-port preamble and postamble characters.
- Aux port (RS-232) interaction is not supported for transferring data between Ethernet and the aux port (**Transparent, Half-, Full- Duplex**). These modes only function with the Host RS-232 port, and are not affected by Ethernet.
- Reader sends responses to “binary frame” commands out the Video TCP port when connected. If not connected, the response will be sent to the Primary TCP port.

## **Primary (Command) TCP Port**

This port is used for all command processing and data outputs (except “binary frame” command responses). The application protocol used is the same as the Host RS-232 port.

## **Video TCP Port**

The Video TCP port is transmit-only (output from the reader, read-only by the Host), and is used for “binary frame” data outputs as follows:

1. Response to **Image Send** command **<op,4>**
2. Response to **Capture and Decode** and **Save** command **<op,5>**
3. Response to **Symbol Information** command **<op,8>**
4. **Response to Histogram** command **<op,14>**

The primary purpose of this port is for access to a dedicated video stream for **Easy Setup Mode** functions in Windows-based **ESP** configuration and evaluation program, in particular. Because the format of the “binary frame” data is quite different from the reader's other command responses and outputs, sending this data on a dedicated, independent TCP port facilitates easier **ESP** implementation. Also, end users who wish to implement their own applications may find this useful since it has a consistent data type and provides access to a port whose only traffic is that which the host application has initiated.

The Video TCP port is read-only from the host's perspective. The reader does not receive any data or commands on this port. The reader only processes commands from the primary (Command) TCP port. Also, the reader only responds to the video port if the video port has a connection to the host and a command is received that requires a “binary frame” response. If the video port is unconnected, the reader will respond to the primary port. This allows hosts the option to operate over a single port.

---

## ***Image File Transfers***

The reader's image files can be accessed with either "binary frame" commands **<op,4>** and **<op,5>**, or TFTP.

### **Binary Frames**

These are primarily intended for ESP's "near-real-time video" purposes. Although it is possible to get a full-size image from the reader using an **<op,4>** or **<op,5>** command, for quicker response, it is recommended that TFTP be used.

### **TFTP Server**

A TFTP (Trivial File Transfer Protocol) client can access the reader's image files (the reader is a TFTP server). Since TFTP does not support any sort of directory structure, the host application must know the reader's file naming convention, or request an image list from the reader through the primary TCPIP port (or RS-232 port) with the **<op,9>** command.

### **Limitations**

The largest data size per packet (TCP MSS/MTU) the reader can receive and transmit is approximately 550 bytes. Since TCP/IP is used, this will not prevent larger data transmissions, but it will limit throughput.

Some host network systems may find an MTU of 550 somewhat limiting, but this should not prevent operation with any network.



# Appendices

- Appendix A General Specifications.....A-2
- Appendix B Electrical Specifications.....A-4
- Appendix C Quadrus EZ DPM .....A-8
- Appendix D Quadrus EZ FLEX.....A-9
- Appendix E Connectivity Accessories.....A-10
- Appendix F Serial Configuration Commands.....A-13
- Appendix G ASCII Table.....A-20
- Appendix H Data Matrix Symbology .....A-22
- Appendix I Determine Depth of Field.....A-23
- Appendix J Field of View and Lenses.....A-24
- Appendix K Rapid Capture Mode .....A-28
- Appendix L Object Detector.....A-30
- Appendix M Operational Tips.....A-31
- Appendix N Embedded Menus .....A-32
- Appendix O Interface Standards.....A-33
- Appendix P Multidrop Communications.....A-34
- Appendix Q Glossary of Terms.....A-37

# Appendix A — General Specifications

## Mechanical

**Height:** 2.25" (57 mm)

**Width:** 2.5" (64 mm)

**Depth:** 4.2" (107 mm)

**Weight:** 12 oz. (340g)

## Environmental

**Enclosure Rating:** IP65 (standard unit)

With video I/O option: IP54

**Operating Temperature:** 0° to 43°C (32° to 109°F)  
if mounted on a Microscan stand. If mounted on a non-metal surface, maximum operating temperature is 40°C (109°F)

**Storage Temperature:** -50 to 75°C (-58 to 167°C)

**Humidity:** up to 90% (non-condensing)

## Emissions/Immunity

**ITE Disturbances:** IEC 55022:1998 (radiated and conducted).  
Class A

**General Immunity:** IEC 55024:1998 (residential)

**Heavy Industrial Immunity:** IEC 61000-6-2:1999

## Light Source

**Type:** High output LEDs

## Light Collection

Progressive scan, square pixels. Software-adjustable shutter speed, electronic mechanism.

**CCD array:** 659 x 494 pixels

**CMOS array:** 640 by 480 pixels

## Symbology Types

**2D:** Data Matrix (ECC 0-200), QR Code

**Stacked symbologies:** PDF417, MicroPDF417, GS1 DataBar (Composite and Stacked)

**Linear:** Code 39, Code 128, I 2/5, UPC/EAN, Pharmacode, BC412

## Video Input (Option)

**Signal System:** EIA (RS-170)

**Number of Scanning Lines:** 525 lines, 30 fps, non-interlaced

**Input:** Analog 1 Vp-p

## Video Output (Option)

**Signal System:** EIA

**Number of Scanning Lines:** 525 lines, 2:1 interlaced

**Input:** Analog 1 Vp-p/75 ohm

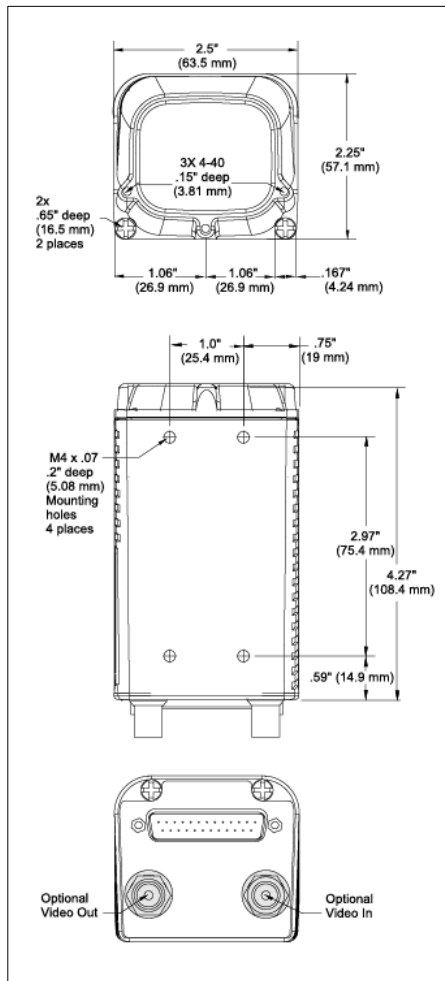

Quadrus EZ Reader Dimensions

## ***Read Parameters***

**Pitch:**  $\pm 30^\circ$  Skew:  $\pm 30^\circ$  Tilt:  $360^\circ$

**Decode Rate:** Up to 60 decodes per second

**Focal Range:** 2 to 10 inches (factory-adjustable)

## ***Indicators***

**Beeper:** Good Read, Match/Mismatch, No Read, serial command confirmation, On/Off

**LEDs:** Read performance, Power, Read Status, Network Status

## ***Communication Protocols***

**Standard Interface:** RS-232/422/485

**Optional Interface:** Ethernet

## ***Electrical***

**Power Requirements:** Input, 10 to 28VDC, 200 mV p-p max. ripple, 270 mA at 24VDC (typ. CMOS), 333mA at 24VDC (typ. CCD)

**Trigger, New Master, Input 1:** (Optoisolated) 5 to 28VDC rated (12mA at 24VDC)

**Outputs 1, 2, 3:** (Optoisolated) 1 to 28VDC rated ( $I_{CE} < 100\text{mA}$  at 24VDC, current limited by user)

## ***Safety Certifications***

FCC, CE, UL/cUL, BSMI

## ***ISO Certification***

ISO 9001:2000 Certification No. 06-1080

Issued by TÜV USA

©2008 Microscan Systems, Inc.

All rights reserved. Specifications subject to change.

Product specifications are given for typical performance at 25°C (77°F) using grade A labels. Performance characteristics may vary at high temperatures or other environmental extremes. Warranty—One year limited warranty on parts and labor. Extended warranty available.

## Appendix B — Electrical Specifications

Maximum Operating Power: CCD: 10Watts; CMOS: 8watts

Power Input: 10 to 28VDC, 200mV p-p max. ripple;

346 mA @ 24VDC (typ.) CCD; 260 mA @ 24VDC (typ.) CMOS

Trigger, New Master, Input 1: 4.5 to 28VDC (12mA @24VDC) (optoisolated)

Outputs (1,2,3): 1 to 28VDC rated

(I<sub>CE</sub> <100mA @24VDC, current limited by user) (optoisolated)

### Host 25-pin Connector

Pin	All	I/O	RS-232	AuxRS-232	RS-422/485	Ethernet
1	Chassis ground <sup>a</sup>					
2		Out	TxD			
3		In	RxD			
4		Out	RTS	Aux TxD		
5		In	CTS	Aux RxD		
6	Output 1 (+)	Out				
7	Signal ground <sup>b</sup>					
8	Output 2 (+)	Out				
9	Trigger (-)	In				
10	Trigger (+)	In				
11	Default config. <sup>c</sup>	In				
12	Input 1 (+)	In				
13					RxD (+) In	RxD (+) In
14					TxD (-) Out	RxD (-) In
15	Output 3 (+)	Out				
16					RxD (-) In	TxD (-) Out
17	Power ground <sup>d</sup>					
18	Power +10 to 28 VDC	In				
19					TxD (+) Out	TxD (+) Out
20	Output 1 (-)	Out				
21	Output 2 (-)	Out				
22	Output 3 (-)	Out				
23	Input 1 (-)	In				
24	New master (-)	In				
25	New master (+)	In				

a. Chassis ground: Used to connect chassis body to earth ground only. Not to be used as power or signal return.

b. Signal ground: Used for communication and signal line grounds only. Not to be used as power or chassis return.

c. The default is activated by connecting pin 11 to ground pin 7.

d. Power ground: Used for power return only.

**Caution:** If using your own power supply, verify correct connection of power and ground lines. Incorrect connections or use of “Chassis ground,” “Power ground,” and “Signal ground” lines could cause equipment and/or software failure.

## Optoisolator Outputs

Optoisolator circuits can transfer pulses between the reader and peripherals with no direct connection with the reader's internal circuitry. However, not every optoisolator configuration provides complete isolation. The following diagrams show both fully optoisolated and non-optoisolated circuits. They are only examples and do not represent all the possible wiring configurations.

	Iload=5mA	Iload=50mA	Iload=100mA
V <sub>Out-On</sub>	0.5V	0.5V	1.0V
t <sub>On-Typ</sub>	5mS	0.7mS	0.8mS
t <sub>Off-Typ</sub>	5μS	5μS	5μS

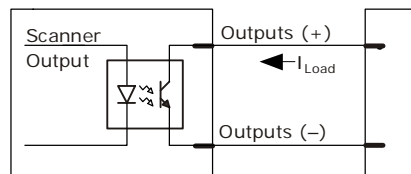

### Output Circuit Examples

#### Fully Optoisolated

This circuit is fully optoisolated and the recommended configuration. It allows the user to apply 1 to 28 VDC to the circuit.

**Caution:** The maximum current that can pass through the optoisolator is 100mA.

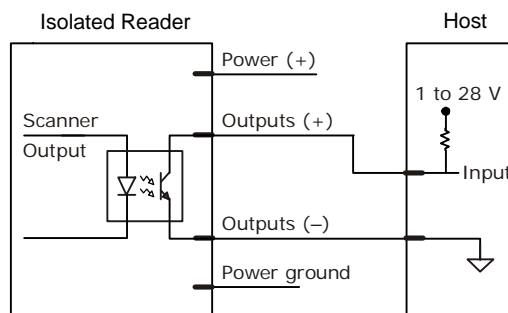

#### Not Optoisolated, Reader Grounded

In this diagram, power is applied externally, but the reader's power ground is used to complete the circuit. This setup involves some risk to the optoisolator if excessive voltages are applied.

**Caution:** The maximum current that can pass through the optoisolator is 100mA.

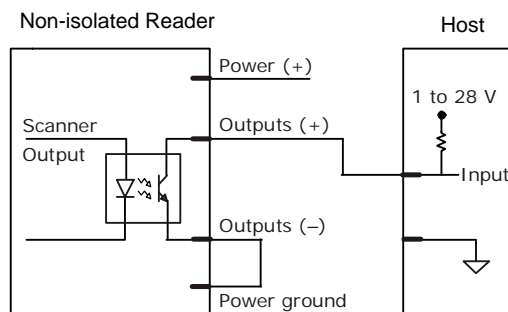

### Additional Isolated Output Circuit Examples

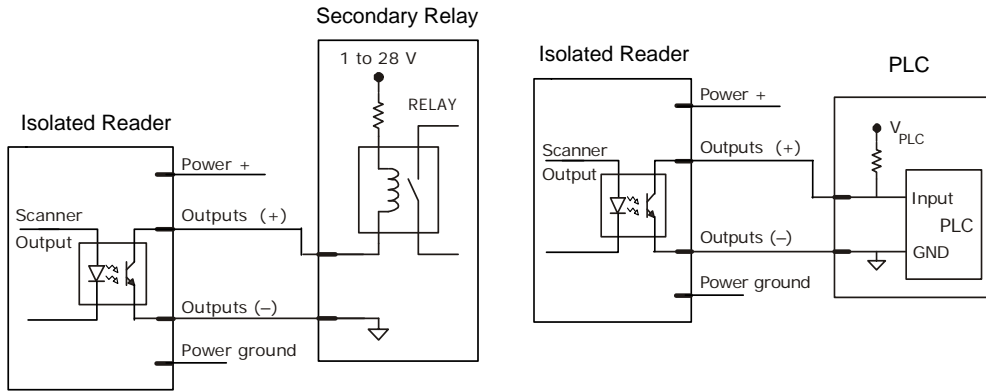

## Optoisolator Inputs

All discrete inputs can be fully isolated pulses as PNP or NPN circuits. Inputs include trigger, new master, and input 1.

Generic Waveform Characteristics

	Minimum	Maximum
VIN-HIGH/IIN-HIGH	4.5V/4mA	28V/33mA
VIN-LOW/IIN-LOW	0V/0mA	2V/2mA
Pulse Width <sub>min</sub>	48 μS	

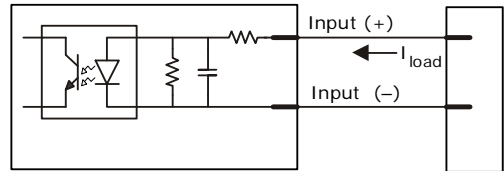

### Input Examples

#### Fully Optoisolated

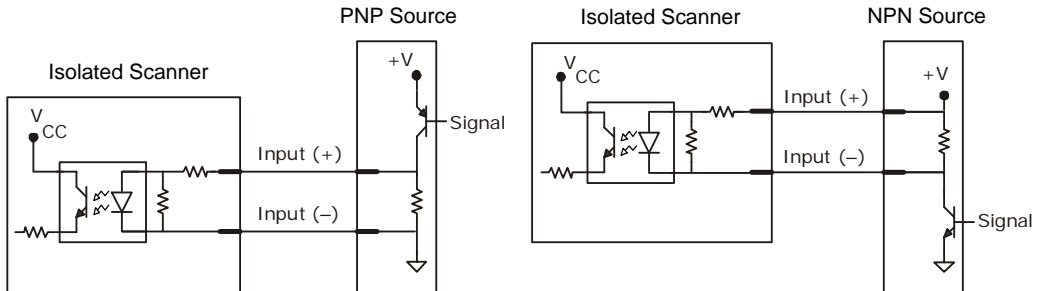

#### Not Optoisolated

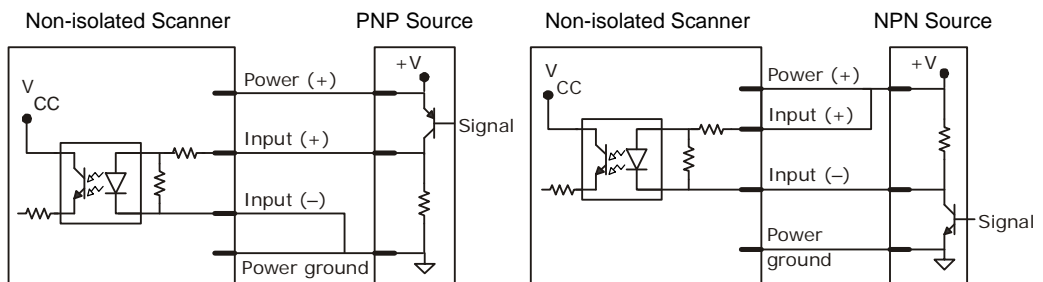

## Appendix C — Quadrus EZ DPM

The Quadrus EZ is now available in an option specifically for direct part mark applications.

The Quadrus EZ DPM Imager (FIS-6700-04XXG-XXXX) is optimized to read low-contrast direct part marks on challenging surfaces such as metal, plastic, rubber, and glass. The even illumination provided by the light diffuser and unique LED array minimizes specular reflection and improves symbol readability.

Contact your distributor or refer to Microscan's Product Pricing Catalog for detailed information about focal distance options and Quadrus EZ DPM accessories.



Standard illumination often creates specular reflection on parts with highly reflective or irregular surfaces. This can negatively impact direct part mark readability. The Quadrus EZ DPM Imager reduces specular reflection by diffusing LED illumination.

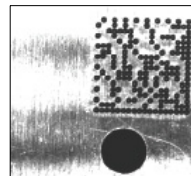

Standard

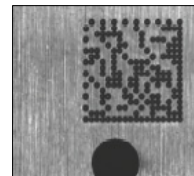

Diffused

### **Recommended Applications**

- Automotive assembly and power train
- Aerospace assembly
- Electronics manufacturing
- Medical device manufacturing

**Important:** The Quadrus EZ DPM Imager retains all other standard Quadrus EZ functionality.



## Appendix D — Quadrus EZ FLEX

The Quadrus EZ FLEX (FIS-6700-2001G) retains the firmware functionality of the standard Quadrus EZ, and adds the flexibility of a manual focus C-Mount lens and external LED illumination.

Contact your distributor or refer to Microscan's Product Pricing Catalog for detailed information about focal distance options and Quadrus EZ FLEX accessories.



### Components for a Complete Solution

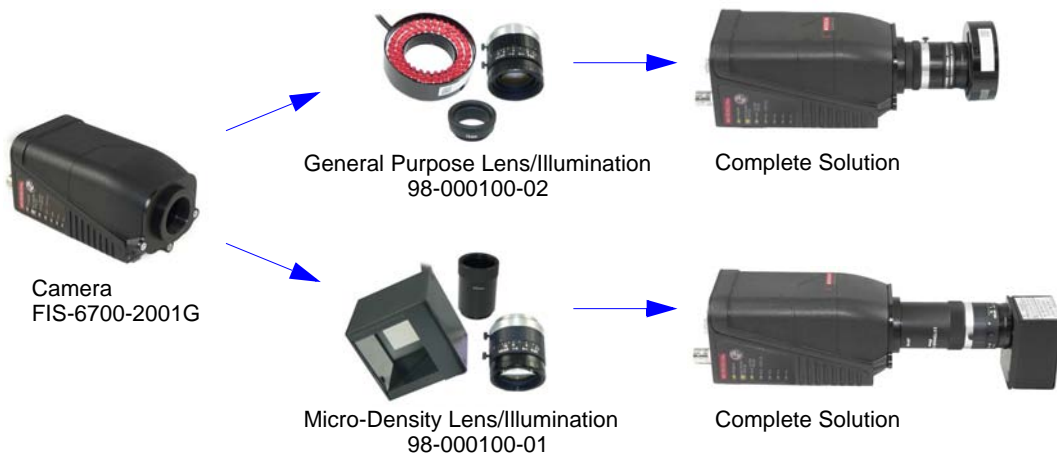

### Recommended Applications

- Factory automation
- Parts traceability
- Work-in-progress

# Appendix E — Connectivity Accessories

Three interface options are available for Quadrus EZ connectivity.

## IB-150 Kit

The IB-150 interface links the Quadrus EZ to the host, power supply, trigger, and aux port connections. In addition to multidrop and daisy chain hookups, the aux port can plug into the IB-152 interface for terminal strip wiring.

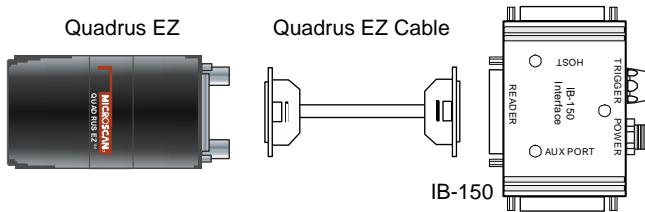

*IB-150 Port Connectors*

Pin	Reader	Host	Aux Port
1	Chassis ground	Chassis ground	Chassis ground
2	TxD	TxD	RxD
3	RxD	RxD	TxD
4	RTS/Aux TxD	RTS/Aux TxD	NC
5	CTS/Aux RxD	CTS/Aux RxD	NC
6	Output 1 (+)	Output 1 (+)	Output 1 (+)
7	Signal GND	Signal GND	Signal GND
8	Output 2 (+)	Output 2 (+)	Output 2 (+)
9	Trigger (-)	Trigger (-)	Trigger (-)
10	Trigger (+)	Trigger (+)	Trigger (+)
11	Default	Default	Default
12	Input 1 (+)	Input 1 (+)	Input 1 (+)
13	RxD (+)	RxD (+)	RxD (+)
14	TxD (-)	TxD (-)	TxD (-)
15	Output 3 (+)	Output 3 (+)	Output 3 (+)
16	RxD (-)	RxD (-)	RxD (-)
17	Power ground	NC	Power ground
18	+10 to 28 VDC	NC	+10 to 28VDC
19	TxD (+)	TxD (+)	TxD (+)
20	Output 1 (-)	Output 1 (-)	Output 1 (-)
21	Output 2 (-)	Output 2 (-)	Output 2 (-)
22	Output 3 (-)	Output 3 (-)	Output 3 (-)
23	Input 1 (-)	Input 1 (-)	Input 1 (-)
24	New master (-)	New master (-)	New master (-)
25	New master (+)	New master (+)	New master (+)

*Trigger 4-pin Connector*

Pin	Function
1	Power + 10 to 28VDC (out) <sup>a</sup>
2	Trigger (-) (in) <sup>b</sup>
3	Power Ground
4	Trigger (+) (in) <sup>a</sup>

- a. For NPN type, connect pins 1 and 4.
- b. For PNP type, connect pins 2 and 3.

*Power 3-pin Connector*

Pin	Function
1	Power Ground
2	Chassis Ground
3	Power + 10 to 28VDC (in)

**Note:** The IB-151 should be used when establishing an Ethernet connection.

## IB-151 Ethernet/USB Interface

USB (USB-B) and standard Ethernet (RJ-45) connections can be made through the IB-151 interface which plugs directly into the host port of the Quadrus EZ. The IB-151 has an second 25-pin port to pass through all but the RS-422/485 connections.

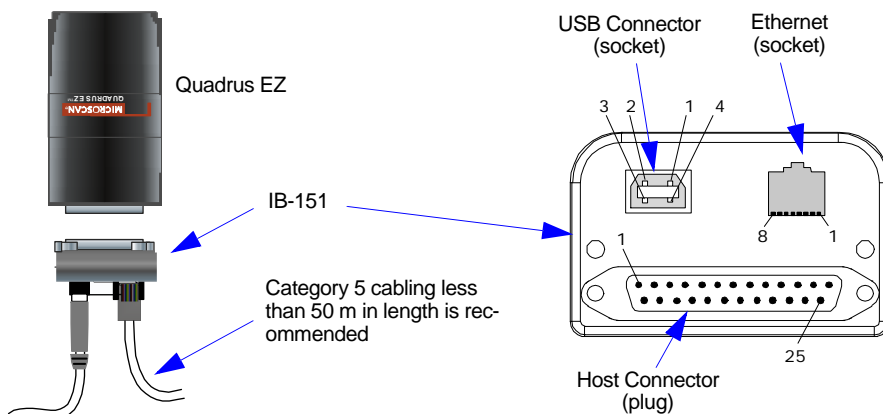

### IB-151 Ethernet

Pin	Ethernet Port
1	Ethernet TX (+)
2	Ethernet TX (-)
3	Ethernet RX (+)
4	NC
5	NC
6	Ethernet RX (-)
7	NC
8	NC

### IB-151 USB

Pin	USB Port
1	+5VDC
2	Data (-)
3	Data (+)
4	GND

### IB-151 Host

Pin	Host Port <sup>a</sup>
13	NC
14	NC
16	NC
19	NC

a. All other pins are as shown on the reader port of the IB-150.

## Important Notes

For ethernet connection, the IB-151 is recommended for the following reasons:

- Protection components are installed within the IB-151 to address ethernet susceptibility to line transients and electrostatic discharge (ESD) that can cause communication dropouts and connection termination.
- The IB-150's matching cable does not provide the proper matched impedance that the standard CAT 5 cable provides, thus allowing higher emission levels which exceed Class A CE limits and possible further signal degradation.

## IB-152 Terminal Strip Interface Kit

Custom terminal strip wiring can be done through the IB-152 interface, which can either connect directly to the Quadrus EZ or indirectly by way of the aux port of the IB-150.

**Note:** The IB-152 kit includes a gender changer. The gender changer is only used for direct connection between the IB-152 and the Quadrus EZ.

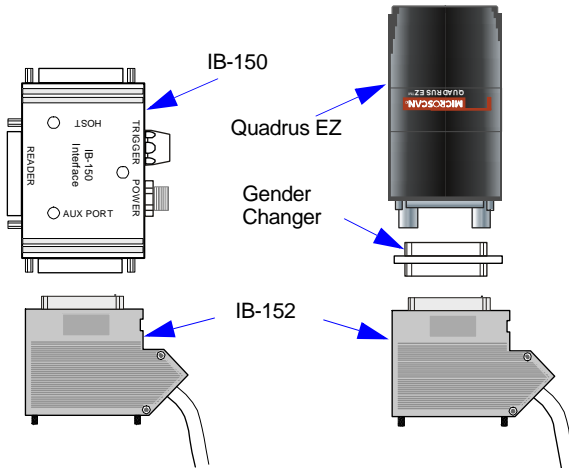

**Note:** Inside terminal assembly can be flipped over as required by application.

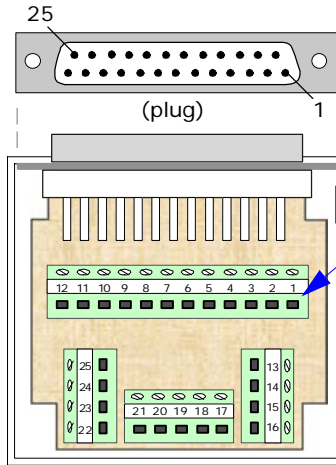

### Steps for wiring the IB-152 Interface:

1. Remove two screws from top case at these locations.
2. Pry at this point to separate cases
3. Connect external wires to terminal connections as marked. (See host or aux port pinouts on IB-150.)

## Appendix F — Serial Configuration Commands

The following table is a summary of all the available serial configuration commands, presented in the order found in the chapters.

### Serial Configuration Commands

<b>Communications</b>	
Host Port Connections	< <b>K100</b> , baud rate, parity, stop bits, data bits>
Host Port Protocol	< <b>K140</b> , protocol>
Host 232/422 Status	< <b>K102</b> , host 422>
Auxiliary Port	< <b>K101</b> , aux port mode, baud rate, parity, stop bits, data bits, daisy chain ID status, daisy chain ID>
Daisy Chain Autoconfigure	< <b>K150</b> DAISY>
Daisy Chain ID	< <b>K151</b> , daisy chain reader #, daisy chain reader ID>
Ethernet Configuration	< <b>K125</b> , IP address, subnet address, gateway address, IP address mode, primary TCP port, video TCP port>
Preamble	< <b>K141</b> , status, preamble characters>
Postamble	< <b>K142</b> , status, postamble characters>
Response Timeout	< <b>K143</b> , response timeout>
LRC	< <b>K145</b> , status>
Aux Port System Data Status	< <b>K146</b> , aux port system data>
<b>Read Cycle</b>	
Multisymbol	< <b>K222</b> , number of symbols, multisymbol separator>
Trigger Mode/Duration	< <b>K200</b> , trigger mode, trigger filter duration>
External Trigger State	< <b>K202</b> , external trigger state>
Serial Trigger Character	< <b>K201</b> , serial trigger character>
Start Trigger Character	< <b>K229</b> , start character>
Stop Trigger Character	< <b>K230</b> , stop character>
End of Read Cycle	< <b>K220</b> , end of read cycle, read cycle timeout>
Active Camera	< <b>K240</b> , active camera>
Captures	< <b>K241</b> , capture mode, number of captures, rapid capture mode>
Capture Timing	< <b>K242</b> , time before 1st capture, time between capture 1 and 2, , , , , , , time between capture 7 and 8>
Dual Camera Operations	< <b>K243</b> , switching mode, number of internal camera captures, number of external camera captures, internal camera timeout, external camera timeout>
Store Noread Image	< <b>K244</b> , image storage type, image storage mode>

<b>Symbologies</b>	
Data Matrix	<K479,ECC 200 status,ECC 000 status,ECC 050 status,ECC 080 status,ECC100 status,ECC140 status,ECC 120 status,ECC 130 status>
QR Code	<K480,status>
Code 39	<K470, status,check digit status,check digit output status,large intercharacter gap,fixed symbol length status,fixed symbol length,full ASCII set>
Code 128	<K474,status,fixed symbol length status,fixed symbol length>
BC412	<K481, status,check digit output,fixed symbol length status,fixed symbol length>
Interleaved 2 of 5	<K472, status,check digit status,check digit output,symbol length #1,symbol length #2,guard bar>
UPC/EAN	<K473,UPC status,EAN status,supplementals status,separator status,separator character,supplemental type>
Pharmacode	<K477,status,fixed symbol length status,fixed symbol length,min. no. of bars,bar width status,direction,fixed threshold value>
DataBar Expanded	<K484, status,fixed symbol length status,fixed symbol length>
DataBar Limited	<K483,status>
DataBar-14	<K482,status>
PDF417	<K476,status,[unused],fixed symbol length status,fixed symbol length,[unused],codeword collection>
Micro PDF417	<K485,status,[usused],fixed symbol length status,fixed symbol length>
Composite	<K453,mode,separator status,separator>
Narrow Margins/ Symbology ID	<K450,narrow margins,symbology identifier status>
Background Color	<K451, background color>
Unique Item Identifiers (UII)	<K455,status,errstatus>

<b>I/O Parameters</b>	
Symbol Data Output	<K705,symbol data output status,when to output>
Noread Message	<K714,noread message status,noread message>
Bad Symbol Message	<K715,[unused],message>
No Symbol Message	<K716,[unused],message>
1D/Stacked Symbology Qualification	<K717,minimum number of bars,minimum number of qualified scans,start/stop status>

2D Symbology Qualification	< <b>K718</b> , finder pattern status, symbol size mode, symbol size 1, symbol size 2, symbol size tolerance, dimension mode, dimension 1, dimension 2, dimension tolerance, orientation mode, orientation value>
Read Duration Output	< <b>K706</b> , status, separator>
LED Indicators	< <b>K750</b> , green flash mode, x-pattern status, green flash duration>
Beeper	< <b>K702</b> , beeper status>
LED Configuration	< <b>K737</b> , LED mode, ISO/IEC 15415 grade, DPM grade>
Serial Verification	< <b>K701</b> , serial command echo status, serial command beep status, control/hex output>
Video Output	< <b>K760</b> , video output mode, trigger image mode, image frame>
Image Output	< <b>K739</b> , image output mode, comm port, file format, JPEG quality>
Image Captioning	< <b>K762</b> , mode>
Synchronous Trigger	< <b>K761</b> , synchronous trigger mode>
EZ Button	< <b>K770</b> , global status, default on power-on, load IP database, save for power-on>
EZ Button Modes	< <b>K771</b> , position 1 mode, position 2 mode, position 3 mode, position 4 mode>
Input 1	< <b>K730</b> , input mode, active state>
Output 1 Parameters	< <b>K810</b> , output on, active state, pulse width, output mode>
Trend Analysis Output 1	< <b>K780</b> , trend analysis mode, number of triggers, number to output on>
Symbol Quality (ISO/IEC 15415) to Output 1	< <b>K800</b> , output on symbol contrast, symbol contrast threshold, output on print growth, print growth threshold, output on axial non-uniformity, axial non-uniformity threshold, output on unused ecc, unused ecc threshold>
Symbol Quality (Inkjet/Direct) to Output 1	< <b>K820</b> , output on dot center offset, dot center offset, output on cell fill, cell fill, output on dot ovality, dot ovality threshold, output on angle of distortion, angle of distortion threshold>
Diagnostic Warnings to Output 1	< <b>K790</b> , over temp, service unit, external camera disconnect>
Output 2	< <b>K811</b> , output on, active state, pulse width, output mode>
Trend Analysis Output 2	< <b>K781</b> , trend analysis mode, trigger evaluation period, number to output on>
Symbol Quality (ISO/IEC 15415) to Output 2	< <b>K801</b> , output on symbol contrast, symbol contrast threshold, output on print growth, print growth threshold, output on axial non-uniformity, axial non-uniformity threshold, output on unused ecc, unused ecc threshold>
Symbol Quality (Inkjet/Direct) to Output 2	< <b>K821</b> , output on dot center offset, dot center offset, output on cell fill, cell fill, output on dot ovality, dot ovality threshold, output on angle of distortion, angle of distortion threshold>
Diagnostic Warnings to Output 2	< <b>K791</b> , over temp, service unit, external camera disconnect>

## Serial Configuration Commands

<b>Symbol Quality</b>	
Total Read Time (global)	<K710, [not changed in this context], total read time>
Symbol Quality Separator/ Data Matrix Output Mode	<K708, symbol quality separator, data matrix output mode>
ISO/IEC 15415 Symbol Quality	<K709, symbol contrast, print growth, axial nonuniformity, unused ecc>
Grading Symbol Quality	<K710, percent cell damage, [see Total Read Time above], capture time, locate time, decode time, pixels per element, ecc level, matrix size, quiet zone>
<b>Matchcode</b>	
Matchcode Type	<K223, type, sequential matching, match start position, match length, wild card character, sequence on noread, sequence on mismatch>
Sequence Step	<K228, sequence step>
New Master Pin	<K225, status>
Number of Master Symbols	<K224, number of master symbols>
Enter Master Symbol Data	<K231, master symbol number, data>
Read Next Symbol as Master Symbol	<G master symbol number>
Request Master Symbol Data	<K231?,> [for all] or <K231?, master symbol number>
Delete Master Symbol Data	<K231, master symbol number, >
<b>Diagnostics</b>	
Power-on/Reset Counts	<K406, power-on, resets, power-on saves, customer default saves>
External Camera Mes- sage	<K410, disconnect msg status, disconnect message, connect msg status, control message>
Over Temperature Mes- sage	<K402, over temperature status, warning message>
Service Message	<K409, status, service message, threshold, resolution>
<b>Camera</b>	
Region of Interest	<K516, top, left, height, width>
CCD Image Sensor	<K540, shutter speed, gain>
CMOS Image Sensor	<K541, shutter speed, gain, contrast, offset>
Illumination Source	<K535, illumination source>
Thresholding	<K512, threshold mode, threshold value>
Image Processing Mode	<K513, processing mode>
Multiple Symbols in Fast Linear Mode	<K518, number of symbols>



Image Processing Timeout	<K245,image processing timeout>
Hollow Mode	<K517,hollow status>
<b>Output Format</b>	
Format Extract	<K740,output index,start location,length>
Format Insert	<K741,output index,length,hex string>
Format Assign	<K742,symbol number,status>
Format Status	<K743,output format status>
Output Filter Configuration	<K744,filter number,symbology type,length,wildcard,placeholder,data,unused,database index>
Ordered Output Filter	<K745,number of filters>
Format Extract	<K740,output index,start location,length>

## Serial Command Format

Serial commands are of two types: utility and configuration.

### Rules that apply to both utility and configuration commands

- A less than < and greater than > characters enclose the commands.
- Commands and data are “case sensitive.” That is, characters must be entered as upper or lower case, as specified.

### Serial Utility Commands

These are sent during operations and are not followed by a <A> or <Z>.

### Serial Configuration “K” Commands

These begin with a single **K** character followed by a 3-digit numeric character, data fields, and an initializing command, as follows:

<Knumeric parameter,data,data,...etc.><initializing command>

An initializing command <A> or <Z> may follow the command. A <Z> initializes the reader’s memory and saves for power-on; an <A> initializes the reader’s memory but does not save for power-on.

For example, to enable **UPC** and save the change for power-on, send <K473,1><Z>.

To change **Baud Rate** and reset without saving changes for power-on, send <K100,3><A>.

### Serial Configuration Command Conventions

- All data fields (except the last) must be followed by a comma (without a space).
- The following characters cannot be used: , < > **NULL**.
- All fields preceding a modified field must be included.
- If there is no change in preceding fields, then commas alone can be entered in these fields. For example, if only the last field in the following command is changing, <K100,4,1,0,0> can be entered as <K100,,,,0>.
- All fields *following* a modified field can be omitted. For example, to change **Baud Rate** only, send <K100,3>.

### Concatenating Configuration Commands

Commands can be concatenated (added together) in a single string or data block. For example, <K145,1><K220,1><K450,1><A> enables LRC, sets **End of Read Cycle** mode to **New Trigger**, enables **Narrow Margins**, and resets the data buffers (without saving the changes for power-on).

## Serial Command Status Request

To ensure that any command was received and accepted, you can send the **Show Reader Status** command: **<?>**.

The status of a specific serial command can be requested by entering the command followed by a question mark. For example, send **<K142?>** to request the status of **Postamble**.

## Entering Special Characters in Serial Commands

To enter control characters within a serial command, hold down the control key while typing the desired character.

Example: To enter a carriage return and line feed (**^M^J**), enter **<K141,1,CNTL-m CNTL-j>**

## Entering Special Characters in Embedded Menus

### **Control Characters**

Control characters entered on the command line are displayed in the menu as mnemonic characters, such as: **<CR><LF><NUL><NUL>**.

Press **SP** (the space bar) once, then enter the control character by holding down the control key and simultaneously pressing the desired character. For example to define a line feed, press **SP**, then **Control** and **J** simultaneously. It is displayed as **^J** on the command line and as **<LF>** in the menu when the screen is refreshed.

### **To Define a Carriage Return as a Character**

Press **SP**, then **CR**. It is displayed as **^M** on the command line and as **<CR>** in the menu when the screen is refreshed.

### **To Define a Space as a Character**

Press **SP** twice. It is displayed as a blank space in the menu when the screen is refreshed. While it appears that nothing has been assigned, the hex value **20** will be sent during data transmission.

### **To Select NUL as the Character**

Press **SP**, then a **0** (zero). It is displayed as **<NUL>** in the menu when the screen is refreshed.

# Appendix G — ASCII Table

## ASCII Table with Control Characters

Dec	Hex	Mne	Ctrl	Dec	Hex	Ch	Dec	Hex	Ch	Dec	Hex	Ch
00	00	NUL	^@	32	20	SP	64	40	@	96	60	`
01	01	SOH	^A	33	21	!	65	41	A	97	61	a
02	02	STX	^B	34	22	"	66	42	B	98	62	b
03	03	ETX	^C	35	23	#	67	43	C	99	63	c
04	04	EOT	^D	36	24	\$	68	44	D	100	64	d
05	05	ENQ	^E	37	25	%	69	45	E	101	65	e
06	06	ACK	^F	38	26	&	70	46	F	102	66	f
07	07	BEL	^G	39	27	'	71	47	G	103	67	g
08	08	BS	^H	40	28	(	72	48	H	104	68	h
09	09	HT	^I	41	29	)	73	49	I	105	69	i
10	0A	LF	^J	42	2A	*	74	4A	J	106	6A	j
11	0B	VT	^K	43	2B	+	75	4B	K	107	6B	k
12	0C	FF	^L	44	2C	,	76	4C	L	108	6C	l
13	0D	CR	^M	45	2D	-	77	4D	M	109	6D	m
14	0E	SO	^N	46	2E	.	78	4E	N	110	6E	n
15	0F	SI	^O	47	2F	/	79	4F	O	111	6F	o
16	10	DLE	^P	48	30	0	80	50	P	112	70	p
17	11	DC1	^Q	49	31	1	81	51	Q	113	71	q
18	12	DC2	^R	50	32	2	82	52	R	114	72	r
19	13	DC3	^S	51	33	3	83	53	S	115	73	s
20	14	DC4	^T	52	34	4	84	54	T	116	74	t
21	15	NAK	^U	53	35	5	85	55	U	117	75	u
22	16	SYN	^V	54	36	6	86	56	V	118	76	v
23	17	ETB	^W	55	37	7	87	57	W	119	77	w
24	18	CAN	^X	56	38	8	88	58	X	120	78	x
25	19	EM	^Y	57	39	9	89	59	Y	121	79	y
26	1A	SUB	^Z	58	3A	:	90	5A	Z	122	7A	z
27	1B	ESC	^[	59	3B	;	91	5B	[	123	7B	{
28	1C	FS	^\	60	3C	<	92	5C	\	124	7C	
29	1D	GS	^]	61	3D	=	93	5D	]	125	7D	}
30	1E	RS	^^	62	3E	>	94	5E	^	126	7E	~
31	1F	US	^_	63	3F	?	95	5F	_	127	7F	D

## Communication Protocol Commands

<b>Protocol Command (Mnemonic displayed on Microscan menu)</b>	<b>Control Characters (Entered in menu or serial command)</b>	<b>Hex Code</b>	<b>Effect of Command</b>
RES	^D	04	Reset
REQ	^E	05	Request
EOT	^D	04	Reset
STX	^B	02	Start of Text
ETX	^C	03	End of Text
ACK	^F	06	Acknowledge
NAK	^U	15	Negative Acknowledge
XON	^Q	11	Begin Transmission
XOFF	^S	13	Stop Transmission

# Appendix H — Data Matrix Symbology

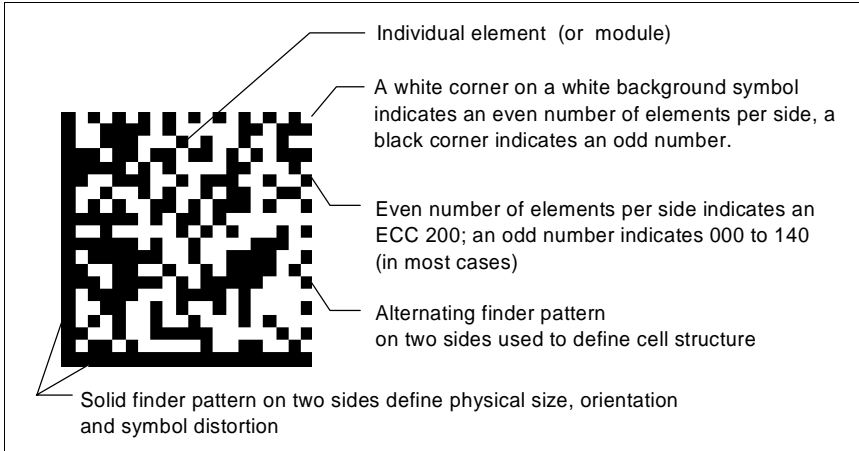

## Data Matrix Symbol Comparison

<b>Symbol Features</b>	<b>ECC 000 - 140</b>	<b>ECC 200</b>
Number of rows and columns (including finder pattern)	Odd (except for some closed applications)	Even
Element in upper right hand corner	Dark (for light background symbols)	Light (for light background symbols)
Error correction routine	Convolution	Reed-Solomon
Symbol sizes (not including quiet zones)	17 to 21 sizes (squares only)	24 squares 6 rectangular
Append in structured format	No	Yes, up to 16 symbols
Subdivide code word stream into blocks for error detection	No	Yes, for symbols with more than 255 code words
Extended channel interpretation for other character sets	No	Yes, optional
Data encoded in:	Base 11, 27, 41, 37, ASCII, 8-bit Byte	ASCII, C40, text, X12, EDIFACT, and Base 256

## Appendix I — Determine Depth of Field

If symbols appear in the FOV at a consistent distance in your application, you could simply set up for the recommended focal length and omit this test. However, if your symbols appear at varying focal lengths, we recommend that you perform the following test to determine the inner and outer read distances for your symbol type.

1. Position the symbol at the focal distance recommended on the back of your reader.
2. Position the symbol relative to the reader so that the distance to the reader can be shortened or extended. Ideally, you should have the symbol mobile and the reader mounted on a stand.
3. Move the symbol towards the reader and away from the reader until the decode rate and/or green LED light drops off in each direction as shown in the illustration on the right.

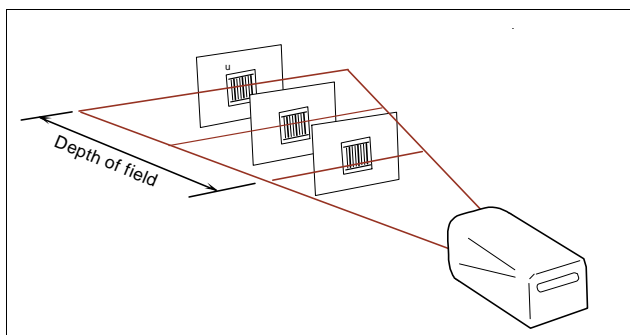

This will give you a sense of the depth of field (inner and outer ranges) for your symbol's density and focal distance.

**Note:** Depth of field will vary according to lens type. Typically, the narrow and medium lens type readers will have less depth of field than the wide and extra wide readers.

## Appendix J — Field of View and Lenses

Representations of two lens type views are shown in the drawing below. Notice that while FOVs vary considerably by lens type and focal distance (the distance from the front of the reader—also called “object distance”), the image sensor sizes are fixed. This is the case with the both the CMOS and CCD which use the same sensor size for all lens types.

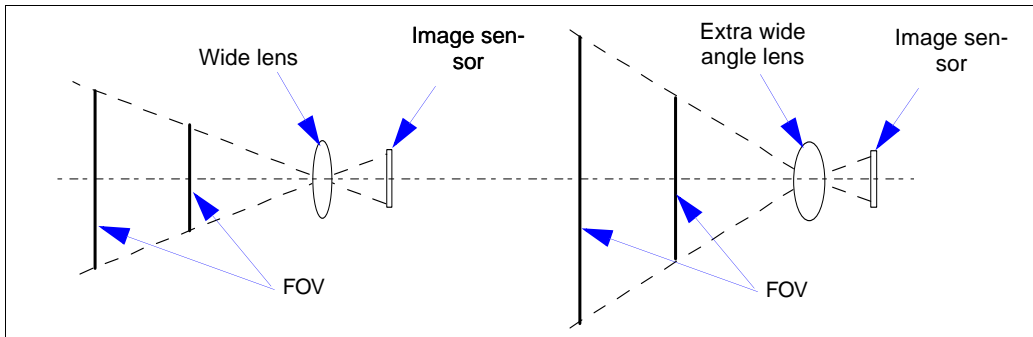

### Pixels and Resolution

Wider lenses mean a wider FOV, but lower resolutions. This is because the number of pixels on the image sensor, whether CCD or CMOS, is the same for all lens types. So if you increase the FOV—by going to a larger lens type or a longer focal distance—the resolution (the number of pixels available for a given area) diminishes. In the representations to the right, the extra-wide lens has the same number of pixels available as the wide angle at similar distances, but since the wide angle’s FOV is about half that of the extra-wide’s FOV, its resolution is therefore double.

Wide angle lens

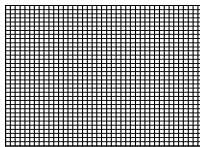

Extra-wide angle lens

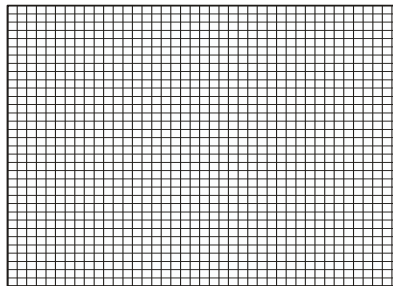

This can be stated in two rules:

1. At any given focal distance, the smaller the lens type, the higher the resolution.
2. For any given lens type, the shorter the focal distance, the higher the resolution.



## Relative Sizes of FOVs by Lens Type at 4” Focal Distance

Note: FOV representations are approximate and should not be used for actual measurement.

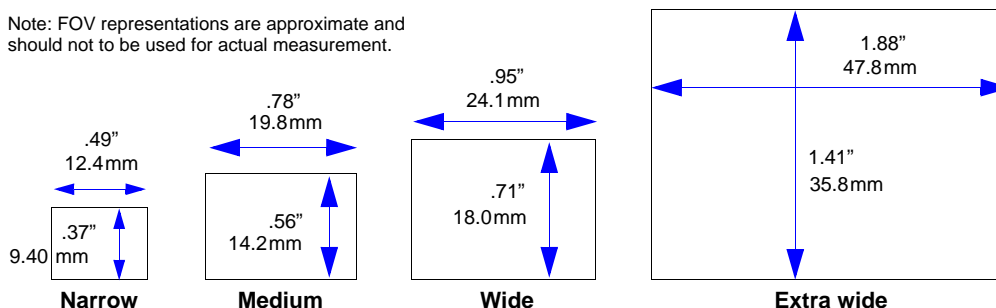

## Quadrus EZ Maximum 2D Symbol Sizes

Maximum Element Sizes by Lens Type at 4” (101.6mm) Focal Distance

		Lens Type			
Field of View		Narrow	Medium	Wide	Extra Wide
X-dimension		.49" (12.4mm)	.78" (19.8mm)	.95" (24.1mm)	1.88" (47.8mm)
Y-dimension <sup>a</sup>		.37" (9.40mm)	.56" (14.2mm)	.71" (18.0mm)	1.41" (35.8mm)
Symbol	Adjusted Y <sup>b</sup>	.355" (9.0mm)	.538" (13.7mm)	.68" (17.3mm)	1.35" (34.3mm)
.005" (.127mm)	Aligned to FOV	64 x 64			
	Rotated <sup>c</sup>	48 x 48			
.0075 (.191mm)	Aligned to FOV		64 x 64	88 x 88	
	Rotated		48 x 48	64 x 64	
.010 (.254mm)	Aligned to FOV			64 x 64	
	Rotated			48 x 48	
.015 (.381mm)	Aligned to FOV				88 x 88
	Rotated				64 x 64

- The Y-dimension = X-dimension x 75%.
- A 20 pixel combined top and bottom buffer (96%) around the symbol is the adjusted Y-dimension.
- When 2D symbols are rotated 45°, their maximum Y-dimension is divided by 1.41 to assure readability.

### Notes:

- Dynamic symbols that are close in size to the maximum field of view limitations may prove difficult to read unless their vertical placements are precisely controlled.
- Good read opportunities are enhanced in Rapid Capture mode by ensuring the maximum number of Rapid Captures occur while the symbol is in the field of view.

*Field of View and Lenses*

*CCD Focal Distance, FOV, DOF and Symbol Size by Lens Type*

Focal Distance		Field of View		Depth of Field		Symbol Element Size	
Inches	mm	Inches	mm	Inches	mm	Inches	mm
<b>Narrow Lens</b>							
3.50	88.9	0.33	8.4	0.20	5.1	0.0050	0.127
3.75	95.3	0.39	9.9	0.20	5.1	0.0050	0.127
4.00	101.6	0.44	11.2	0.20	5.1	0.0050	0.127
4.25	108.0	0.49	12.4	0.20	5.1	0.0050	0.127
4.50	114.3	0.55	14.0	0.20	5.1	0.0050	0.127
4.75	120.7	0.59	15.0	0.40	10.2	0.0075	0.191
5.00	127.0	0.65	16.5	0.40	10.2	0.0075	0.191
<b>Medium Lens</b>							
2.25	57.2	0.44	11.2	0.10	2.5	0.0050	0.127
3.00	76.2	0.59	15.0	0.50	12.7	0.0075	0.191
3.50	88.9	0.68	17.3	0.50	12.7	0.0075	0.191
4.00	101.6	0.77	19.6	0.50	12.7	0.0075	0.191
5.00	127.0	0.94	23.9	1.00	25.4	0.0100	0.254
6.00	152.4	1.12	28.4	1.00	25.4	0.0100	0.254
7.00	177.8	1.30	33.0	2.20	55.9	0.0150	0.381
8.00	203.2	1.49	37.8	2.50	63.5	0.0150	0.381
9.00	228.6	1.63	41.4	2.60	66.0	0.0150	0.381
10.00	254.0	1.78	45.2	4.20	106.7	0.0200	0.508
<b>Wide Lens</b>							
2.00	50.8	0.49	12.4	0.10	2.5	0.0050	0.127
3.00	76.2	0.72	18.3	0.50	12.7	0.0075	0.191
4.00	101.6	0.93	23.6	1.00	25.4	0.0100	0.254
5.00	127.0	1.13	28.7	2.00	50.8	0.0150	0.381
6.00	152.4	1.35	34.3	2.20	55.9	0.0150	0.381
7.00	177.8	1.56	39.6	2.80	71.1	0.0150	0.381
8.00	203.2	1.76	44.7	4.20	106.7	0.0200	0.508
9.00	228.6	1.96	49.8	4.20	106.7	0.0200	0.508
10.00	254.0	2.17	55.1	4.80	121.9	0.0200	0.508
<b>Extra Wide Lens (for 2D symbols)</b>							
2.50	63.5	1.26	32.0	1.00	25.4	0.0150	0.381
3.00	76.2	1.45	36.8	1.00	25.4	0.0150	0.381
4.00	101.6	1.84	46.7	1.00	25.4	0.0150	0.381
5.00	127.0	2.22	56.4	2.00	50.8	0.0200	0.508
6.00	152.4	2.58	65.5	3.60	91.4	0.0300	0.762
7.00	177.8	2.94	74.7	4.20	106.7	0.0300	0.762
8.00	203.2	3.33	84.6	4.20	106.7	0.0300	0.762
9.00	228.6	3.70	94.0	5.80	147.3	0.0400	0.1016
10.00	254.0	4.18	106.2	6.00	152.4	0.0400	0.1016
<b>Extra Wide Linear Lens (for linear symbols)</b>							
2.50	63.5	1.26	32.0	0.60	15.2	0.0075	0.191
3.00	76.2	1.45	36.8	1.10	27.9	0.0100	0.254
4.00	101.6	1.84	46.7	1.40	35.6	0.0100	0.254
5.00	127.0	2.20	55.9	2.80	71.1	0.0150	0.381
6.00	152.4	2.60	66.0	3.00	76.2	0.0150	0.381
7.00	177.8	2.96	75.2	3.80	96.5	0.0200	0.508
8.00	203.2	3.33	84.6	3.80	96.5	0.0200	0.508
9.00	228.6	3.73	94.7	5.00	127.0	0.0200	0.508
10.00	254.0	4.14	105.2	6.80	172.7	0.0300	0.762

CMOS Focal Distance, FOV, DOF and Symbol Size by Lens Type

Focal Distance		Field of View		Depth of Field		Symbol Element Size	
Inches	mm	Inches	mm	Inches	mm	Inches	mm
<b>Narrow Lens</b>							
3.50	88.9	0.34	8.6	0.10	2.5	.005	0.127
3.75	95.3	0.40	10.2	0.10	2.5	.005	0.127
4.00	101.6	0.46	11.7	0.10	2.5	.005	0.127
4.25	108.0	0.51	13.0	0.10	2.5	.005	0.127
4.50	114.3	0.56	14.2	0.10	2.5	.005	0.127
4.75	120.7	0.61	15.5	0.20	5.1	.0075	0.191
5.00	127.0	0.67	17.0	0.20	5.1	.0075	0.191
<b>Medium Lens</b>							
2.25	57.2	0.24	6.1	0.10	2.5	.005	0.127
3.00	76.2	0.60	15.2	0.20	5.1	.0075	0.191
4.00	101.6	0.80	20.3	0.50	12.7	.0075	0.191
5.00	127.0	0.98	24.9	0.80	20.3	.010	0.254
6.00	152.4	1.16	29.5	1.80	45.7	.015	0.381
7.00	177.8	1.32	33.5	2.00	50.8	.015	0.381
8.00	203.2	1.50	38.1	2.00	50.8	.015	0.381
9.00	228.6	1.70	43.2	3.40	86.4	.020	0.508
10.00	254.0	1.86	47.2	3.40	86.4	.020	0.508
<b>Wide Lens</b>							
2.00	50.8	0.50	12.7	0.10	2.5	.005	0.127
3.00	76.2	0.75	19.1	0.50	12.7	.0075	0.191
4.00	101.6	0.98	24.9	1.00	25.4	.010	0.254
5.00	127.0	1.17	29.7	1.80	45.7	.015	0.381
6.00	152.4	1.40	35.6	2.20	55.9	.015	0.381
7.00	177.8	1.60	40.6	3.40	86.4	.020	0.508
8.00	203.2	1.82	46.2	3.60	91.4	.020	0.508
9.00	228.6	1.99	50.5	3.60	91.4	.020	0.508
10.00	254.0	2.26	57.4	6.00	152.4	.030	0.762
<b>Extra Wide Lens</b>							
2.50	63.5	1.09	27.7	1.00	25.4	.015	0.381
3.00	76.2	1.46	37.1	1.00	25.4	.015	0.381
4.00	101.6	1.88	47.8	1.00	25.4	.015	0.381
5.00	127.0	2.27	57.7	2.20	55.9	.020	0.508
6.00	152.4	2.64	67.1	3.80	96.5	.030	0.762
7.00	177.8	3.05	77.5	5.00	127.0	.030	0.762
8.00	203.2	3.47	88.1	5.20	132.1	.030	0.762
9.00	228.6	3.83	97.3	4.80	121.9	.030	0.762
10.00	254.0	4.24	107.7	8.00	203.2	.040	1.016

## Appendix K — Rapid Capture Mode

In rapid capture mode, from one to eight captures can be specified along with time delays between captures. In this mode the only built-in delay is the time for image capture and transfer.

After the initial capture has been transferred, decoding begins and is processed simultaneously with and independently of subsequent captures.

The key features of Rapid are:

- There is no wait between captures for processing
- From one to eight captures can be user-defined
- Time delays between captures can be individually user-defined

Rapid Capture is useful when:

- Reading sets of up to 8 symbols
- “Extending” the field of view
- In very high-speed applications
- Switching by number of captures in dual camera applications
- Precise timing and spacing are needed

### Single Capture

When you first load **ESP**, the default for capturing is **Rapid Capture** and **Number of Captures** set to 1.

This is the same as “single shot” and will work well with many moving applications. When objects are tightly spaced, **Rapid Capture** set to **Last Frame** is the preferred setup.

In the sketch to the above, a trigger is used to time the capture to occur when the symbol is in the center of the FOV.

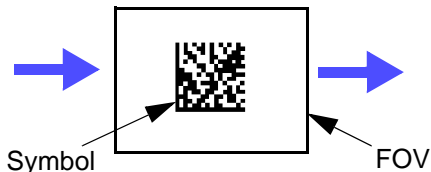

## Multiple Captures

In many applications, you can improve opportunities for good reads by increasing the number of captures.

The sketches below show dynamic multiple captures with no user-defined time delays added between them. However, since a built-in or “overhead” capture time (15mS for CCD and 30mS for CMOS) occurs after each capture, some spacing between captures will be noticeable in higher speed applications.



- An ideal setup would look like this where overlapping symbols fall within or mostly within the FOV.



- This shows an acceptable pattern where at least one symbol can be expected to fall within the FOV.

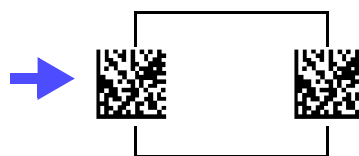

- The spacing here is not acceptable since it is too wide to guarantee that any of the symbols will fall within the FOV.

## Appendix L — Object Detector

In a typical operation, a reader will wait for symbol data only during a triggered read cycle. A read cycle is initiated by a “trigger” and can be in the form of a serial command from the host (internal trigger) or a signal from an object detector (external trigger).

When an object detector (also called a sensor, package detector, etc.) is used, it is set up so that its beam will bounce off the approaching object and the resulting pulse will be sent to the reader to begin the read cycle. Typically, a detector is positioned so that it will detect the presence of an object before its symbol can be read.

An object detector is mounted in almost any position relative to the object as long as (1) the object passes within range of the detector and (2) direct or reflected light from the detector does not interfere with the reader’s reception.

As the item continues to move down the line, its symbol moves into the reader beam and is read by the reader.

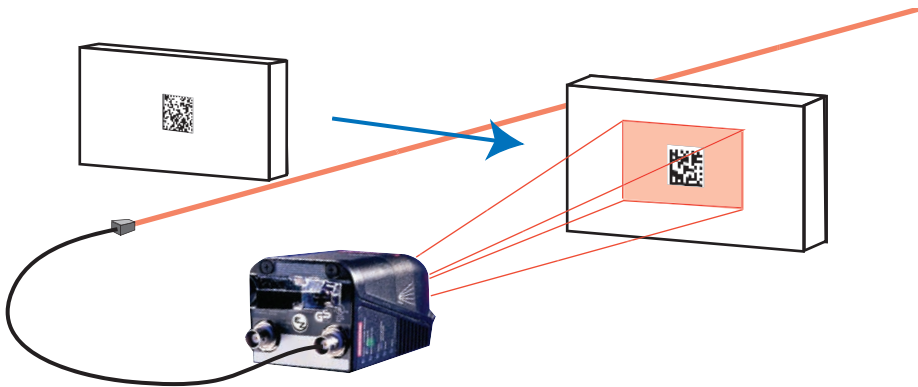

*Object Detector Operation*

## ***Appendix M — Operational Tips***

### **Cleaning**

The Quadrus EZ has a hard coated window that should only be cleaned with Alcohol (100% Isopropyl).

### **Mounting**

When mounting the Quadrus EZ, do not insulate the stand mount. The bottom of the reader is the hottest part of the reader and metal to metal contact is needed for heat dissipation.

## Appendix N — Embedded Menus

In addition to **ESP**, you can also use a communications menu such as HyperTerminal to establish communication with Microscan's embedded menus.<sup>1</sup>

1. With your host connected to the Quadrus EZ, set your host communications settings as follows: **115.2K** baud, **8** Data Bits, **1** Stop Bits, and **None** Parity.
2. Set **Flow Control** to **None**.
3. Make the communications port selection. (Usually **COM 1** for Windows OS.)

Upon connection, send a **<D>** command to bring up the main menu.

Menu navigation commands are case sensitive. Use the space bar or **N** to advance to the next item, **CR** (return key) to select a highlighted item, **B** to return to the previous item, **M** to return to the previous menu, and **ESC** to return to the Main menu or to exit the program. When exiting the program, you will be prompted to save your active settings for power up (**Y** or **N**). Typing **Y** will be equivalent to saving with a **<Z>** command.

---

1. If you are using HyperTerminal, you may find that the initial screen is not visible when you call up the program with the **<D>** command. If this occurs, exit the embedded menu with an **ESC**, **E**, and **N** sequence and repeat the **<D>** command.



---

## Appendix O — Interface Standards

Interface Standards, established by the Electronic Industries Association (EIA), specify such things as the signaling voltage levels, maximum cable lengths, and number of drivers. With Microscan devices, selection of interface is made by pin assignment and, in the case of the host communications, by software switching between RS-232 and RS-422. Microscan devices use RS-232, RS-422, and RS-485 multidrop.

### RS-232

RS-232 defines an interface between two devices such as, for example, the reader and host. It differs from the other interfaces by dedicating individual pins to specific functions and by requiring both devices to share a common ground line. Since both device chassis are connected to a common ground, a ground loop potential and the possibility of noise interference exists. Therefore cable lengths are limited to a maximum of 50 feet (19.7m). Despite being the most limited, this interface is used frequently because of the large installed base of RS-232 equipment.

### RS-422

RS-422, unlike RS-232, measures signals differentially; that is, the receiver looks at the potentials between the two receive (or transmit) wires rather than the potential between signal and ground. As a result, cables, if shielded, can be up to 4000 feet (1219m) in length. Like RS-232, RS-422 communication is designed for only two devices on a single line and must have a common ground. It can be used wherever RS-232 is used.

### RS-485

RS-485, like RS-422, can transmit up to 4000 feet (1219 m) using differential voltages but unlike RS-422, its transmitters are turned off until a request for data is received from the host. RS-485 is used exclusively in multidrop protocol.

### Ethernet

Ethernet is supported for 10Mbps per second with packets between 64 and roughly 1500 bytes in length. A 6-byte address is used, which is divided into a 3-byte vendor ID and a 3-byte vendor-defined field. Ethernet manufacturers are assigned a unique vendor ID, and are then responsible for insuring that all of their devices have unique addresses in the last 3 bytes.

# Appendix P — Multidrop Communications

This appendix describes the rules for setting up a concentrator or controller to communicate with a reader in standard Multidrop protocol.

The diagram to the right shows a typical Multidrop network in which 1 to 50 readers can communicate with a host via an intermediary device, a concentrator or a controller.

## Polling Sequence

Data that is transmitted to the host (symbol data, noread messages, counters, etc.) via concentrators is solicited by poll requests from the host.

The polling sequence example by poll address 1E (ASCII hex value for Reader 02) and a REQ (request). The reader responds by first transmitting its own address, 1E, followed by a STX (start of text) character, and then the data. Next it transmits an ETX (end of text) character and an LRC (longitudinal redundancy check) character.

If the concentrator (or controller) receives the data from the reader and is able to validate it with an LRC calculation, it responds with an ACK (acknowledgment). If the reader in turn receives the ACK, the reader ends this successful exchange with a RES (reset).

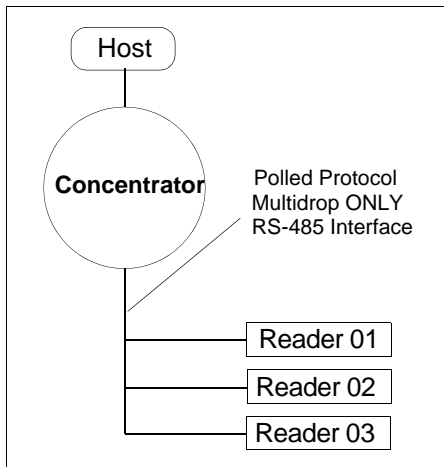

Multidrop

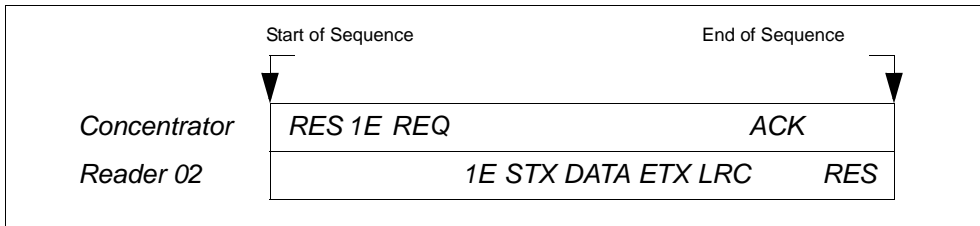

Polling Sequence

## Polling Reset

- If the reader has no information, it responds to a poll request by transmitting a RES (reset).
- If the reader receives a NAK instead of the ACK after transmitting its data string, it will re-attempt to send the data string up to three times. If the reader still does not receive an ACK, it will send a RES (reset) and discard the data in its buffers.
- If the reader transmits data to the concentrator and the concentrator responds with an ACK or NAK, but the reader doesn't receive the concentrator's response, the reader will timeout and send a REQ to the concentrator and request another response. If after three retries (the number of times it transmits a REQ to the concentrator) the reader receives no response, it ends the transmission with a RES (reset).

## Select Sequence

Unlike poll requests, select commands always originate from the host and consist of serial configuration or operation commands to devices that are configured in Multidrop. The reader complies with the command when it is polled during the cycle.

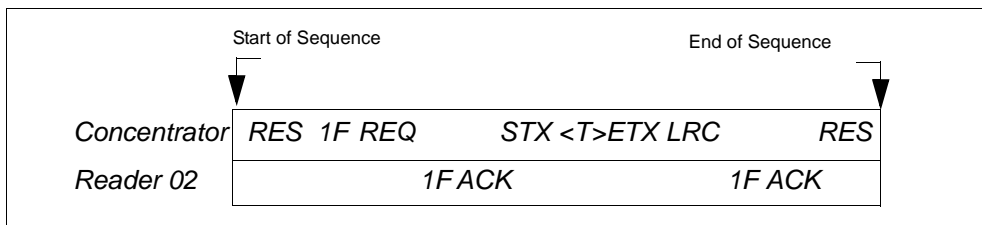

*Polling Sequence*

A RES (reset) is the first command in the select sequence. The 1F hex is the select address associated with Reader 02 address. It is followed by a REQ (request). The reader responds with its own select address, 1F hex, and an ACK (acknowledge). The concentrator then transmits an STX (start of text), the data (in this case a <T>), an ETX (end of text), and an LRC character.

The reader replies by transmitting its own address, followed by an ACK, acknowledging receipt of the command. Upon receipt of an ACK, the concentrator concludes the successful exchange with a RES.

In the example above, the reader only acknowledges a trigger counter request from the concentrator. It does not respond to the trigger counter request until a subsequent poll. For example, if the reader's trigger count was 12 at the time the trigger counter request was received, on a subsequent poll it would send 02T/00012. (The 02 at the beginning of the string is the reader's address.)

### Select Reset

If the reader receives bad data from the concentrator, it transmits a SEL (its select address) and a NAK to the concentrator. The concentrator re-transmits the data up to three times. The concentrator will end the sequence with a RES (reset) if no ACK is received.

Multidrop Communications

Multidrop Addresses

Multidrop Address	Poll Character		Select Character	
	ASCII	HEX	ASCII	HEX
01	^	1C	^]	1D
02	^^	1E	^~	1F
03	SP	20	!	21
04	"	22	#	23
05	\$	24	%	25
06	&	26	'	27
07	(	28	)	29
08	*	2A	+	2B
09	,	2C	-	2D
10	.	2E	/	2F
11	0	30	1	31
12	2	32	3	33
13	4	34	5	35
14	6	36	7	37
15	8	38	9	39
16	:	3A	;	3B
17	<	3C	=	3D
18	>	3E	?	3F
19	@	40	A	41
20	B	42	C	43
21	D	44	E	45
22	F	46	G	47
23	H	48	I	49
24	J	4A	K	4B
25	L	4C	M	4D

Multidrop Address	Poll Character		Select Character	
	ASCII	HEX	ASCII	HEX
26	N	4E	O	4F
27	P	50	Q	51
28	R	52	S	53
29	T	54	U	55
30	V	56	W	57
31	X	58	Y	59
32	Z	5A	[	5B
33	\	5C	]	5D
34	^	5E	_	5F
35	`	60	a	61
36	b	62	c	63
37	d	64	e	65
38	f	66	g	67
39	h	68	i	69
40	j	6A	k	6B
41	l	6C	m	6D
42	n	6E	o	6F
43	p	70	q	71
44	r	72	s	73
45	t	74	u	75
46	v	76	w	77
47	x	78	y	79
48	z	7A	{	7B
49		7C	}	7D
50	~	7E	D	7F

## Appendix Q — Glossary of Terms

**Aberration**—The failure of an optical lens to produce an exact point-to-point correspondence between the object and its resulting image. Various types are chromatic, spherical, coma, astigmatism and distortion.

**Absorption**—The loss of light of certain wavelengths as it passes through a material and is converted to heat or other forms of energy. (-)

**Active Illumination**—Lighting a scene with a light source coordinated with the acquisition of an image. Strobed flash tubes and pulsed lasers are examples.

**Ambient light**—Light which is present in the environment of the imaging front end of a vision system and generated from outside sources. This light, unless used for actual scene illumination, will be treated as background noise by the vision system.

**Analog**—A smooth, continuous voltage or current signal or function whose magnitude (value) is the information. From the word “analogous,” meaning “similar to.”

**Analog Gain Adjustment (AGC)**. Adjustment to signal strength that seeks to maintain a constant level regardless of the range of the bar code symbol.

**Analog-to-Digital Converter (A/D)**—A device which converts an analog voltage or current signal to a discrete series of digitally encoded numbers (signal) for computer processing. Architecture—For a vision system, the hardware organization designed for high speed image analysis.

**ASIC**—An acronym for Application Specific Integrated Circuit. All vision system elements including firmware can be integrated onto one ASIC.

**Aspect Ratio**—The ratio between the height and width of a sensor or display. It is found by dividing the vertical number of pixels (height) by the horizontal number of pixels (width) leaving it in fractional format.

**Auxiliary Port**—RS-232 connections to an auxiliary terminal or device for remote viewing. the transfer of data to and from the host, and under certain conditions a configuration port.

**Blooming**—The situation where too many photons are being produced to be received by a pixel. The pixel overflows and causes the photons to go to adjacent pixels. Blooming is similar to overexposure in film photography, except that in digital imaging, the result is a number of vertical and/or horizontal streaks appearing from the light source in the picture.

**Baud Rate**—The number of discrete signal events per second. Bits per second.

**Capture**—The act of acquiring and storing video images in a reader or computer. Also, the image captured.

**CCD**—Charged Coupled Device CCDs capture light onto an array of light-sensitive diodes, each diode representing one pixel.

**Check Digit**—A Modulus 43 or Modulus 10 digit that is added to the bar code message for additional data integrity.

**CMOS**—Complementary Metal Oxide Semiconductor. Like CCDs, CMOS readers include an array of photo-sensitive diodes, one diode within each pixel. Unlike CCDs, however, each pixel in a CMOS reader has its own individual amplifier integrated inside.

**Connector**—Physical device (plug or socket) on a device or cable to provide in/out connectivity for various circuits and pins.

**Concentrator**—Intermediary device that relays data from readers to a host and commands from the host to the reader or other devices.

**Counter**—Memory space provided to keep track of reader events.

**Daisy Chain**—Linkage of master and secondary readers to allow data to be relayed up to the host via auxiliary port connections.

**Decode**—A good read. The successful scanning and decoding of the information encoded in a bar code symbol.

**Default**—Restores ROM or Flash settings, initializes serial commands and resets all counters.

**Delimited**—A command or field that is bracketed by pre-defined characters.

**Decode Rate**—The number of good reads per second decoded by the reader.

**Darkfield Illumination**—Lighting of objects, surfaces or particles at very shallow or low angles, so that light does not directly enter the optics.

**Depth-of-Field**—The in-focus range of an imaging system. Measured from the distance behind an object to the distance in front of the object with all objects appearing in focus.

**Diffused lighting**—Scattered soft lighting from a wide variety of angles used to eliminate shadows and specular glints from profiled, highly reflective surfaces.

**Digital-to-Analog Converter**—A VLSI circuit used to convert digital computer processed images to analog for display on a monitor. DAC is the acronym.

**Digital Imaging**—Conversion of a video picture into pixels by means of an A/D converter where the level of each pixel can be stored in a computer.

**Digital Signal Processor (DSP)**—A VLSI chip designed for ultra high speed arithmetic processing. Often imbedded in a vision engine. TI's TMS320C40 is the industry standard.

**Discrete I/O**—Inputs and outputs characterized by discrete signal transitions from one voltage level to another so that digital switching can occur.

**DMA**—Direct Memory Access. A capability provided by some computer bus architectures that allows data to be sent directly from an attached device (such as a disk drive) to memory.

**DSP**—Digital Signal Processing

**Dynamic Range**—The difference between the minimum and maximum thresholds of discernible images; the amount of usable signal.

**Edge Enhancement**—Image processing method to strengthen high-spatial frequencies in the image.

**EPROM**—Erasable, programmable, read only memory.

**Embedded Memory**—Onboard memory device such as EPROM or flash.

**End of Read Cycle**—The time or condition at which the reader stops expecting symbol information to decode.

**External Edge**—Allows a read cycle to be initiated by a trigger signal from an object detector when it detects the appearance of an object (rising edge). The read cycle ends with a good read, a timeout, or a new trigger.

**External Level**—Allows a read cycle to be initiated by a trigger signal from an object detector. The read cycle ends when the object moves out of the detector's range.

**Falling Edge**—A change of state (to inactive) associated with a level trigger in which **Fill Factor**—Percentage of pixel area used for light collection.

**Firmware**—Software hard-coded in non-volatile memory (ROM).

**Fixed Code Length**—Increases data integrity by ensuring that only one symbol length will be accepted.

**Focal Distance**—In camera-based vision, the distance from the front of the camera to the object being viewed. (In optics, the distance from the lens to the focal plane.)

**Focal Plane**—Usually found at the image sensor, it is a plane perpendicular to the lens axis at the point of focus (-).

**Focus**—The point at which rays of light converge for any given point on the object in the image. Also called the focal point.

**Frame**—The total area scanned in an image sensor while the video signal is not blanked.

**Frame Grabber**—A device that interfaces with a camera and, on command, samples the video, converts the sample to a digital value and stores that in a computer's memory.

**Front End System**—The object, illumination, optics and reader blocks of a vision system. Includes all components useful to acquire a good image for subsequent processing.

**FPGA**—A field-programmable gate array.

**Gain**—The amount of energy applied to the pixel gray scale values prior to output, expressed in dB; optimal signal strength.

**Good Read**—A decode. The successful scanning and decoding of the information encoded in a bar code symbol.

**Gradient**—The rate of change of pixel intensity (first derivative).

**Gray Scale**—Variations of values from white, through shades of gray, to black in a digitized image with black assigned the value of zero and white the value of one.

**Half Duplex**—Auxiliary port data is sent directly to the host and displayed on the auxiliary port screen.

**Histogram**—A graphical representation of the frequency of occurrence of each intensity or range of intensities (gray levels) of pixels in an image. The height represents the number of observations occurring in each interval.

**Host**—A computer, PLC, or other device that is used to execute commands and process data and discrete signals.

**Image**—Projection of an object or scene onto a plane (i.e. screen or image sensor).

**Image Processing**—Transformation of an input image into an output image with desired properties.

**Image sensor**—Array of pixels on a CCD or CMOS sensor.

**Initialize**—Implement serial configuration commands into the reader's active memory.

**Input**—A channel or communications line. Decoded data or a discrete signal that is received by a device. See **Output**.

**Integration**—Exposure of pixels on a CCD or CMOS sensor.

**Ladder Orientation**—A bar code symbol in which the bars are parallel to the symbol's direction of travel.

**LED**—Light emitting diode. Often used as a strobe for medium speed objects.

**Lens**—A transparent piece of material with curved surfaces which either converge or diverge light rays.

**Machine Vision**—The automatic acquisition and analysis of images to obtain desired data for controlling a specific activity.

**Multidrop**—A communications protocol for networking two or more readers or other devices with a concentrator (or controller) and characterized by the use of individual device addresses and the RS-485 standard.

**Noise**—The same as static in a phone line or "snow" in a television picture, noise is any unwanted electrical signal that interferes with the image being read and transferred by the reader.

**Normally Closed**—A discrete output state that is only active when open.

**Normally Open**—A discrete output state that is only active when closed.

**Object Plane**—An imaginary plane at the object, which is focused by the optical system at the image plane on the sensor.

**Output**—A channel or communications line. Data or discrete signals that are transmitted or displayed by a device.

**Parity**—An error detection routine in which one data bit in each character is set to 1 or 0 (zero) so that the total number of 1 bits in the data field is even or odd.

**Picket Fence Symbol Orientation**—A bar code symbol in which the bars are perpendicular to the symbol's direction of travel.

**Pixel**—Acronym for picture element. The individual elements in a digitized image array.

**Port**. Logical circuit for data entry and exit. (One or more ports may be included within a single connector.)

**Processing Time**—The time used by a vision system to receive, analyze and interpret image information. Often expressed in parts per minute.

**Progressive Scan**—A non-interlaced scan that doubles the number of visible picture lines per field by displaying all picture lines at once.

**Protocol**. The rules for communication between devices, providing a means to control the orderly flow of information between linked devices.

**RAM**—An acronym for Random Access Memory for storage and retrieval of data.

**Read Cycle**—A programmed period of time or condition during which the reader will accept bar code symbol input.

**Real Time Processing**—In machine vision, the ability of a system to perform a complete analysis and take action on one part before the next one arrives for inspection.



**Region**—Area of an image. Also called a region of interest for image processing operations.

**Resolution, Image**—The number of rows and columns of pixels in an image. A “higher” resolution means that more pixels are available per element or symbol being read. For a image sensor the total number of pixels, e.g. 640 x 480.

**RS-170**—The Electronic Industries Association (EIA) standard governing monochrome television studio electrical signals. The broadcast standard of 30 complete images per second.

**Saturation**—The degree to which a color is free of white. One of the three properties of color perception along with hue and intensity (HSI).

**Scattering**—Redirection of light reflecting off a surface or through an object. See diffuse.

**Symbol Transitions**—The transition of bars and spaces on a symbol, used to detect the presence of a symbol on an object.

**Symbology**—A code type, such as Code 39 or Code 128, with special rules to define the widths and positions of bars and spaces to represent specific numeric or alphanumeric information.

**Tilt**—Symbol (or reader) rotation around the centerline of the scan beam.

**Trigger**—A signal, transition, or character string that initiates a read cycle.

**Watchdog Timer**—A security device that detects system crashes and attempts to reset the reader.



---

# Hyperlink Index

## A

About the Quadrus EZ Reader i-ix  
About the Quadrus EZ Reader User's Manual i-x  
Active Camera 3-17  
Active State (Input) 5-38  
Add Macro 11-4  
Additional Isolated Output Circuit Examples A-6  
AI (Format 05) 13-8  
Always OFF 5-19  
Always ON 5-19  
Angle of Distortion 6-12  
Angle of Distortion Threshold 5-50  
Appendices A-1  
Application Code 12-14  
Application Notes 5-33  
Applications i-12  
Approvals i-xii  
As Soon As Possible 5-6  
ASCII Table A-18  
ASCII Table with Control Characters A-18  
Assigning a Network Address 15-4  
Autodiscrimination 12-20  
Aux Port Connections 2-11  
Aux Port System Data Status 2-28  
Auxiliary Port Mode 2-12  
Axial Non-uniformity 6-6  
Axial Non-Uniformity Threshold 5-47

## B

Background Color 4-31, 10-9, 10-12  
Bad Symbol 5-43  
Bad Symbol Message 5-10  
Bad/No Symbol Output 5-12, 5-14, 5-16  
Bad/No Symbol Qualification 5-10  
Bar Code Configuration 5-36, 12-16  
Bar Width Status (Pharmacode) 4-21  
Baud Rate, Aux Port 2-11  
Baud Rate, Host Port 2-4  
BC412 4-12  
Beeper 5-21

---

Binary 5-29  
Binary Frames 15-10  
Bitmap 5-29  
Boot Code 12-14  
Both 4-19

## **C**

Calculating Number of Captures in a Rapid Capture Application 3-20  
Calculator 9-13  
Calibrate 5-36, 9-3  
Calibrate by ESP 1-10  
Calibrate by EZ Button 1-10  
Calibrate by Serial Command 1-10, 9-3  
Calibrate Settings 1-10  
Calibration 12-20  
Camera Setup 9-1  
Camera Setup by ESP 9-2  
Camera Setup Serial Commands 9-2  
Capture 11-5  
Capture and Decode 9-4  
Capture Mode 3-18  
Capture Time 6-8  
Capture Timing 3-23  
CCD Database Index 10-8  
CCD Focal Distance, FOV, DOF and Symbol Size by Lens Type A-24  
CCD Image Sensor 9-14  
CCD Image Sensor Database 10-8  
Cell Fill 5-50, 6-11  
Change Background Color 11-5  
Change Echo Font 11-5  
Change Font 11-5  
Check Digit Output (BC412) 4-12  
Check Digit Output Status (Code 39) 4-8  
Check Digit Output Status (Interleaved 2 of 5) 4-14  
Check Digit Status (Code 39) 4-8  
Check Digit Status (Interleaved 2 of 5) 4-14  
Check Required Hardware 1-2  
Cleaning A-29  
Clear 11-5  
CMOS Database Index 10-10  
CMOS Focal Distance, FOV, DOF and Symbol Size by Lens Type A-25  
CMOS Image Sensor 9-15, 10-10  
Code 128 4-11  
Code 39 4-8

---

Codeword Collection (PDF417) 4-26  
Command Processing Mode 2-17  
Communicating in Ethernet 15-7  
Communication Protocol Commands A-19  
Communications 2-1  
Communications by ESP 2-2  
Communications Port (Image Output) 5-29  
Communications Serial Commands 2-3  
Communications Standards A-3  
Compliance Indicator 13-3  
Composite 4-28  
Concatenating Configuration Commands A-16  
Configuration Command Status 12-19  
Connect Message 8-5  
Connect Status 8-4  
Connect the System 1-3  
Connecting by RS-232 1-2, 1-3  
Connecting by TCP/IP 1-2, 1-3  
Connecting for EZ Button Setup without a Host 1-3  
Connectivity Accessories A-8  
Construct 1 13-2  
Construct 2 13-2  
Continuous Capture 3-22  
Continuous Capture Mode 10-5  
Continuous Capture Mode Examples 3-27  
Continuous Read 3-7  
Continuous Read 1 Output 3-8  
Contrast 10-11  
Contrast (CMOS) 9-16  
Control Characters A-17  
Control/Hex Output 5-24  
Copy 11-5  
Counters 12-4  
Counters by ESP 12-4  
Counters by Serial Command 12-4  
Counts (Read Only) 8-3  
Custom Default Saves 8-3  
Customer Default Parameters 12-18

## **D**

Daisy Chain Autoconfigure 2-19  
Daisy Chain ID 2-18  
Daisy Chain ID Status 2-18  
Daisy Chain Mode 2-16

---

Daisy Chain Reader ID 2-20  
Daisy Chain Reader Number 2-20  
Daisy Chain Remote Secondary Reader ID 2-20  
Data 14-12  
Data Bits, Aux Port 2-12  
Data Bits, Host Port 2-5  
Data Element Separator 13-3  
Data initiated from the Auxiliary Port 2-14, 2-15  
Data initiated from the Host 2-13, 2-15  
Data initiated from the Reader 2-13, 2-14, 2-15  
Data is initiated from the Host 2-14  
Data Matrix 4-4, 6-5  
Data Matrix Symbol Comparison A-20  
Data Matrix Symbology A-20  
Data Qualifier 13-3  
Database Index 14-12  
Decode Time 6-8  
Default Macros 11-4  
Default on Power-On 12-18  
Default on Power-On (EZ Button) 5-34  
Default Settings 11-5  
Defaulting/Saving/Resetting 12-17  
Defaults 12-17  
Define a Carriage Return as a Character A-17  
Define a Space as a Character A-17  
Delete Master Symbol Data 12-11  
Detailed Noread Message 5-7  
Determine Depth of Field A-21  
Device Control 12-6  
Device Control by ESP 12-6  
Device Control By Serial Command 12-6  
DI (Format 06) 13-8  
Diagnostic Warning 5-40  
Diagnostic Warning to Output 3 5-55  
Diagnostic Warnings to Output 2 5-53  
Diagnostics 5-51, 8-1  
Diagnostics by ESP 8-2  
Diagnostics by Serial Command 8-2  
Differences from other Protocols 15-8  
Dimension 1 (2D Symbology Qualification) 5-14  
Dimension 2 (2D Symbology Qualification) 5-15  
Dimension Mode (2D Symbology Qualification) 5-14  
Dimension Tolerance (2D Symbology Qualification) 5-15  
Direction (Pharmacode) 4-21  
Disable Reader 12-6

---

Disabled 4-18, 5-4, 5-7, 5-12, 5-14, 5-16, 5-20, 5-25, 5-28, 5-30, 5-32, 5-34, 5-36, 5-38  
Disclaimer i-ii  
Disconnect Message 8-4  
Disconnect Status 8-4  
Discrete Outputs 6-3  
Dot Center Offset 5-49, 6-10  
Dot Ovality 6-12  
Dot Ovality Threshold 5-50  
Dot Shape 6-10  
Downloading ESP from the Web 1-5  
DPM Grade (LED Configuration) 5-22  
DSP Code 12-14  
Dual Camera Switching 3-25  
Dynamic Setup 9-12

## ***E***

EAN Status 4-17  
ECC 000 4-4  
ECC 050 4-5  
ECC 080 4-5  
ECC 100 4-5  
ECC 120 4-6  
ECC 130 4-6  
ECC 140 4-5  
ECC 200 4-4  
ECC Level 6-9  
Editing a Macro 11-4  
EID Number Too Long 13-7  
Electrical Specifications A-4  
Embedded Menus A-30  
Emissions/Immunity A-2  
Enable Autothreshold 9-6  
Enable Both 5-12, 5-14, 5-16  
Enable Live Video 1-14  
Enable PDF Information 12-3  
Enable Reader 12-6  
Enabled 4-18, 4-28, 5-7, 5-34  
Enabled (synchronous trigger) 5-32  
Encoding a UUI 13-2  
End of Read Cycle 3-15, 5-6  
End of Read Cycle Mode 3-15  
End Read Rate Test 12-3  
Enter Decodes/Second Test 12-3  
Enter Master Symbol Data 12-9

---

Enter Percent Test 12-3  
Entering Special Characters in Embedded Menus A-17  
Entering Special Characters in Serial Commands A-17  
Enterprise Identifier (EID) 13-2  
Environmental A-2  
Error Messaging 13-6  
Ethernet 2-21, 15-1, A-31  
Ethernet Application 15-8  
Evaluation 9-5  
Example of Timeout in Continuous Capture Mode 3-29  
Example of Timeout in Rapid Capture Mode 3-29  
Examples of error messages 13-6  
Exclusions i-iii  
Explanation of Modifiers for Code 39, Codabar, and Interleaved 2 of 5 4-30  
Explanation of Modifiers for Other Symbologies 4-30  
Extended Status 12-19  
External Camera Disconnect 5-51  
External Camera Message 8-4  
External Camera Timeout 3-28  
External Trigger Edge 3-10  
External Trigger Level 3-9  
External Trigger State 3-12  
Extract Range 14-6  
EZ Button 5-34  
EZ Button Modes 5-35  
EZ Button Operation 5-37  
EZ Button Setup 1-2

## **F**

F3 11-3  
Features of UII Mode 13-4  
Field of View and Lenses A-22  
File Format (Image Output) 5-29  
Filter Number 14-10  
Find 11-3  
Find Function 11-3  
Finder Pattern Status 5-12  
Firmware 12-12  
Firmware by ESP 12-12  
Firmware Update 12-12  
Firmware Verification 12-13  
Firmware Verification by ESP 12-13  
Firmware Verification by Serial Command 12-13  
FIS Options A-3



---

Five Characters Only 4-19  
Fixed Symbol Length (BC412) 4-13  
Fixed Symbol Length (Code 128) 4-11  
Fixed Symbol Length (Code 39) 4-9  
Fixed Symbol Length (Micro PDF417) 4-27  
Fixed Symbol Length (PDF417) 4-25  
Fixed Symbol Length (Pharmacode) 4-20  
Fixed Symbol Length (RSS 14 expanded) 4-22  
Fixed Symbol Length Status (BC412) 4-13  
Fixed Symbol Length Status (Code 128) 4-11  
Fixed Symbol Length Status (Code 39) 4-9  
Fixed Symbol Length Status (Micro PDF417) 4-27  
Fixed Symbol Length Status (PDF417) 4-25  
Fixed Symbol Length Status (Pharmacode) 4-20  
Fixed Symbol Length Status (RSS 14 expanded) 4-22  
Fixed Threshold Value (Pharmacode) 4-21  
Focal lens A-3  
Format Assign 14-4  
Format Assign by ESP 14-4  
Format Extract 14-5  
Format Extract by ESP 14-6  
Format Header 13-3  
Format Insert 14-7  
Format Insert by ESP 14-8  
Four Beeps (Position #4) 5-37  
FPGA Code 12-14  
From Host 2-8  
Full ASCII Set (Code 39) 4-10  
Full Duplex Mode 2-15

## **G**

Gain 10-8, 10-10  
Gain (CCD) 9-14  
Gain (CMOS) 9-15  
Gateway Address 2-22  
General Specifications A-2  
Global 6-4  
Glossary of Terms A-36  
Good Read 5-5, 5-27  
Good Read (Green Flash) 5-20  
Good Read (Image Output) 5-28  
Good read and Noread (Image Output) 5-28  
Good Read Percentage 1-11  
Good Read/Match 5-39

---

Good Read/Match Counter (or Good Read Counter) 12-5  
Good Read/Match Counter Reset 12-5  
Grade 6-5  
Grading Symbol Quality 6-8  
Green Flash Duration 5-21  
Green Flash Mode 5-20  
Guard Bar (Interleaved 2 of 5) 4-16

## **H**

Half Duplex Mode 2-14  
Hardware Configuration 1-2  
Hardware Default 12-18  
Height (Row Depth) 9-11  
Hex String 14-7  
Highlighting i-x  
Histogram 9-6  
Histogram Evaluation 9-6  
Hollow Mode 9-21  
Host 422 Status 2-10  
Host Communications i-ix  
Host Port Connections 2-4  
Host Port Protocol 2-6

## **I**

I/O Parameters 5-1  
I/O Parameters by ESP 5-2  
I/O Parameters Serial Commands 5-3  
IB-151 Ethernet/USB Interface A-9  
IB-152 Terminal Strip Interface Kit A-10  
Illumination Source 9-17  
Image Captioning 5-30  
Image File Transfers 15-10  
Image Frame 5-27  
Image Library Request 12-20  
Image Output 5-28  
Image Processing Settings 9-19  
Image Processing Timeout 9-20  
Image Storage Mode 3-30  
Image Storage Type 3-30  
In Read Cycle 5-40  
Indicators A-3  
Inkjet/Direct Symbol Quality 6-10  
Input 1 5-38

---

Input Examples A-7  
Install ESP 1-5  
Installing ESP from a CD 1-5  
Interface Standards A-31  
Interleaved 2 of 5 4-14  
Internal Camera Timeout 3-28  
Invalid AI 13-6  
Invalid Characters 13-7  
Invalid Compliance Indicator 13-7  
Invalid DI 13-6  
Invalid Format Header 13-6  
Invalid TEI 13-6  
IP Address 2-21  
IP Address Mode 2-22  
IP Database 10-1  
IP Database by ESP 10-2  
IP Database Serial Commands 10-3  
IP Database Window 10-6  
ISO/IEC 16022 Grade (LED Configuration) 5-22  
ISO/IEC 16022 Symbol Quality 6-5

## **J**

JPEG 5-29  
JPEG Quality (Image Output) 5-29

## **L**

Large Intercharacter Gap (Code 39) 4-9  
Last Capture 5-27  
Last Frame 3-16  
Last Frame or New Trigger 3-16  
Latch Mode 1 5-41  
Latch Mode 2 5-41  
Latch Mode 3 5-41  
LED Aperture Window i-xi  
LED Configuration Mode 5-22  
Left (Column Pointer) 9-10  
Length 14-5, 14-6, 14-7, 14-11  
Light Collection A-2  
Light Source A-2  
Limitations 15-10  
Line Scan 9-7  
Linear Symbologies 5-8  
Live (Video Output) 5-26

---

Live Video 5-36  
Load Current Settings from Database 10-13  
Load IP Database (EZ Button) 5-35  
Load New Master 5-36  
Locate 9-3  
Locate by ESP 1-9  
Locate by EZ Button 1-8  
Locate the Symbol in the FOV 1-8  
Locate Time 6-8  
Longitudinal Redundancy Check 2-27  
Lower Case Characters 13-6  
LRC Status 2-27

## **M**

Macro Name 11-4  
Macro Value 11-4  
Macros 11-4  
Make Menu Changes and Save in ESP 1-13  
Marking Method 6-10  
Master Database 12-7  
Master Database Overview 12-7  
Master Symbol Database Size 12-8  
Match 5-4  
Match (Green Flash) 5-20  
Match Length 7-7  
Match Replace 7-12  
Match Start Position 7-6  
Matchcode 7-1  
Matchcode by ESP 7-2  
Matchcode Serial Commands 7-2  
Matchcode Type 7-4  
Matrix Size 6-9  
Maximum Characters for Master Symbol 12-8  
Maximum Element Sizes by Lens Type A-23  
Mechanical A-2  
Message Trailer 13-3  
Micro PDF417 4-27  
Microscan Default Parameters 12-18  
Microscan Protocol/Host RS-232 Supported 15-8  
Minimum Number of Bars 5-10  
Minimum Number of Bars (Pharmacode) 4-20  
Minimum Number of Qualified Scan Lines 5-11  
Mirrored Image 9-22  
Mismatch 5-4, 5-39, 5-43

---

Mismatch (Green Flash) 5-20  
Mismatch Counter 12-5  
Mismatch Counter Reset 12-5  
Mismatch or Noread 5-39  
Mismatch Replace 7-13  
Mounting A-29  
Mounting Specifications A-3  
Multidrop 2-9, A-32  
Multidrop Addresses A-35  
Multidrop Communications A-32  
Multiple Captures A-27  
Multiple Symbols in Fast Linear Mode 9-19  
Multisymbol 3-5  
Multisymbol Separator 3-6

## **N**

Narrow Margin Status 10-9  
Narrow Margins 4-29, 10-12  
Network 2-21  
Network Protocols Supported 15-8  
New Master Pin 7-14  
New Trigger 3-16  
Next Row 11-4  
No Symbol 5-43  
No Symbol Message 5-10  
Non-UII Characters in a UII Message Stream 13-3  
Noread 5-27, 5-39, 5-43  
Noread (Image Output) 5-28  
Noread Counter 12-4  
Noread Counter Reset 12-4  
Noread Message 5-7, 5-9  
Noread Message Mode 5-7  
Notes on Triggered Capture Mode 3-21  
Number of Active Database Settings 10-7  
Number of Captures 3-18  
Number of External Camera Captures 3-26  
Number of Internal Camera Captures 3-25  
Number of Symbols 3-5  
Number of Triggers (Trend Analysis) 5-44  
Number to Output On (Trend Analysis) 5-44

---

## O

- Object Detector A-28
- Object Qualification 5-12, 5-14, 5-16
- Offset 10-11
- Offset (CMOS) 9-16
- On When in the Read Cycle 5-19
- On When NOT In The Read Cycle 5-19
- One-Dimensional/Stacked Symbology Qualification 5-10
- Operation of IP Database 10-4
- Operational Tips A-29
- Optoisolator Inputs A-7
- Optoisolator Outputs A-5
- Ordered Output Filter 14-13
- Orientation Mode (2D Symbology Qualification) 5-16
- Orientation Value 5-17
- Other Camera-related Parameters 9-23
- Other Operational Serial Commands 12-20
- Output #1 Pulse 12-6
- Output #2 Pulse 12-6
- Output #3 Pulse 12-6
- Output 1 Parameters 5-39
- Output 2 Parameters 5-52
- Output 3 Parameters 5-54
- Output Circuit Examples A-5
- Output Filter Configuration 14-9
- Output Filter Configuration Rule # 1 14-9
- Output Filter Configuration Rule # 2 14-9
- Output Filter Configuration Rule # 3 14-9
- Output Format 14-1
- Output Format Serial Commands 14-2
- Output Format Status 14-3
- Output Format Status by ESP 14-3
- Output Format Status Disabled 14-3
- Output Format Status Enabled 14-3
- Output Index 14-5, 14-7
- Output Indicators 5-19
- Output Mode 6-5
- Output Mode (Output 1) 5-41
- Output On (Output 1) 5-39
- Output on Angle of Distortion 5-49
- Output on Axial Non-Uniformity 5-46
- Output on Cell Fill 5-48
- Output on Dot Center Offset 5-48
- Output on Dot Ovality 5-49

---

Output on Print Growth 5-45  
Output on Symbol Contrast 5-45  
Output on Unused ECC 5-46  
Output State (Output 1) 5-41  
Over Temperature 5-51  
Over Temperature Message 8-6  
Over Temperature Status 8-6  
Overview of IP Database 10-4  
Overview of Matchcode 7-3  
Overview of Symbol Quality 6-3

## **P**

Parity, Aux Port 2-11  
Parity, Host Port 2-4  
Parse Table 14-6  
Part Number Too Long 13-7  
Paste 11-5  
Pause 11-5  
PDF417 4-25  
Percent Cell Damage 6-8  
Perform Readability Test 1-11  
Pharmacode 4-20  
Pixels and Resolution A-22  
Pixels per Element 6-9  
Placeholder 14-11  
Point-to-Point (standard) 2-6  
Point-to-Point with RTS/CTS 2-7  
Point-to-Point with RTS/CTS & XON/XOFF 2-7  
Point-to-Point with XON/XOFF 2-6  
Polling Mode D 2-7  
Polling Reset A-33  
Polling Sequence A-32  
Position Reader and Symbol 1-4  
Postamble 2-25  
Postamble Character(s) 2-25  
Postamble Status 2-25  
Power Requirements A-3  
Power-on 8-3  
Power-on Saves 8-3  
Preamble 2-24  
Preamble Character(s) 2-24  
Preamble Status 2-24  
Preliminary Steps 15-3  
Primary (Command) TCP Port 15-9

---

Primary TCP Port 2-22  
Print Growth 6-6  
Print Growth Threshold 5-47  
Processing Mode 9-19, 10-9, 10-11  
Pulse 5-41  
Pulse Width (Output 1) 5-41

## **Q**

QR Code 4-7  
Quadrus EZ Maximum 2D Symbol Sizes A-23  
Quadrus EZ Reader i-i  
Quick Start 1-1  
Quiet Zone 6-9

## **R**

Rapid Capture Mode 3-18, 10-5, A-26  
Rapid Capture Mode Examples 3-26  
Rapid Capture Mode, Single Camera 3-19  
Read Cycle 3-1, 5-6  
Read Cycle by ESP 3-2  
Read Cycle Results (Image Captioning) 5-30  
Read Cycle Serial Commands 3-3  
Read Cycle Setup 3-4  
Read Cycle Timeout 3-16  
Read Duration Output 5-18  
Read Duration Output Mode 5-18  
Read Duration Output Separator 5-18  
Read Next Symbol as Master Symbol 12-10  
Read Parameters A-3  
Read Rate 5-36, 12-3  
Read Rate by ESP 12-3  
Read Rate by Serial Command 12-3  
Reader Dimensions A-2  
Reader Position 1-4  
Reader Status Byte 12-19  
Reader Status Requests 12-19  
Region of Interest (ROI) 9-8  
Region of Interest by Click and Drag 9-9  
Region of Interest by Serial Commands 9-10  
Relative Sizes of FOVs by Lens Type A-23  
Replacement String 7-12, 7-13  
Reports 6-3  
Request All Database Settings 10-14



---

Request All Master Symbol Data 12-10  
Request Checksum 12-14  
Request Checksum by ESP 12-14  
Request Checksum by Serial Command 12-14  
Request Database Settings 10-14  
Request Master Symbol Data 12-10  
Request New Master Status 12-11  
Request Part Number 12-13  
Request Sensor Type 12-15  
Request Sensor Type by ESP 12-15  
Request Sensor Type by Serial Command 12-15  
Required 4-18, 4-28  
Reset Counts 5-38  
Resets 8-3, 12-17  
Resolution 8-7  
Response Timeout 2-26  
Restrictions 5-32  
RS-232 A-31  
RS-232 Auxiliary Port 2-11  
RS-232/422 Host Port 2-4  
RS-422 A-31  
RS-485 A-31  
RSS Expanded 4-22  
RSS Limited 4-23  
RSS-14 4-24  
Rules for Output Filter Configuration 14-9  
Rules for Utility and Configuration Commands A-16

## S

Safety Certifications A-3  
Save 11-5  
Save Current Settings to Database 10-13  
Save Current Text 11-5  
Save for Power On 5-36  
Save for Power-On (EZ Button) 5-35  
Saved for Power-on 12-17  
Select All 11-5  
Select Communications Protocol 1-7  
Select Model 1-6  
Select NUL as the Character A-17  
Select Reset A-34  
Select Sequence A-34  
Selected Capture 5-27  
Sensor Type 12-15

---

Sensor type A-3  
Separator Character (Composite) 4-28  
Separator Character (UPC/EAN) 4-19  
Separator Status (Composite) 4-28  
Separator Status (UPC/EAN) 4-18  
Sequence On Mismatch 7-10  
Sequence On Noread 7-9  
Sequence Step 7-11  
Sequential Matching 7-5  
Serial Command Beep Status 5-23  
Serial Command Echo Status 5-23  
Serial Command Format A-16  
Serial Command Status Request A-17  
Serial Configuration “K” Commands A-16  
Serial Configuration Command Conventions A-16  
Serial Configuration Commands A-11  
Serial Data 3-11  
Serial Data or External Edge 3-11  
Serial Number Too Long 13-7  
Serial Trigger 3-13  
Serial Trigger Character (delimited) 3-13  
Serial Utility Commands A-16  
Serial Verification 5-23  
Service Message 8-7  
Service Message Status 8-7  
Service Unit 5-51  
Setup 15-2  
Shift-F3 11-3  
Shutter Speed 10-8, 10-10  
Shutter Speed (CCD) 9-14  
Shutter Speed (CMOS) 9-15  
Side View of IB-150 1-3  
Single Beep (Position #1) 5-37  
Single Capture A-26  
Slide Show 5-27  
Software Defaults 12-18  
Space in Data Qualifier 13-6  
Standard (LED Configuration) 5-22  
Start and Stop Trigger Characters (non-delimited) 3-13  
Start Character (non-delimited) 3-14  
Start Location 14-5, 14-6  
Start/Stop Status 5-11  
Statement of Agency Compliance 1-xii  
Static Inkjet/Direct Symbol Quality Output 6-13  
Static ISO/IEC 16022/Grading Symbol Quality Output 6-13

---

Static Presentation (Green Flash) 5-20  
Static Symbol Quality Outputs 6-13  
Statistic Mode 1 (counts) (Image Captioning) 5-31  
Statistic Mode 2 (timing) (Image Captioning) 5-31  
Status 14-4  
Steps for Entering and Using Master Symbols 7-3  
Stop 11-5  
Stop Bits, Aux Port 2-12  
Stop Bits, Host Port 2-4  
Stop Character (non-delimited) 3-14  
Store Noread Image 3-30  
Subnet 2-21  
Supplementals Status (UPC/EAN) 4-18  
Supplementals Type (UPC/EAN) 4-19  
Switching by Number of Captures 3-25  
Switching by Timeout 3-28  
Switching Mode 3-25  
Symbol Contrast 6-5  
Symbol Contrast Threshold 5-46  
Symbol Data Output 5-4  
Symbol Length #1 (Interleaved 2 of 5) 4-15  
Symbol Length #2 (Interleaved 2 of 5) 4-15  
Symbol Number 14-4  
Symbol Parse 14-6  
Symbol Quality 5-40, 6-1  
Symbol Quality by ESP 6-2  
Symbol Quality Separator 6-4  
Symbol Quality Serial Commands 6-2  
Symbol Quality to Output 1 (Inkjet/Direct) 5-48  
Symbol Quality to Output 1 (ISO/IEC 16022) 5-45  
Symbol Quality to Output 2 (Inkjet/Direct) 5-53  
Symbol Quality to Output 2 (ISO/IEC 16022) 5-52  
Symbol Quality to Output 3 (Inkjet/Direct) 5-55  
Symbol Quality to Output 3 (ISO/IEC 16022) 5-54  
Symbol Size 1 (2D Symbology Qualification) 5-13  
Symbol Size 2 (2D Symbology Qualification) 5-13  
Symbol Size Mode (2D Symbology Qualification) 5-12  
Symbol Size Tolerance (2D Symbology Qualification) 5-13  
Symbologies 4-1  
Symbologies by ESP 4-2  
Symbologies Serial Commands 4-3  
Symbology ID 4-30  
Symbology Type 14-10  
Symbology Types A-3  
Synchronous Trigger 5-32

---

## **T**

Table of Contents i-iv  
Target system 5-36  
TEI (Format DD) 13-8  
Terminal Dropdown Menu 11-5  
Terminal Mode 11-1  
Terminal Window 11-2  
Terminal Window Functions 11-5  
Test (Video Capture) 9-4  
Testing by ESP 1-11  
Testing by EZ Button 1-11  
TFTP Server 15-10  
Three Beeps (Position #3) 5-37  
Threshold 8-7  
Threshold (Histogram) 9-6  
Threshold Mode 9-18, 10-8, 10-11  
Threshold Value 9-18, 10-9, 10-11  
Thresholding 9-18  
Time Before 1st Capture 3-23  
Time Before First Capture 3-23  
Time Between Captures 3-24  
Time Delay Between Captures 3-24  
Timed Capture 3-19  
Timeout 3-15  
Timeout or New Trigger 3-16  
Top (Row Pointer) 9-10  
Total Read Time 6-4  
Trailer Character 13-3  
Transparent Mode 2-13  
Trend Analysis 5-40  
Trend Analysis (Output 1) 5-42  
Trend Analysis Mode 5-43  
Trend Analysis to Output 2 5-52  
Trend Analysis to Output 3 5-54  
Trigger 3-7  
Trigger Counter 12-4  
Trigger Counter Reset 12-4  
Trigger Edge 3-10  
Trigger Filter Duration 3-12  
Trigger Image Mode 5-27  
Trigger Level 3-9  
Trigger Mode 3-7  
Trigger Mode (EZ Button) 5-34  
Triggered 5-25

---

Triggered Capture 3-21  
Triggered Captures, Typical 3-21  
Two Beeps (Position #2) 5-37  
Two Characters Only 4-19  
Two-Dimensional Symbologies 5-7  
Two-Dimensional Symbology Qualification 5-12

## **U**

UII Disabled 13-5  
UII Elements 13-2  
UII Enabled with Error Messaging and Pass Through 13-4  
UII Enabled with Pass Through 13-4, 13-5  
UII Mode by ESP 13-4  
UII Mode by Serial Command 13-5  
UII Mode Error Messaging 13-5  
UII Mode Features 13-4  
UII Too Long 13-7  
UII-Only Enabled 13-4, 13-5  
UII-Only Enabled with Error Messaging 13-4  
Unique Item Identifiers 13-1  
Unlatch Output 5-38  
Unused ECC 6-7  
Unused ECC Threshold 5-47  
UPC/EAN 4-17  
User Defined Address 2-7  
User Defined Example 2-8  
User Defined Multidrop 2-9  
User Defined Point-to-Point 2-7  
Using DHCP to Configure the Reader 15-6  
Using the Reader's Default IP Address 15-5  
Utilities 12-1  
Utilities Serial Commands 12-2

## **V**

Valid Formats 13-8  
Value 6-5  
Video 9-3, A-3  
Video Input (Option) A-3  
Video Input Option 1-14  
Video Output 5-25  
Video Output (Option) A-3  
Video Output Mode 5-25  
Video Output Option 1-14

---

Video TCP Port 2-23, 15-9

## **W**

Warning and Caution Summary i-xi

Warning Message 8-6

Warranty Statement i-iii

When to Output Symbol Data 5-6

Width (Column Width) 9-11

Wild Card Character 7-8

Wildcard 14-11

Within a Serial Command 2-24, 2-25

Within an Embedded Menu 2-24, 2-25

## **X**

X-Pattern 5-19

## **Y**

Y-Modem Upload Image 12-20