

DETAILS

Product Number	C13233_HB-2X2-M
Family	HB
Type	Lens array
Color	clear
Diameter	50x50 mm
Height	8,5 mm
Style	square
Optic Material	PMMA
Holder Material	
Fastening	glue, screw, pin
Status	production ready
ROHS Compliant	Yes
Date Updated	21/04/2016



OPTICAL PROPERTIES

LED	Viewing Angle	Light Beam	Efficiency	cd/lm	Connector
XT-E	25 deg	Medium	92 %	3.700	-
XP-G	31 deg	Medium	91 %	3.100	-
XP-G2	33 deg	Medium	93 %	3.400	-
XB-D	26 deg	Medium	95 %	3.900	-
XQ-E HI	sim: 22	Medium	sim: 93 %	sim: 5.500	-
XP-G3	30 deg	Medium	94 %	2.700	-
H35C1 (LEMWA33)	29 deg	Medium	91 %	3.400	-
LUXEON Z ES	21 deg	Medium	91 %	5.640	-
LUXEON Q	26 deg	Medium	94 %	3.600	-
NVSxx19B/NVSxx19C	29 deg	Medium	91 %	3.100	-
NVSxx19B/NVSxx19C	29 deg	Medium	90 %	3.000	-
NVSxE21A	20 deg	Medium	94 %	4.970	-
Oslon Square PC	30 deg	Medium	91 %	3.400	-
Oslon Square Gen3	30 deg	Medium	93 %	3.400	-
LH351Z	32 deg	Medium	93 %	2.900	-
LH351B	31 deg	Medium	94 %	2.800	-
Z8Y15	20 deg	Medium	89 %	4.600	-
Z8Y19	22 deg	Medium	89 %	3.800	-
TL1L4	25 deg	Medium	85 %	3.500	-
RLE G1 49x223mm 4000lm xxx EXC OT	29 deg	Medium	94 %	3.000	-
RLE G1 49x245mm 4000lm xxx EXC OT	29 deg	Medium	94 %	3.000	-
RLE G1 49x121mm 2000lm xxx EXC OT	29 deg	Medium	94 %	3.000	-
RLE G1 49x133mm 2000lm xxx EXC OT	29 deg	Medium	94 %	3.000	-

D

C

B

A

4

4

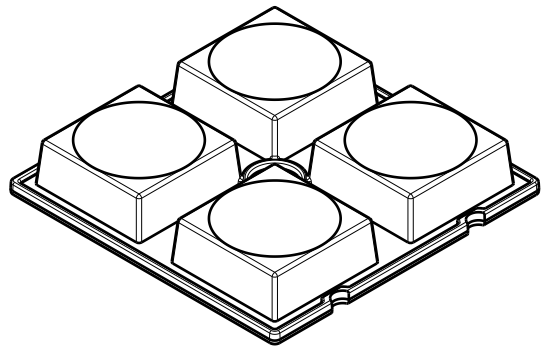
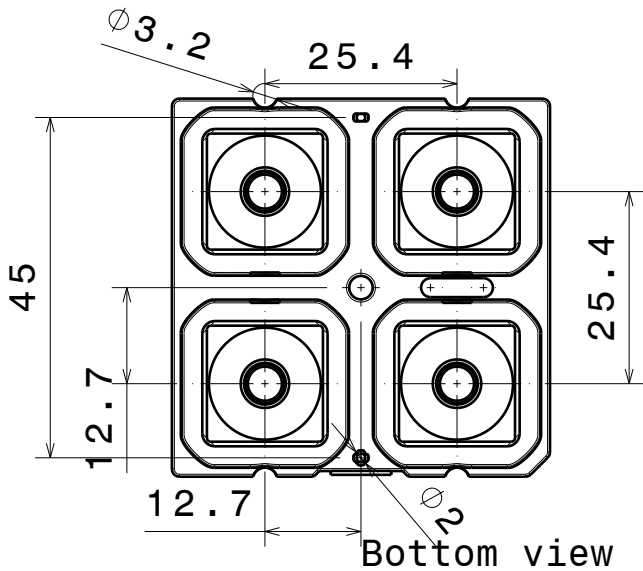

3

3

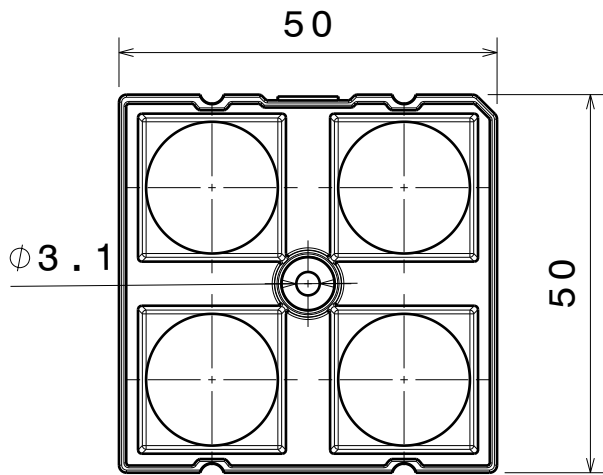
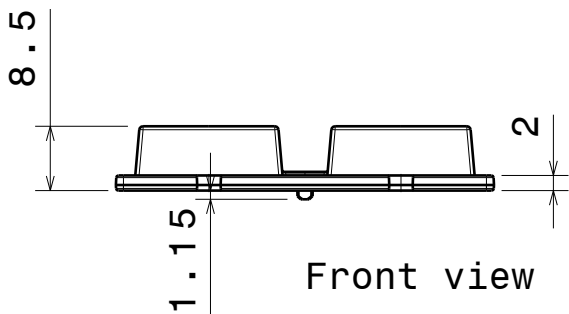

2

2

INDEX	PART NO	DESCRIPTION	MATERIAL	COLOUR
1	C13233	HB-2X2-M	PMMA	

Tolerances if not otherwise shown
 According to DIN ISO 2768-1
 Linear measures:
 Up to 30mm class M, otherwise class C.
 According to DIN ISO 2768-2
 Form and position: class L

LEDiL
 Ledil Oy
 Salorankatu 10
 FIN 24240 SALO
 Finland

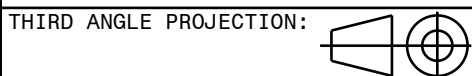

DRAWING TITLE
HB-2X2-M

This drawing is the property of LEDiL Oy. It may not be reproduced, copied or communicated without a written agreement with LEDiL Oy."

SIZE
A4
C13233

SCALE 1:1 WEIGHT SHEET 1/1

D

A

1

1

Luminaire: Ledil Oy C13233_HB-2x2-M (Cree XT-E 390lm @ 250mA) Efficiency=92%
Lamps: 1 x Cree XT-E 390lm @ 250mA

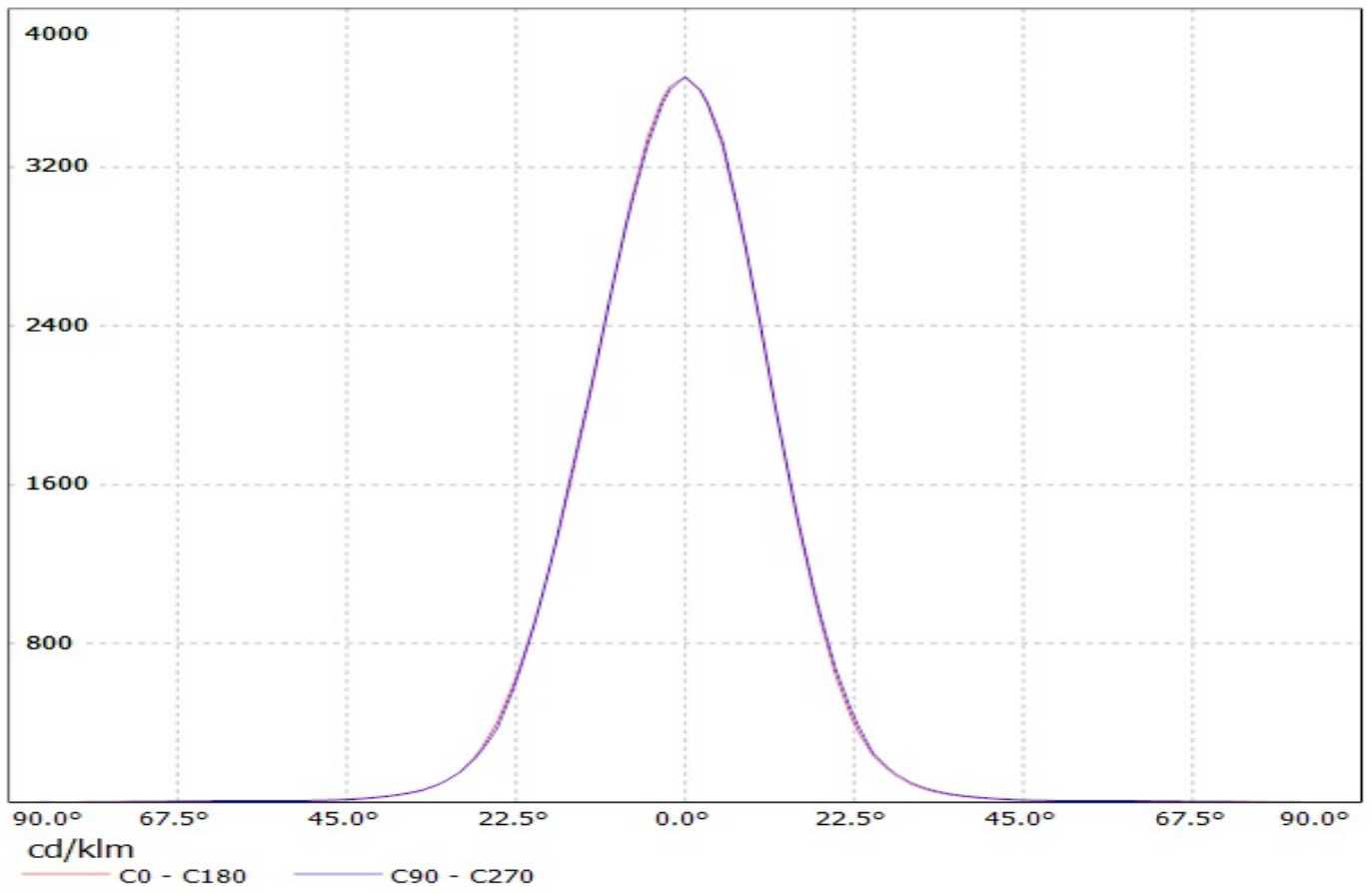

Luminaire: Ledil Oy C13233_HB-2x2-M (Cree XP-G 257lm @ 250mA) Efficiency=91%
Lamps: 1 x Cree XP-G 257lm @ 250mA

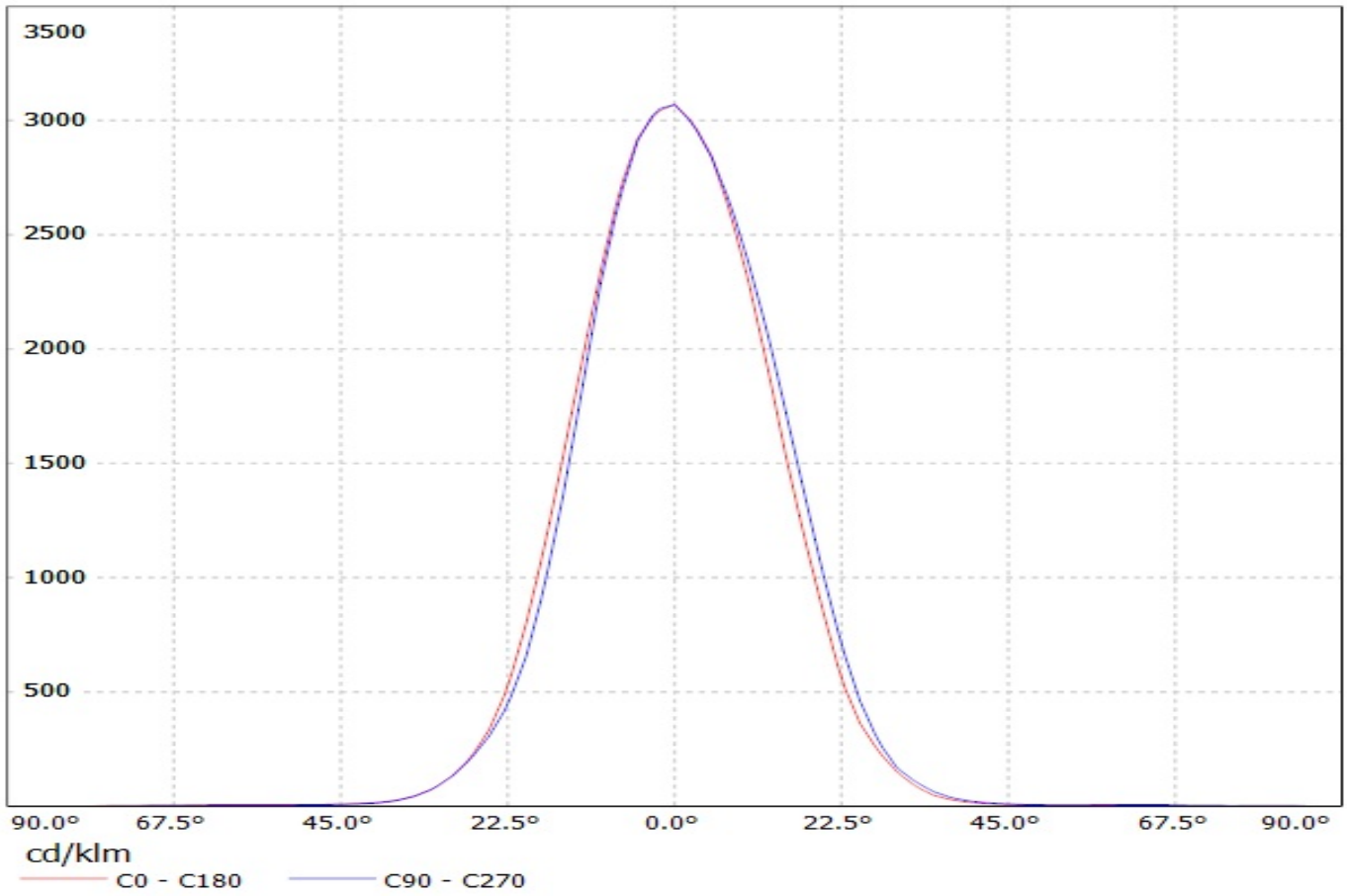

Luminaire: Ledil Oy C13233_HB-2x2-M (Cree XP-G2 420lm @ 250mA) Efficiency=93%
Lamps: 1 x Cree XP-G2 420lm @ 250mA

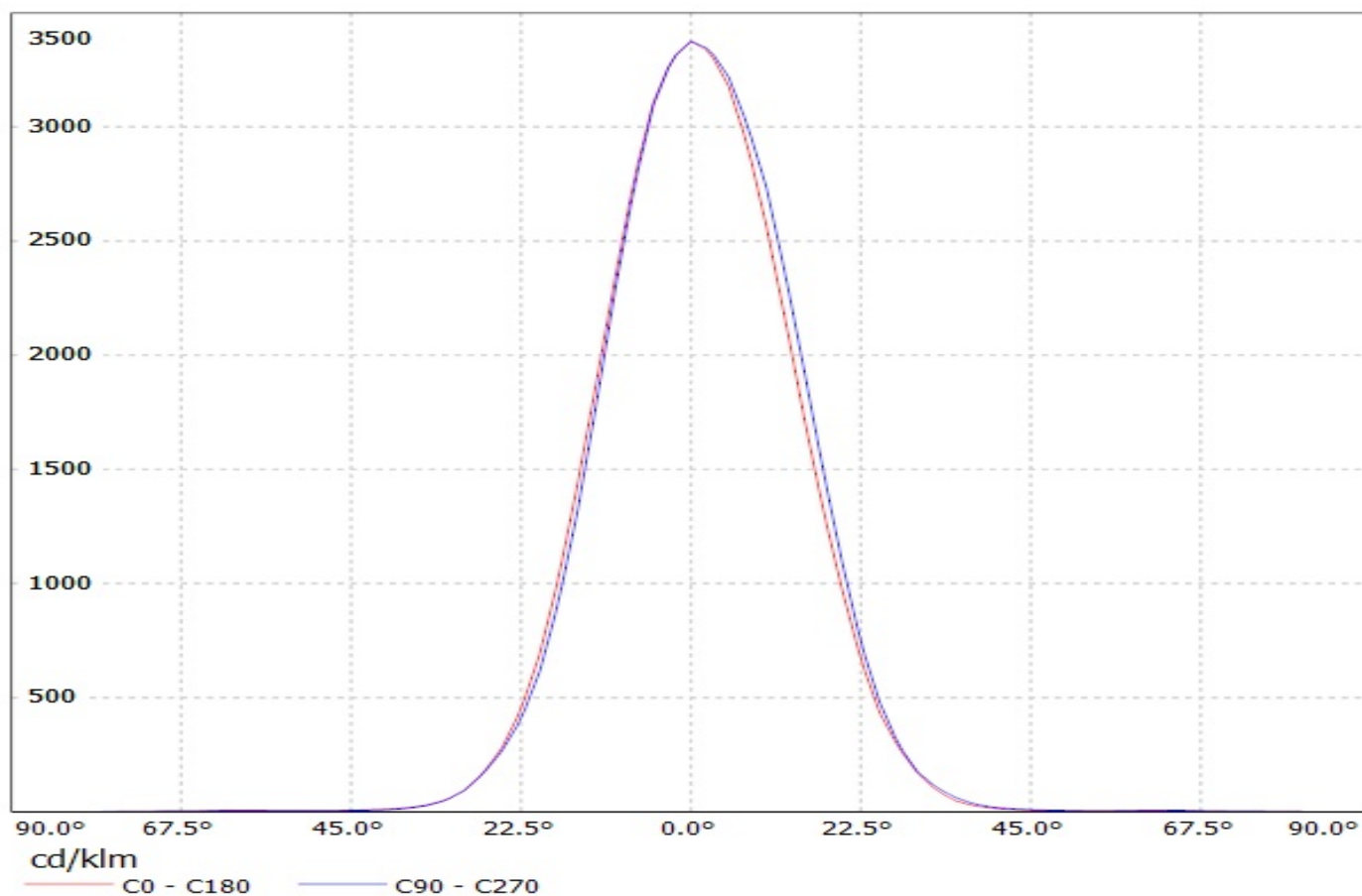

LEDiL Oy C13233_HB-2x2-M_(XB-D) Eff.95.2% / LDC (Linear)

Luminaire: LEDiL Oy C13233_HB-2x2-M_(XB-D) Eff.95.2%
Lamps: 1 x CREE_XB-D_2x2 (362.885lm@250mA)

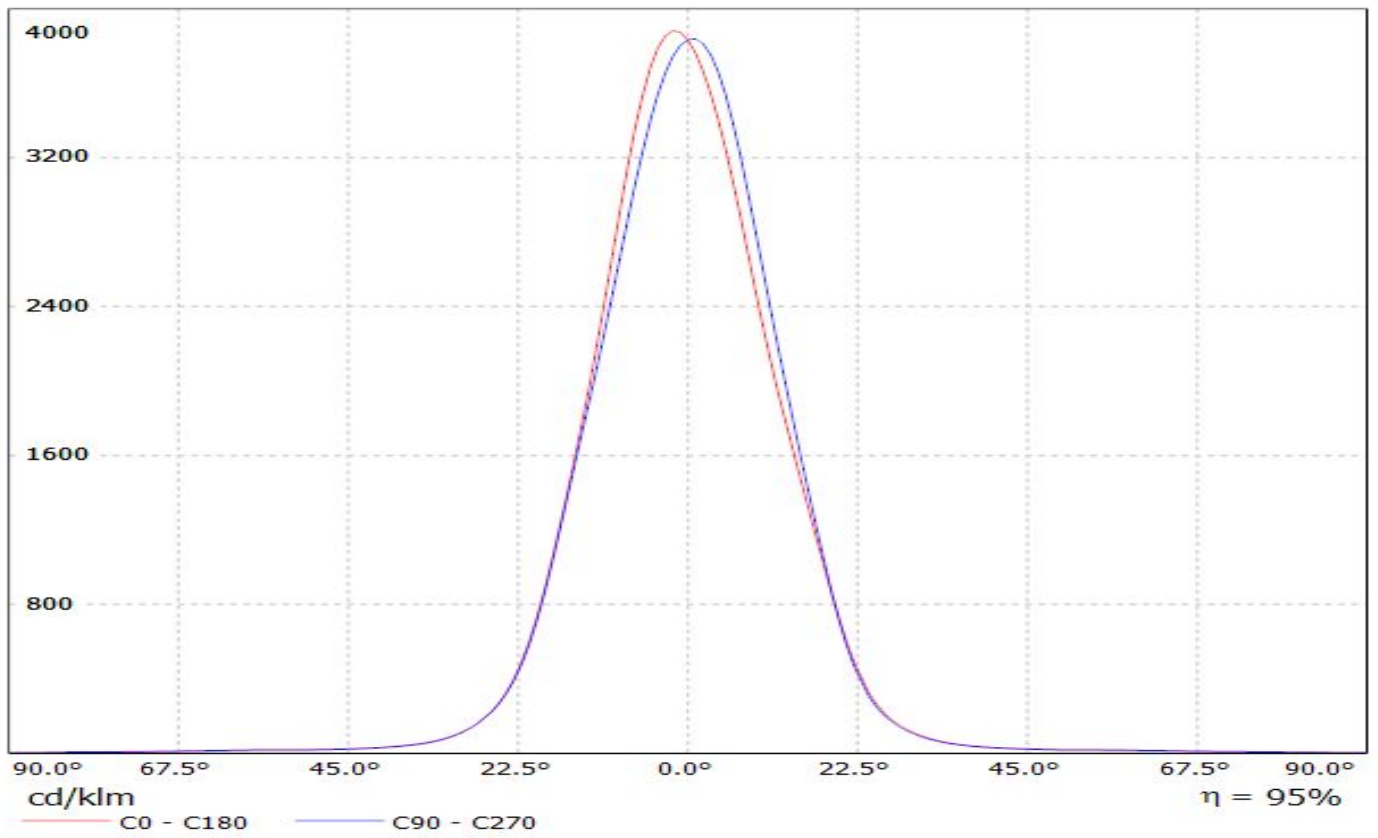

Luminaire: Ledil C13233_HB-2x2-M (XP-G3)

Lamps: 1 x Cree_XP-G3_2x2_(XPGDWT-B1-3C0-S4-0-01)_516.459lm@250mA_P=2.7885W_I=0.25A

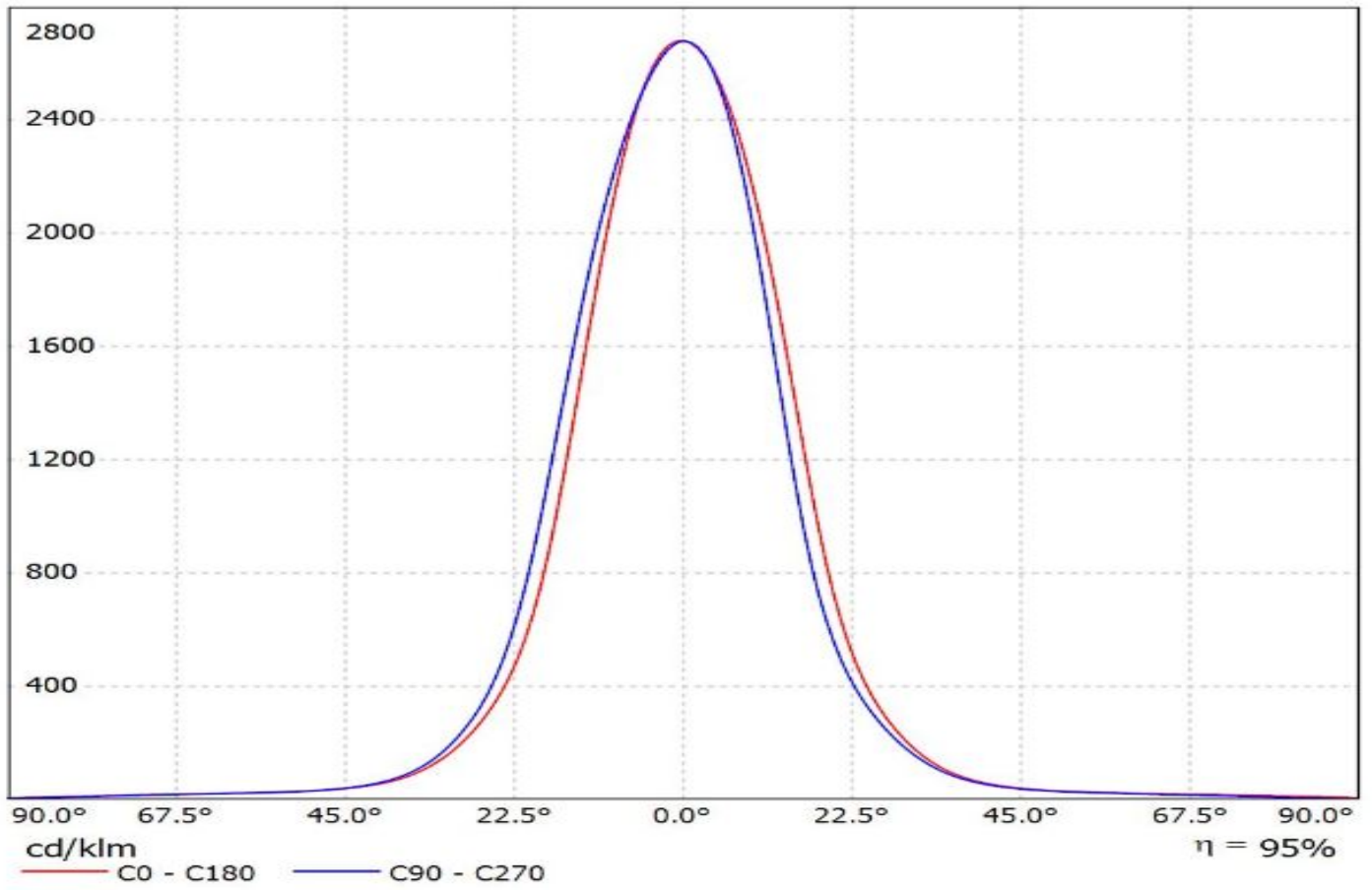

Luminaire: Ledil Oy C13233_HB-2x2-M_(3535_Ceramic_gen2) Efficiency=91%
Lamps: 1 x LG 3535 Ceramic gen2 (PKG5700K) 461lm @ 250mA CCT=6600K P=2.9W I=250mA

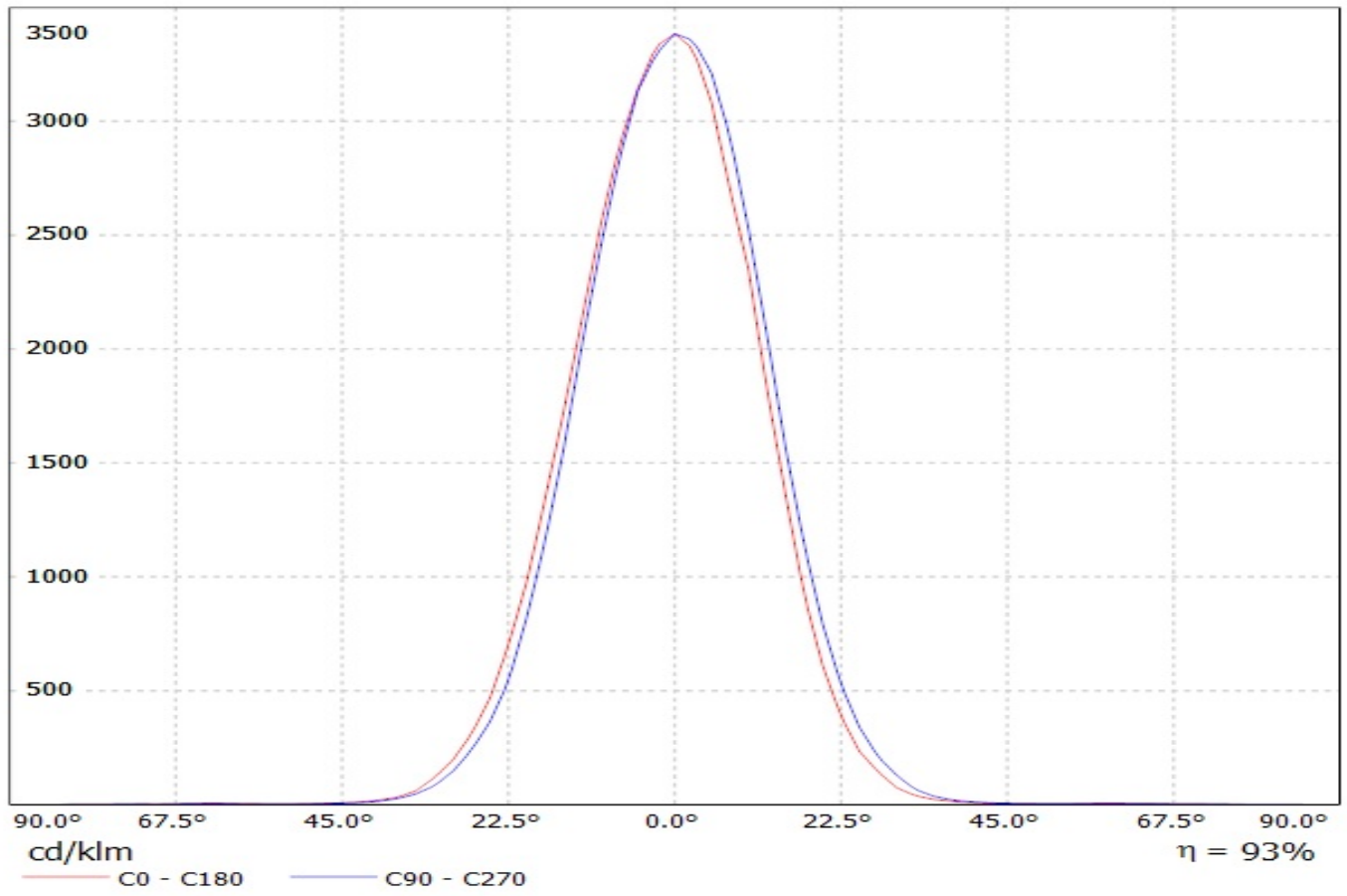

Luminaire: Ledil Oy C13233_HB-2X2-M_(Luxeon_Z_ES) Efficiency=91%
Lamps: 1 x Luxeon Z ES (LXZ2-3090) 209lm @ 250mA CCT=3000K P=2.8W I=250mA

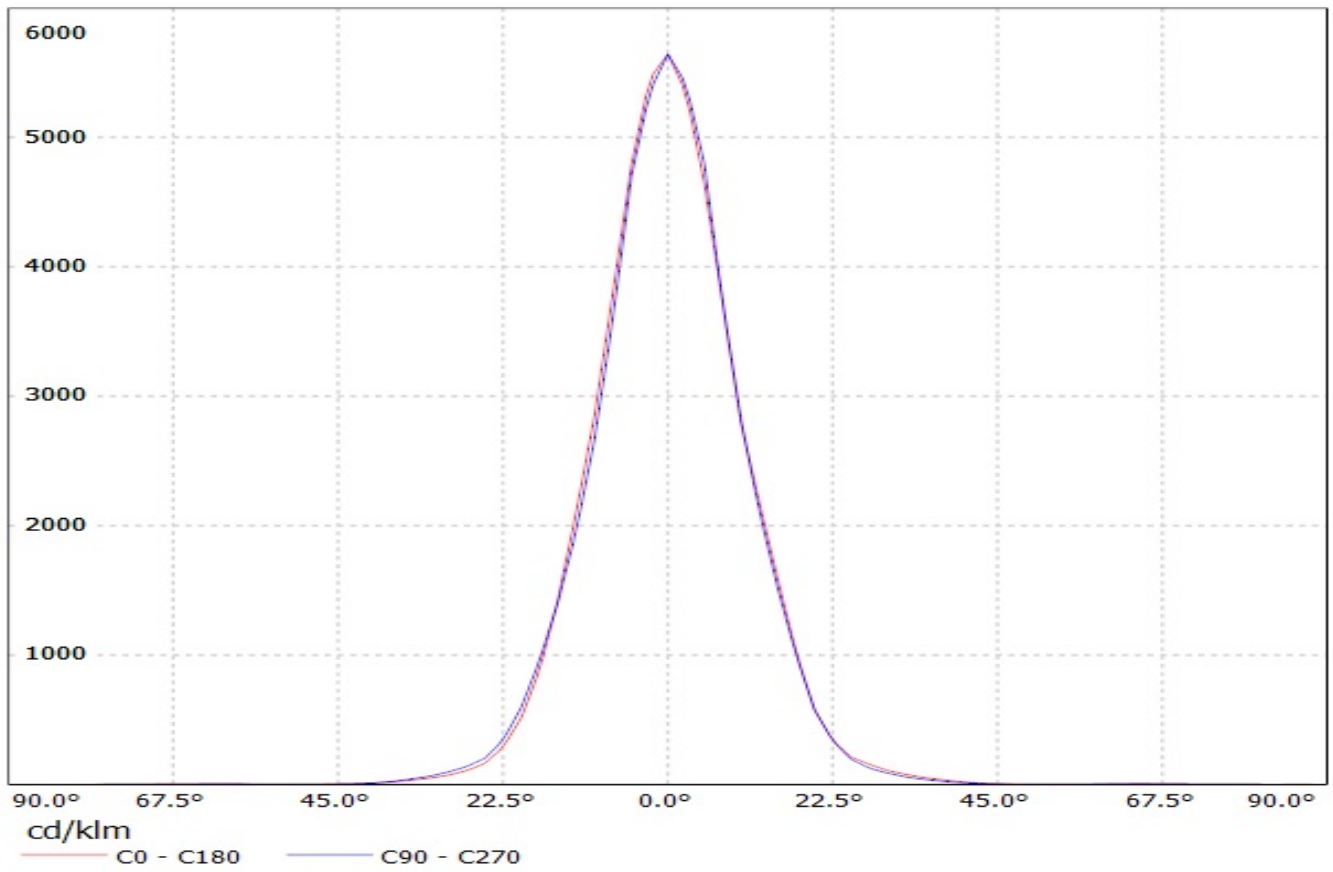

Luminaire: LEDiL Oy C13233_HB-2X2-M_(LUXEON_Q) Eff.94.5%
Lamps: 1 x LUXEON_Q_2x2_(LHQ-3080)_298.363lm@250mA_P=2.87385W_I=249.9mA

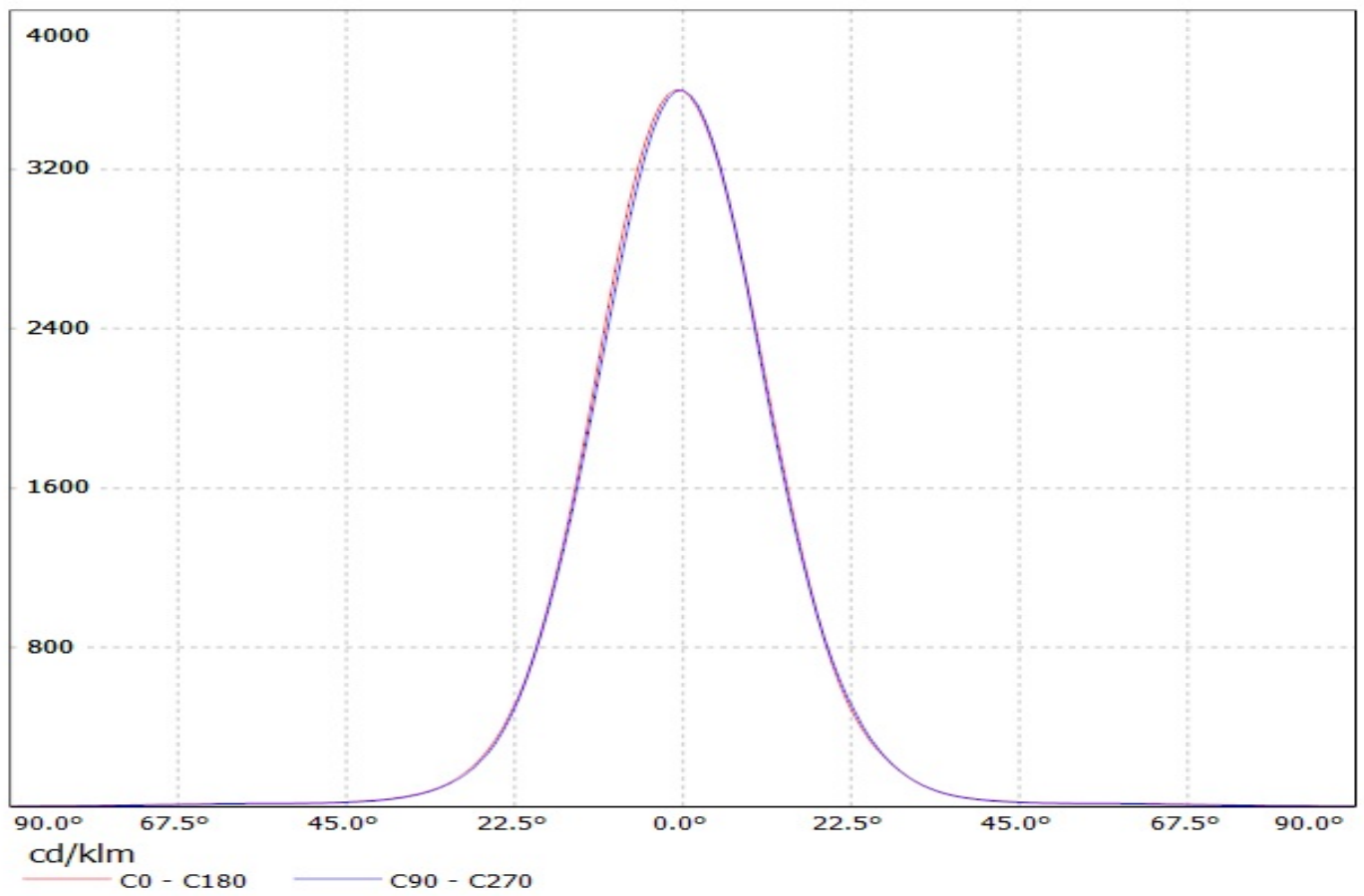

Luminaire: Ledil Oy C13233_HB-2x2-M (Nichia 219B 306lm @ 250mA) Efficiency=91%
Lamps: 1 x Nichia 219B 306lm @ 250mA

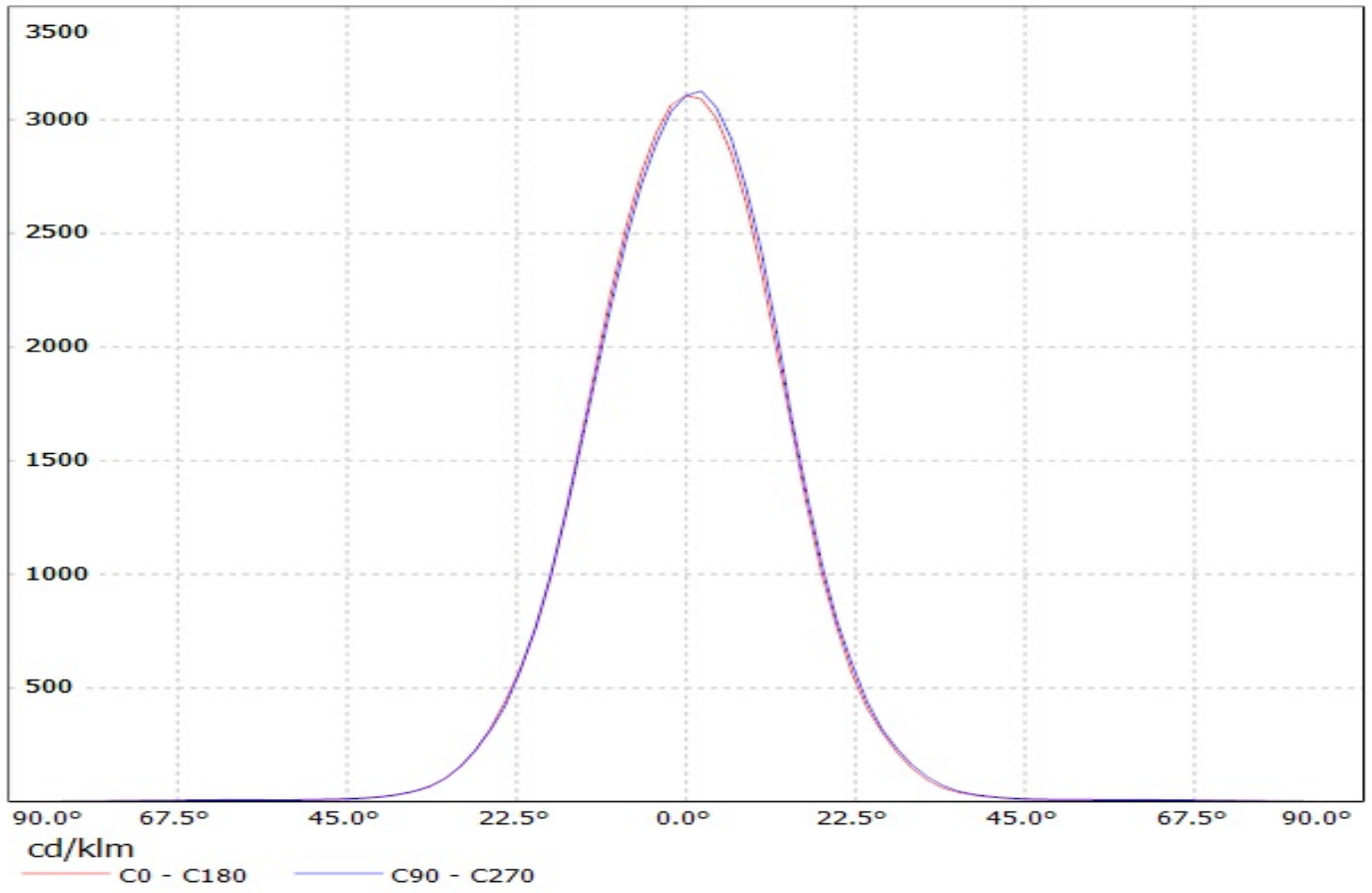

Luminaire: Ledil C13233-HB_2x2-M_(NVSL219CE)

Lamps: 1 x Nichia_NVSL219CE_496.405lm@250mA_CCT=4000K_P=2.8465W_I=0.25A

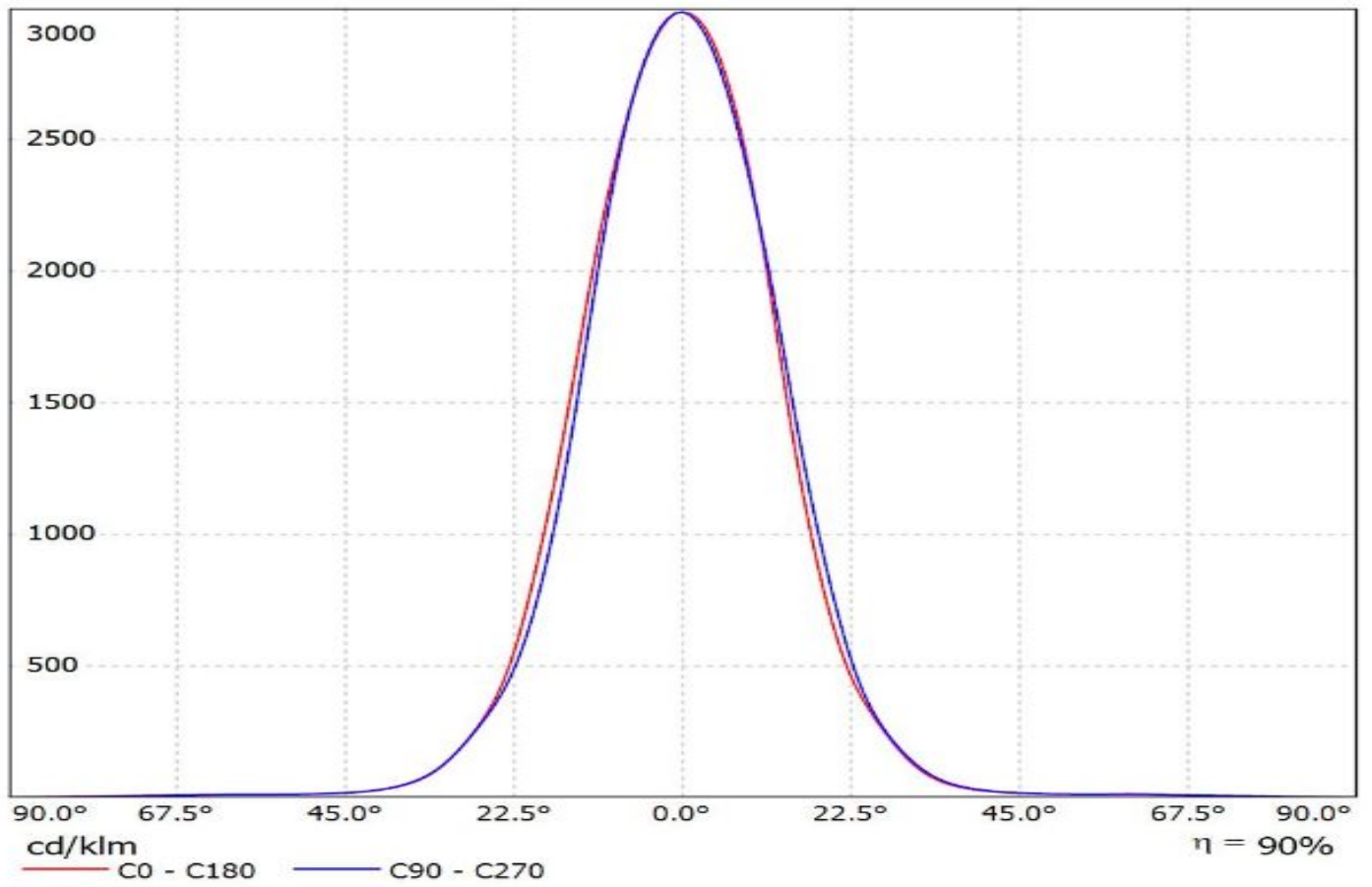

Luminaire: LEDiL Oy C13233_HB-2X2-M_(E21A) Nichia_E21A_452.248lm@250mA_2.805W_I=0.250A
Lamps: 1 x Nichia_E21A_452.248lm@250mA_2.805W_I=0.250A

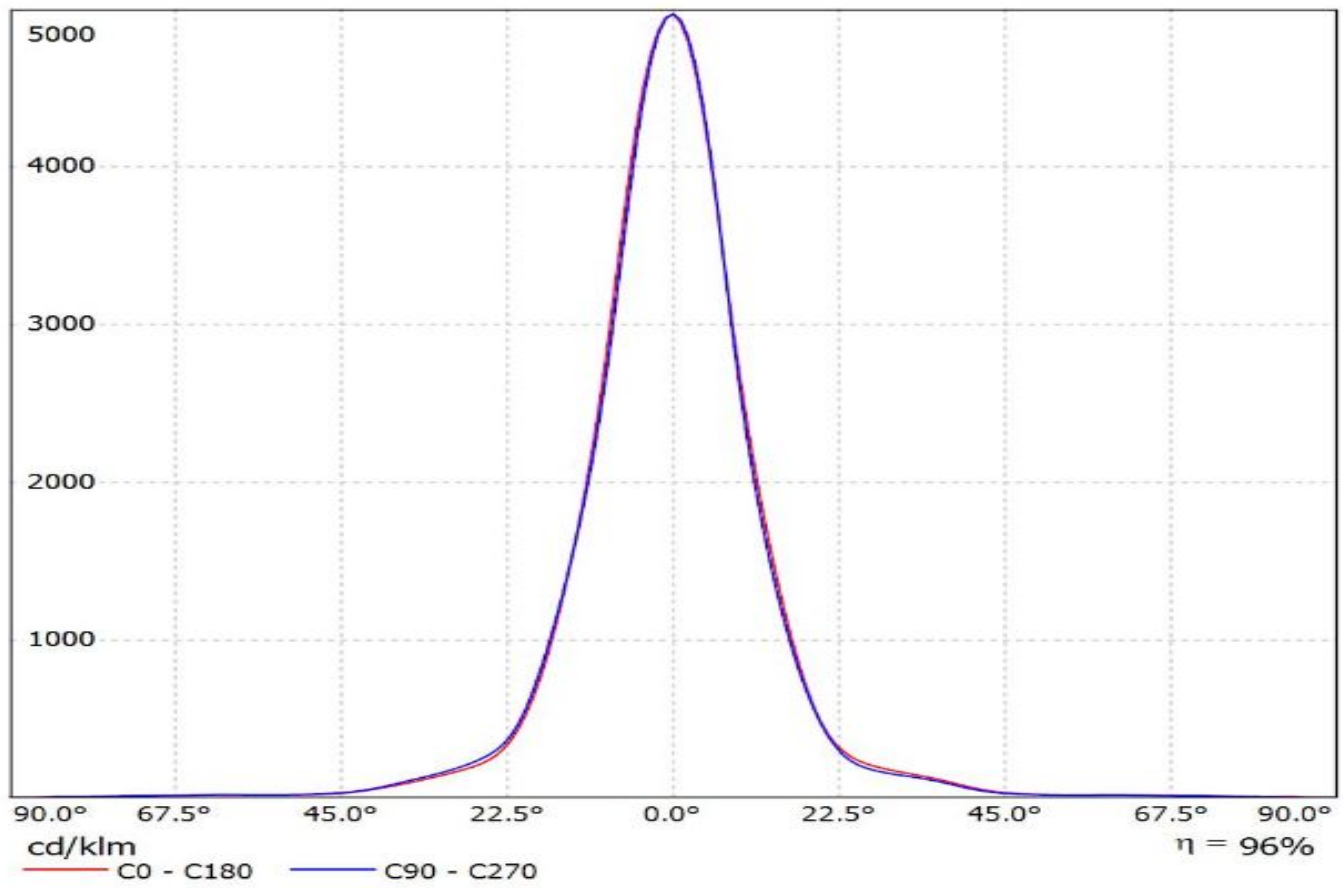

Luminaire: Ledil Oy (Osram Square PC 398lm @ 250mA) Efficiency=91%
Lamps: 1 x Osram Square PC 398lm @ 250mA

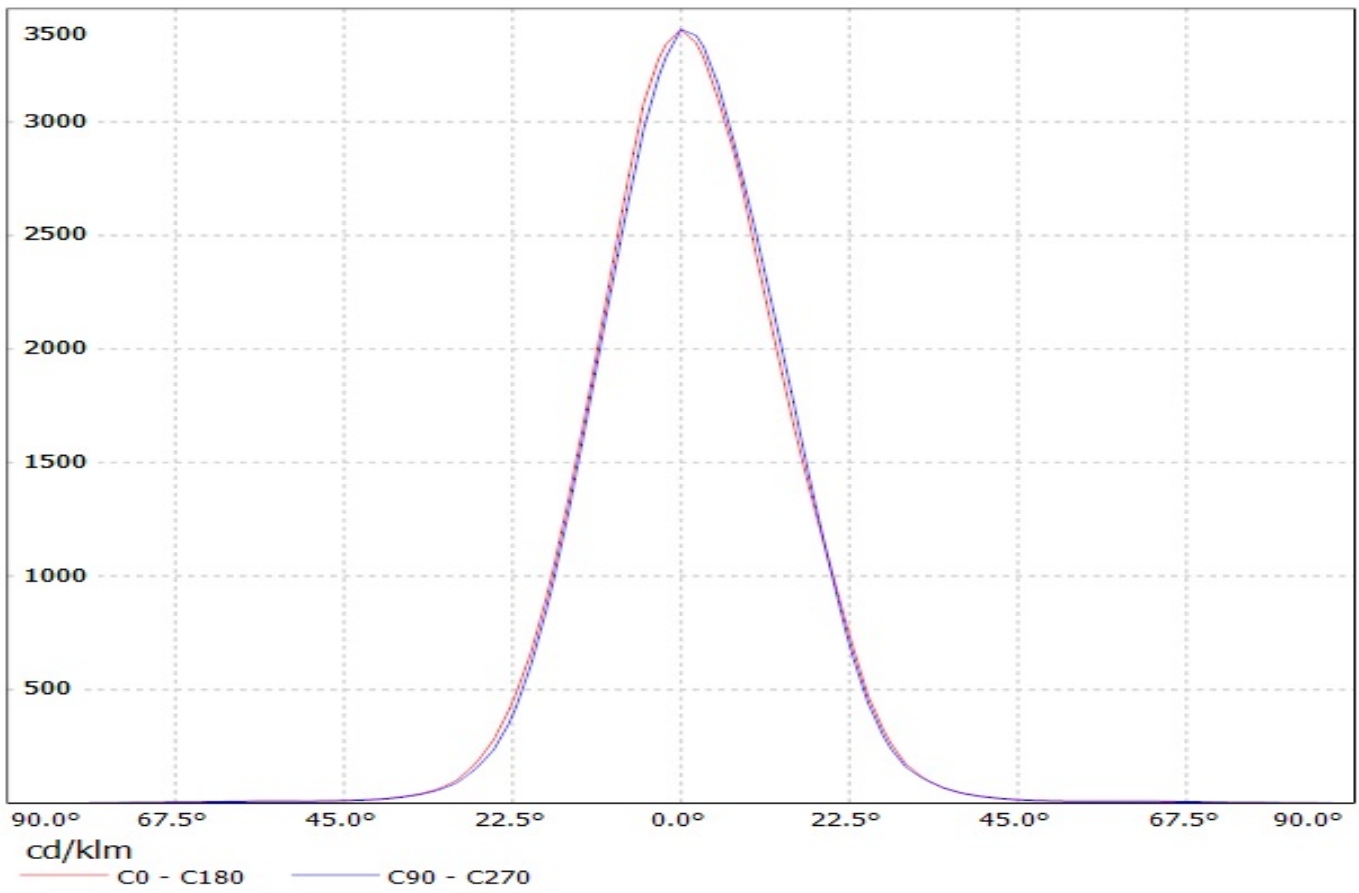

Luminaire: LEDiL Oy
Lamps: 1 x C13233-HB-2x2-M_(SQ_Gen3)

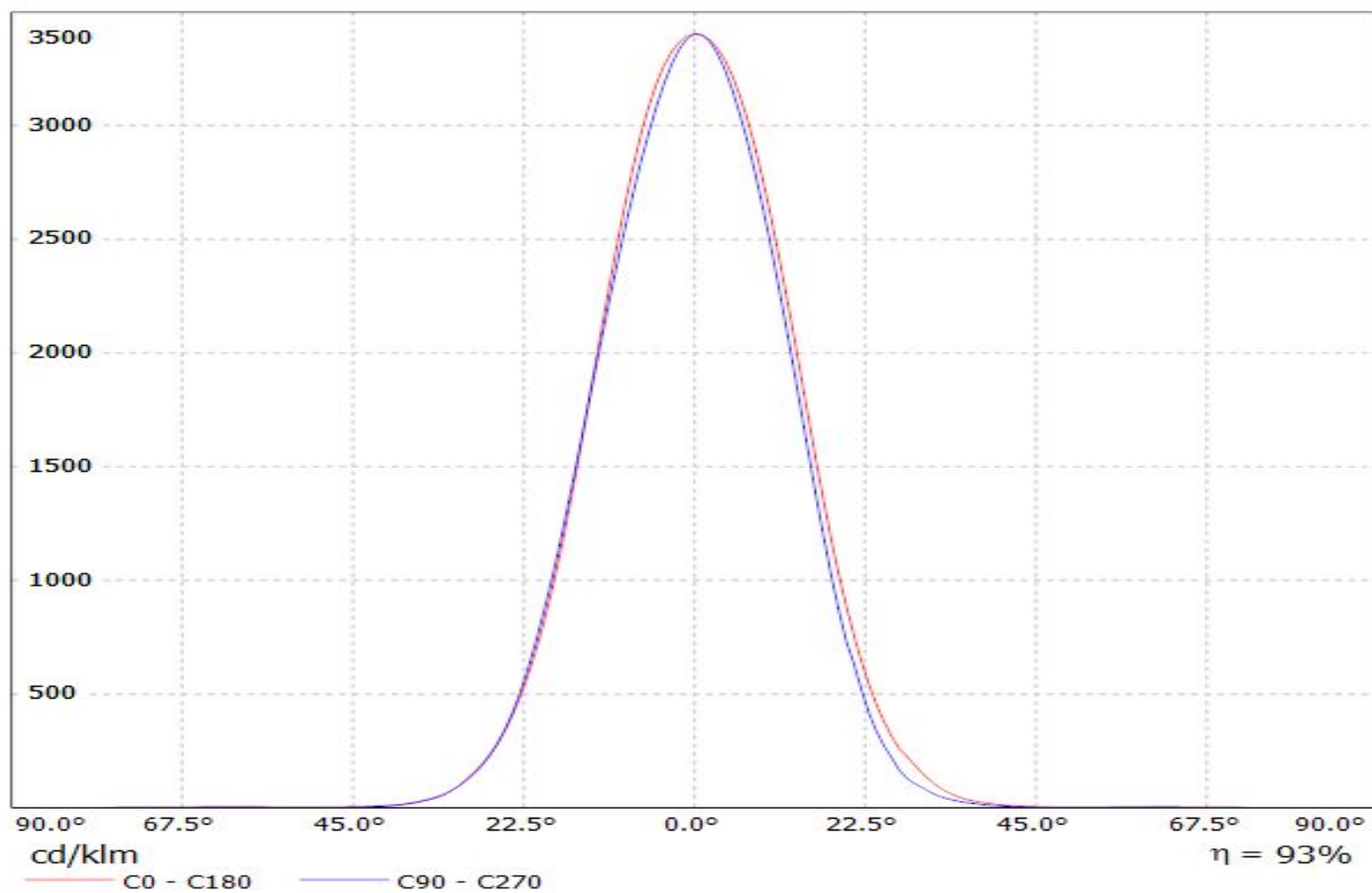

Luminaire: LEDiL Oy C13233_HB-2X2-M_(LH351Z) Eff.93.0%
Lamps: 1 x SAMSUNG_LH351Z_2x2_359.49lm@250mA_P=2.86371W_I=249.8mA

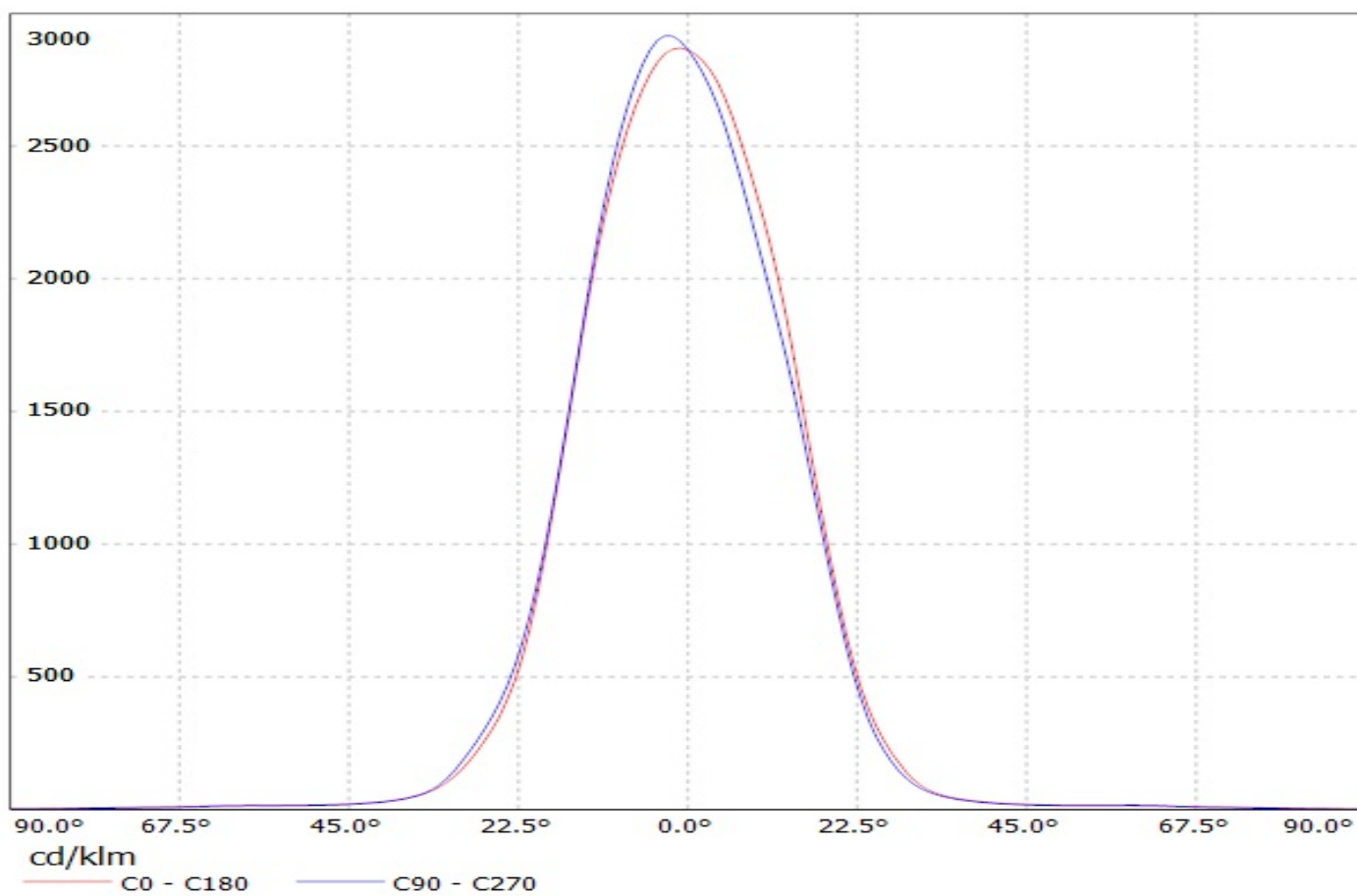

Luminaire: LEDiL Oy C13233_HB-2X2-M_(LH351B) Eff.93.6%
Lamps: 1 x SAMSUNG_LH351B_2x2_430.715lm@250mA_P=2.84311W_I=249.9mA

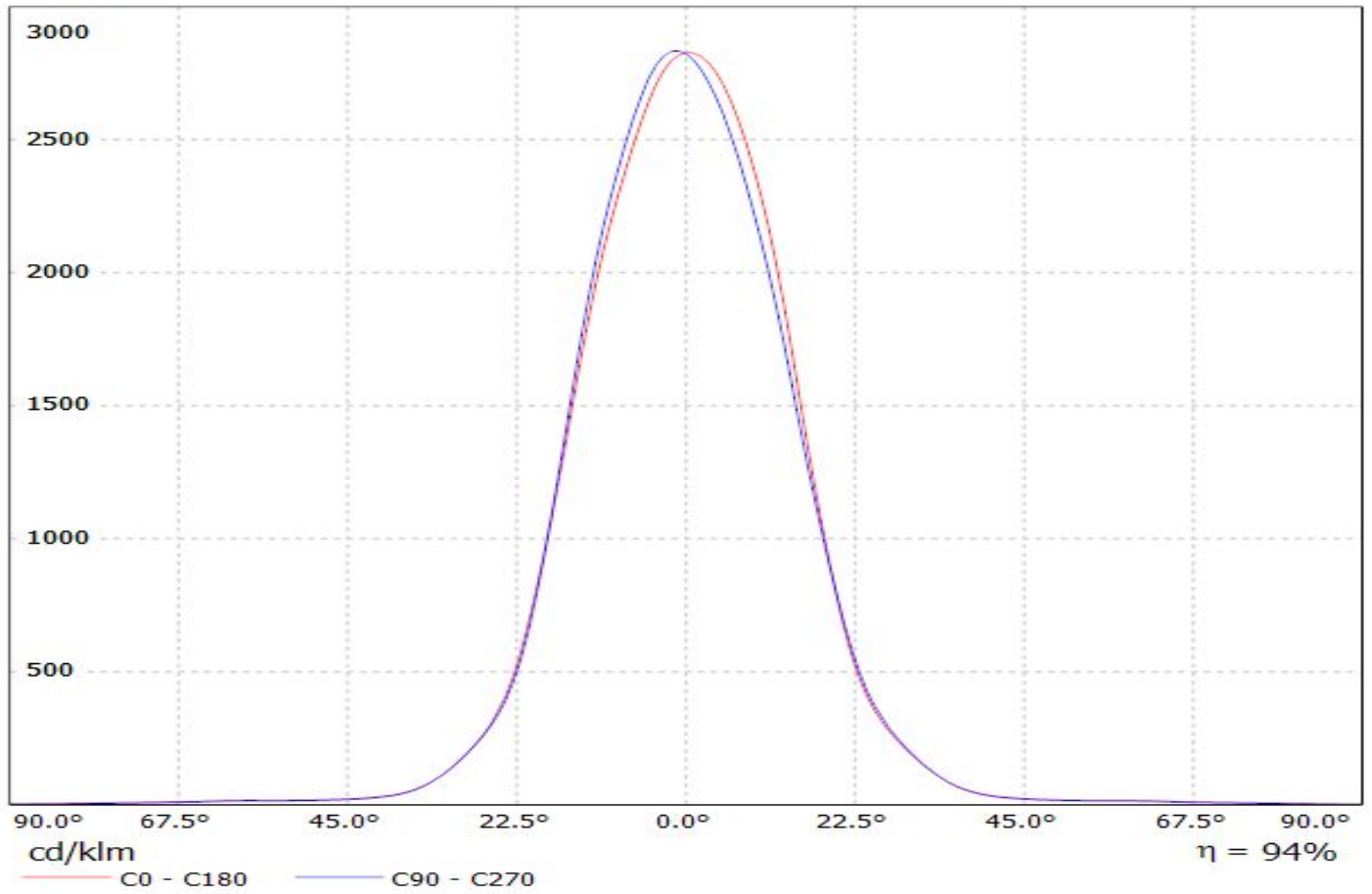

Luminaire: LEDiL Oy C13233_HB-2X2-M_(WICOP2_Z8Y15)

Lamps: 1 x SEOUL_WICOP2_Z8Y15_336.842lm@250mA_P=2.9399W_I=0.250A

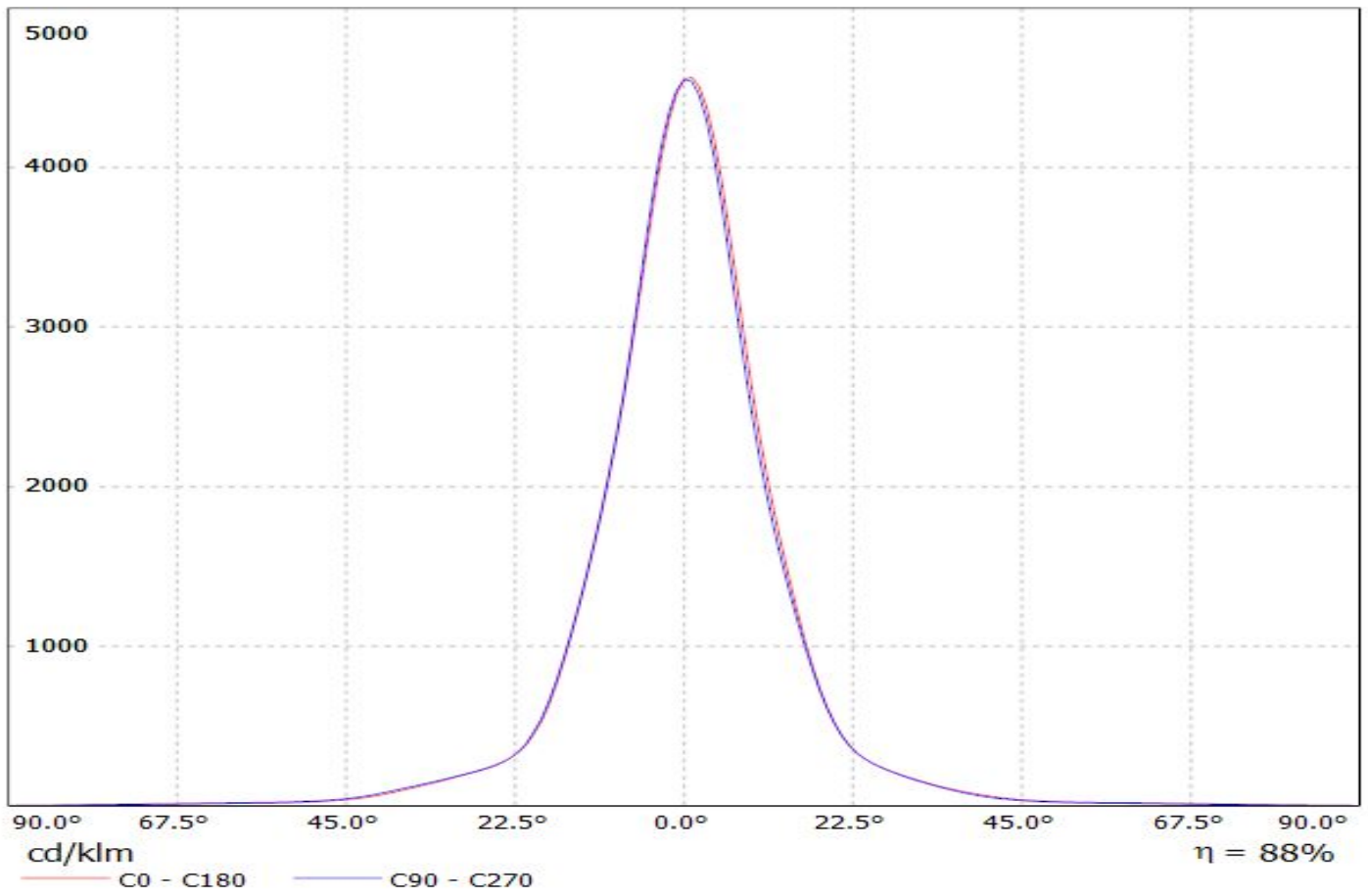

Luminaire: LEDiL Oy C13233_HB-2X2-M_(WICOP2_Z8Y19)

Lamps: 1 x SEOUL_WICOP2_Z8Y19_450.124lm@250mA_P=2.8579W_I=0.250A

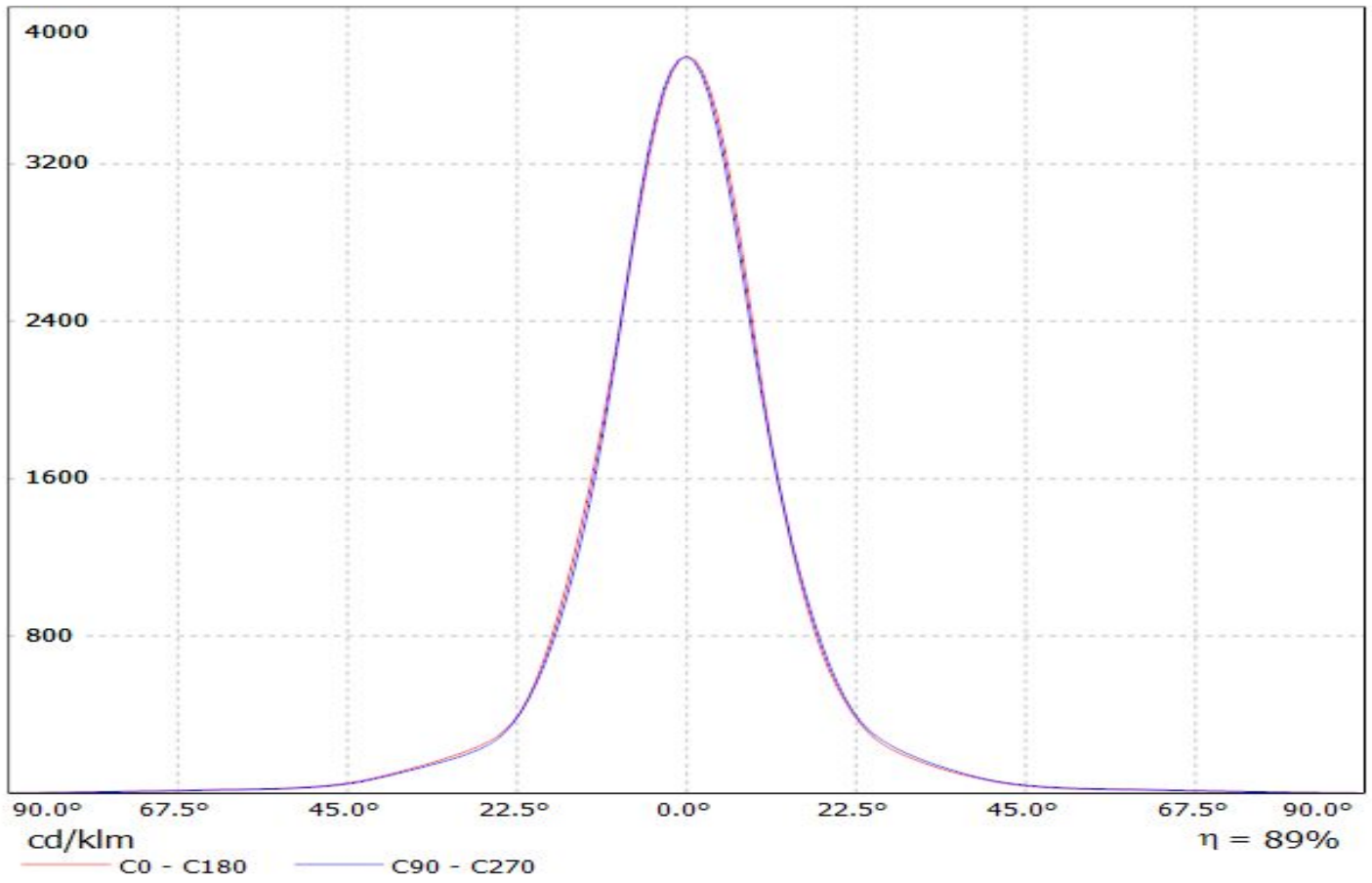

Ledil C13233_HB-2X2-M_(TL1L4) / LDC (Linear)

Luminaire: Ledil C13233_HB-2X2-M_(TL1L4)

Lamps: 1 x Toshiba_TL1L4_2x2_(TL1L4-DW0)_472.639lm@250mA_CCT=6500K_P=2.9W_I=0.25A

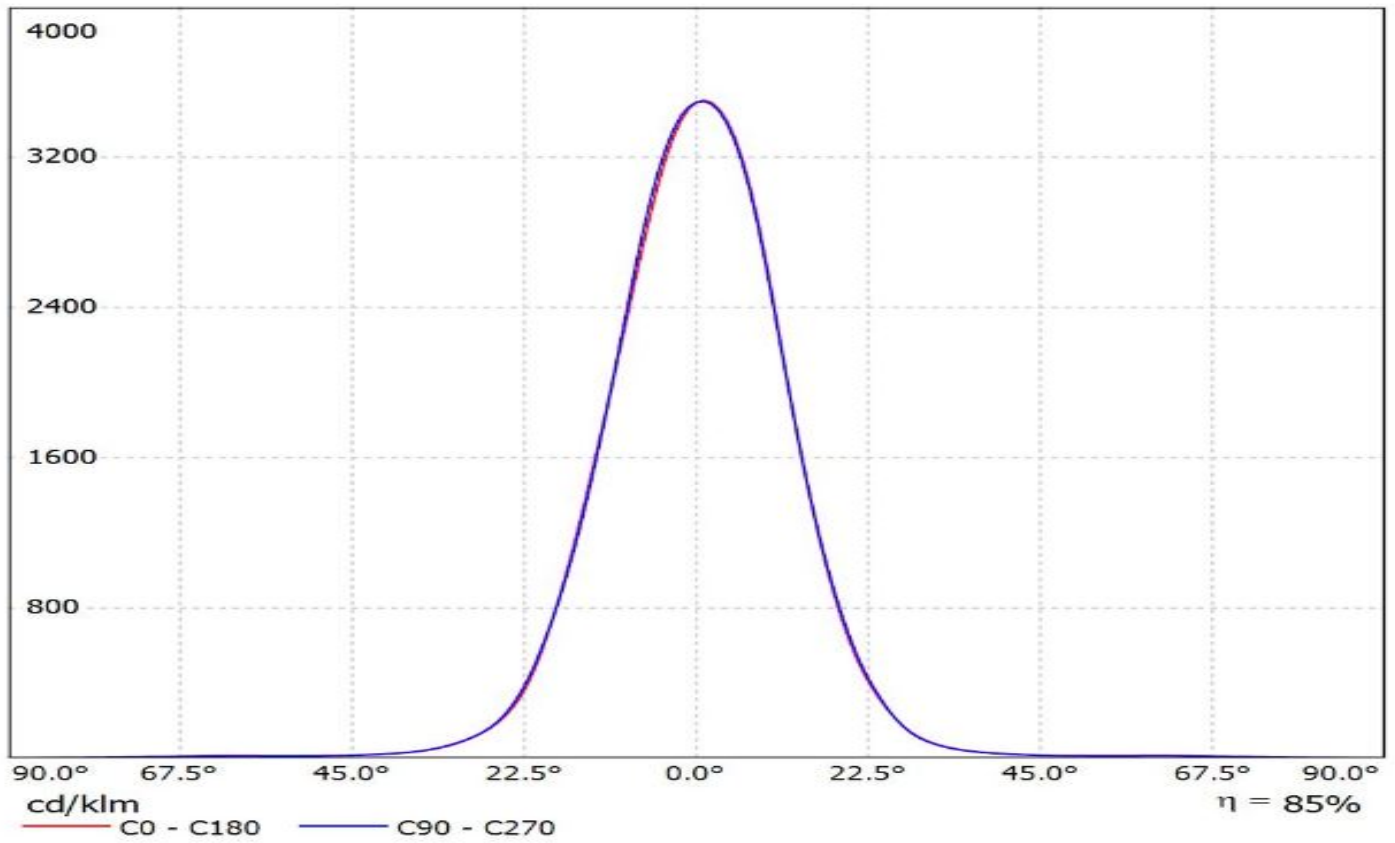

Luminaire: LEDiL Oy C13233_HB-2X2-M_(Tridonic_Module_RLE_G1)
Lamps: 1 x Tridonic_Module_RLE_G1_4576.03lm@700mA_P=32.0681W_I=0.700A

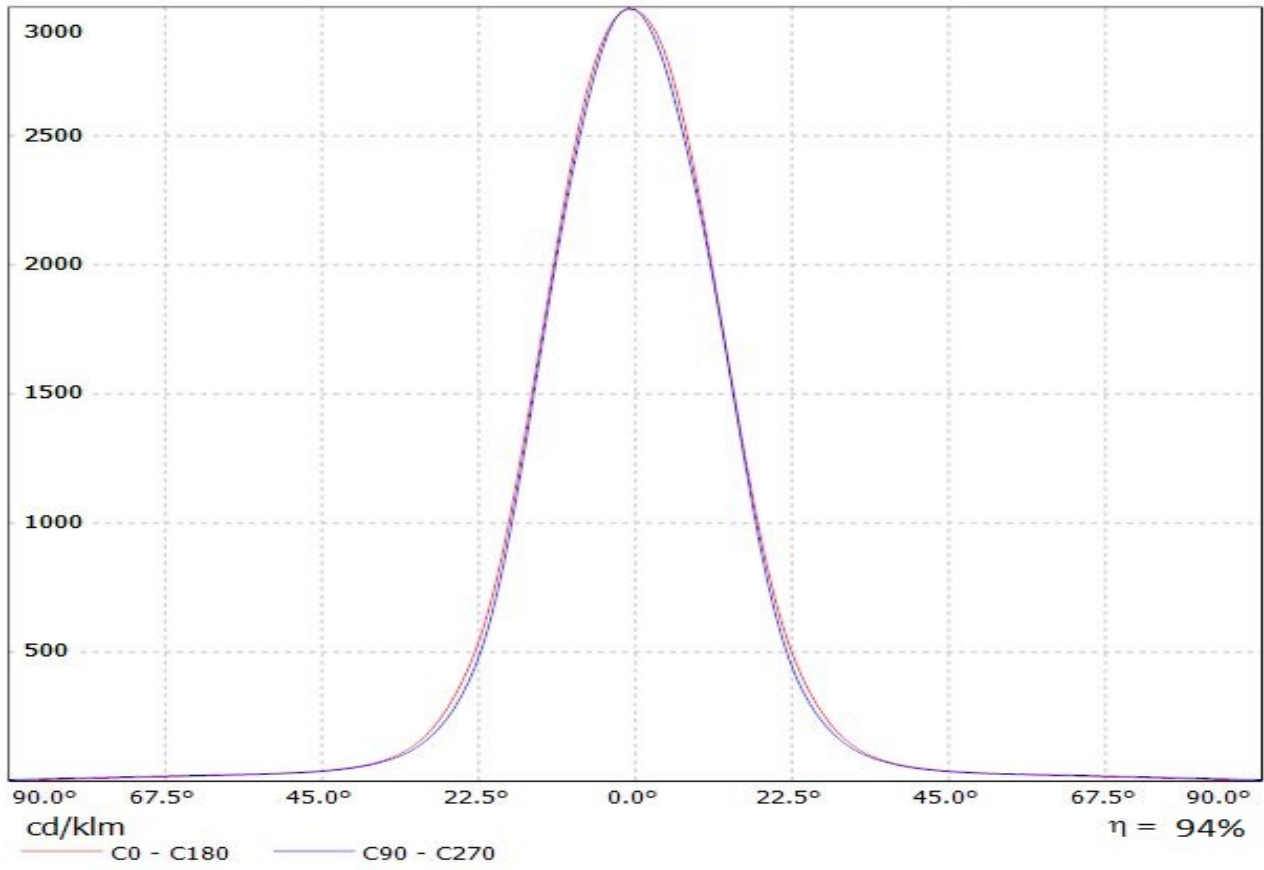

Luminaire: LEDiL Oy C13233_HB-2X2-M_(Tridonic_Module_RLE_G1)
Lamps: 1 x Tridonic_Module_RLE_G1_4576.03lm@700mA_P=32.0681W_I=0.700A

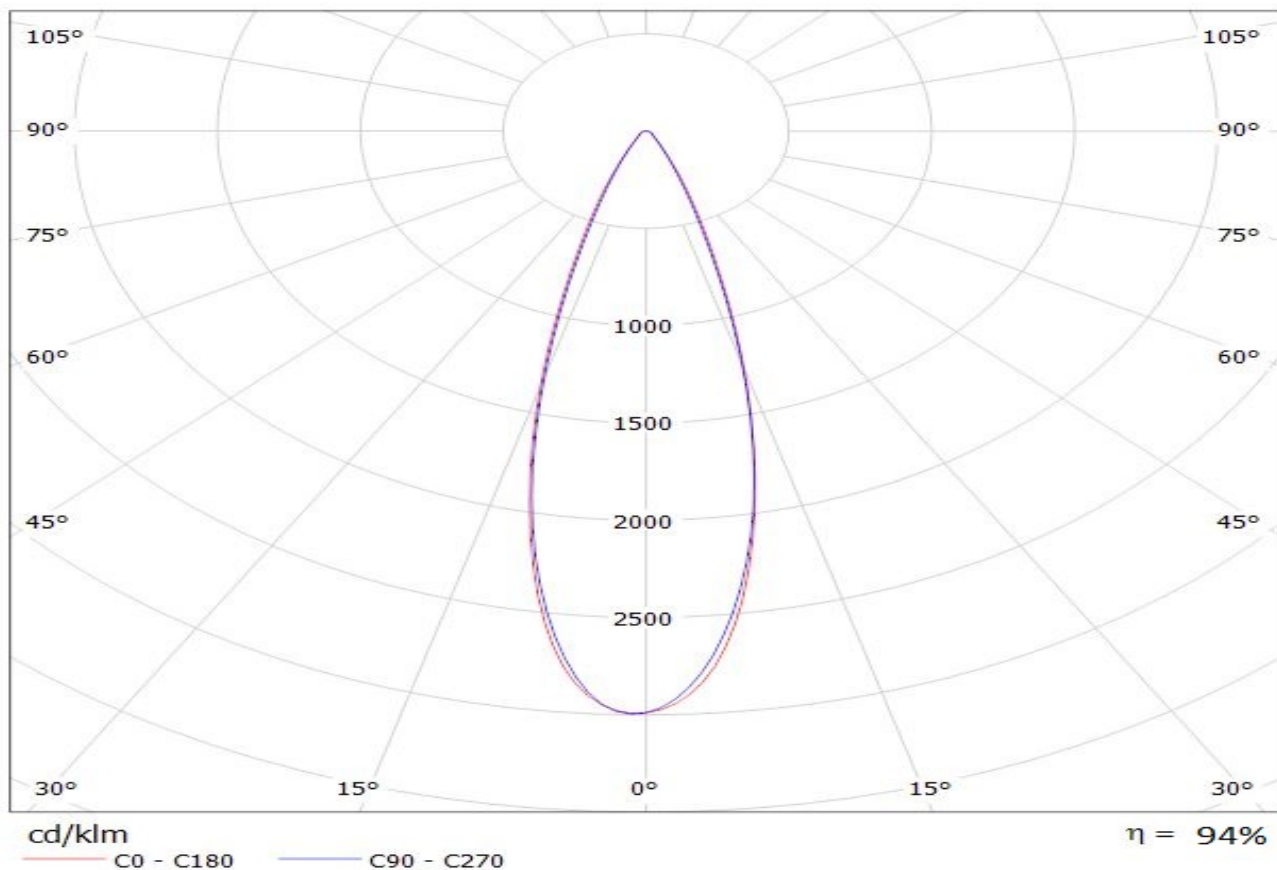

Luminaire: LEDiL Oy C13233_HB-2X2-M_(Tridonic_Module_RLE_G1)
Lamps: 1 x Tridonic_Module_RLE_G1_2288lm@700mA_P=16W_I=0.700A

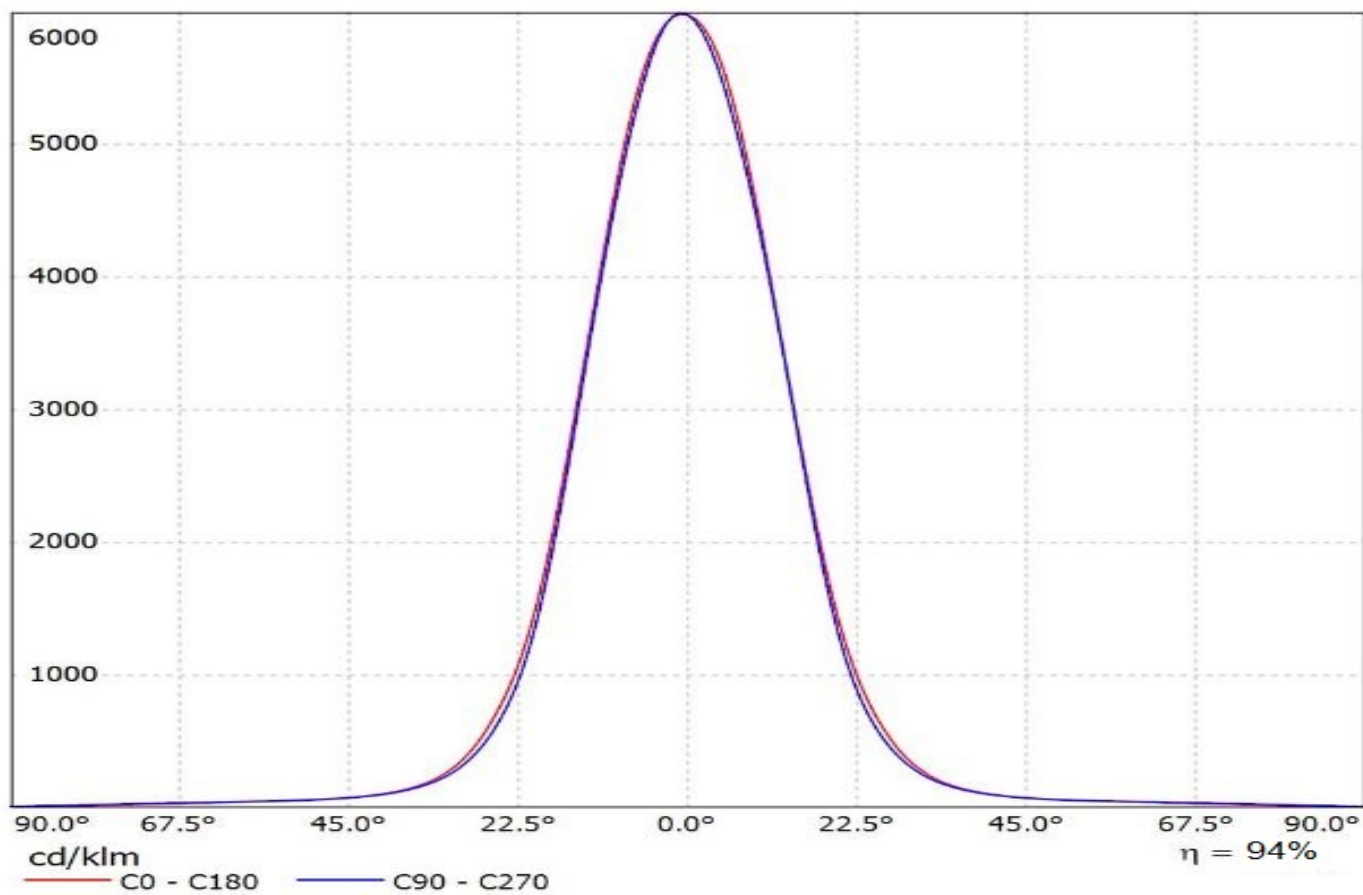

Luminaire: LEDiL Oy C13233_HB-2X2-M_(Tridonic_Module_RLE_G1)
Lamps: 1 x Tridonic_Module_RLE_G1_2288lm@700mA_P=16W_I=0.700A

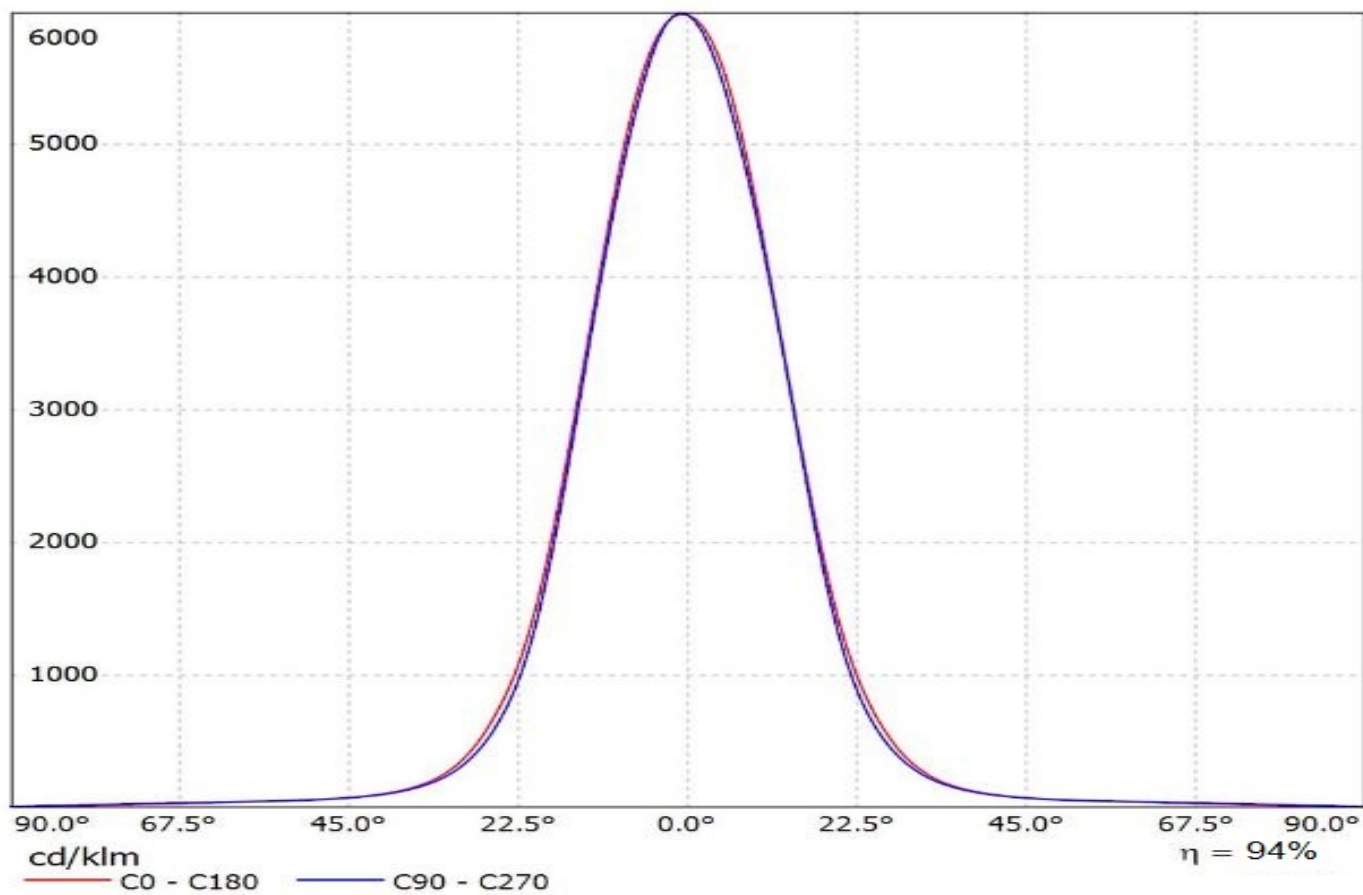

Luminaire: Ledil Oy C13233_HB-2x2-M (Cree XT-E 390lm @ 250mA) Efficiency=92%
Lamps: 1 x Cree XT-E 390lm @ 250mA

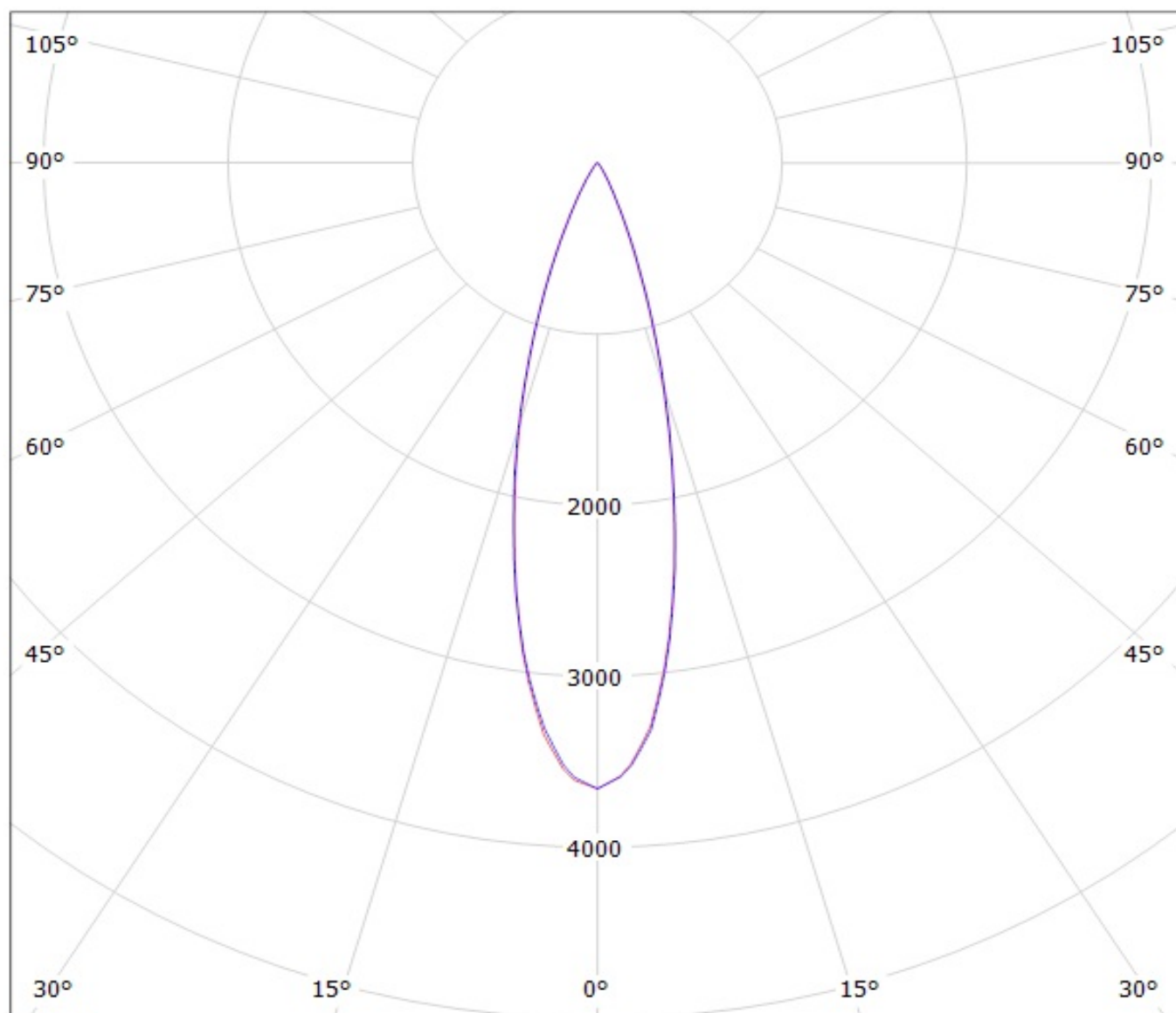

cd/klm

— C0 - C180

— C90 - C270

Luminaire: Ledil Oy C13233_HB-2x2-M (Cree XP-G 257lm @ 250mA) Efficiency=91%
Lamps: 1 x Cree XP-G 257lm @ 250mA

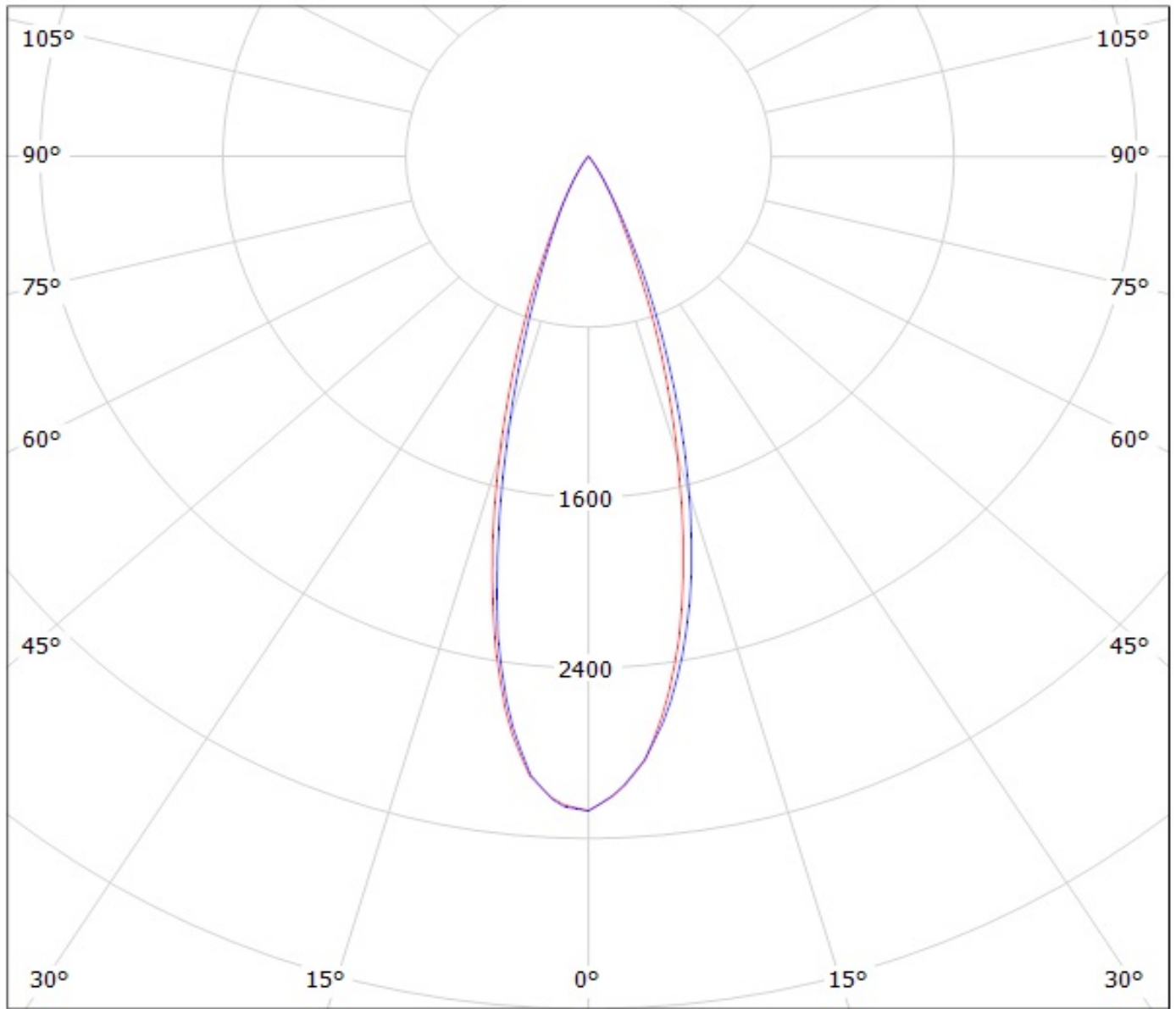

cd/klm
— C0 - C180 — C90 - C270

Luminaire: Ledil Oy C13233_HB-2x2-M (Cree XP-G2 420lm @ 250mA) Efficiency=93%
Lamps: 1 x Cree XP-G2 420lm @ 250mA

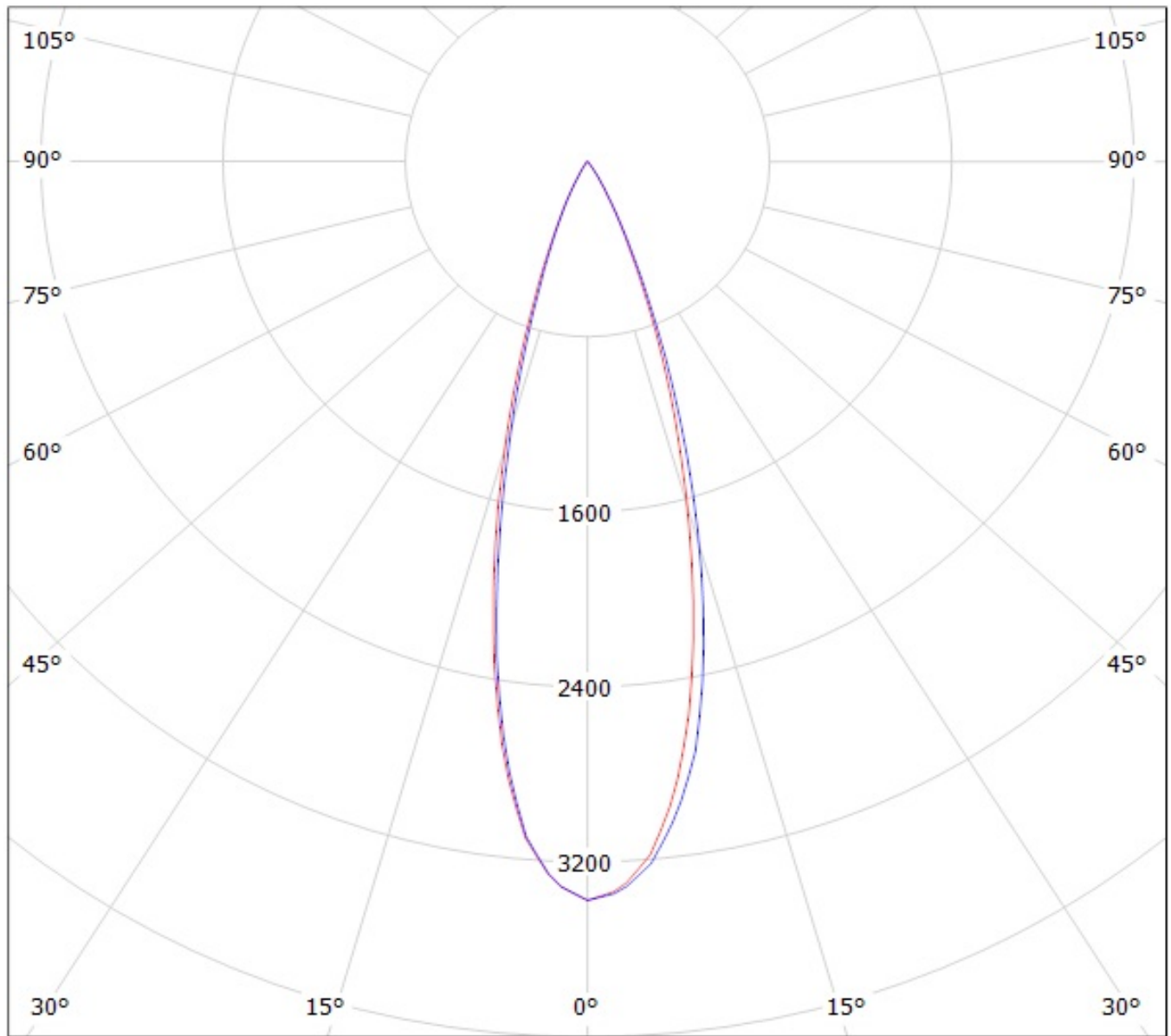

cd/klm

— C0 - C180

— C90 - C270

LEDiL Oy C13233_HB-2x2-M_(XB-D) Eff.95.2% / LDC (Polar)

Luminaire: LEDiL Oy C13233_HB-2x2-M_(XB-D) Eff.95.2%

Lamps: 1 x CREE_XB-D_2x2 (362.885lm@250mA)

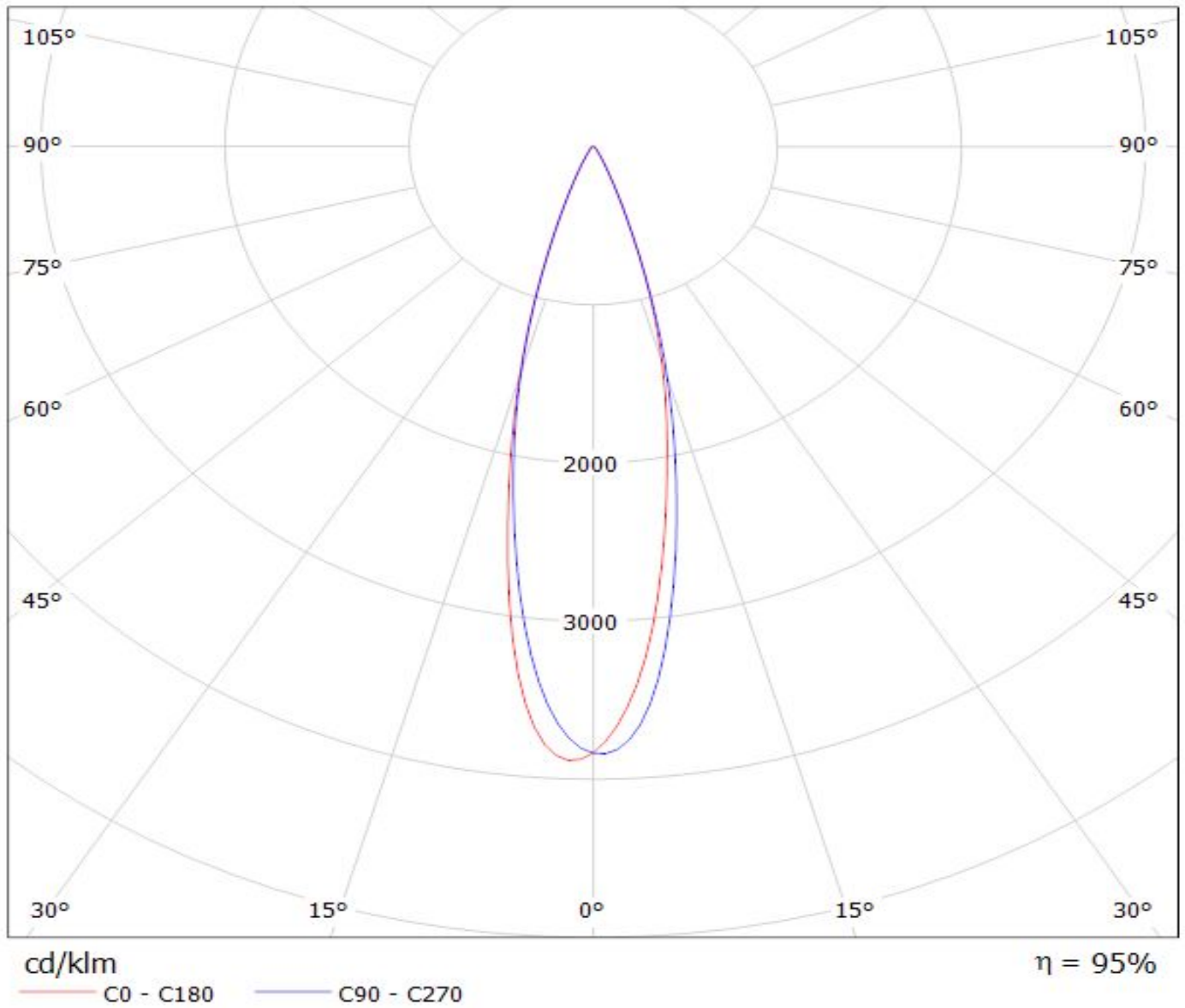

Luminaire: Ledil C13233_HB-2x2-M_(XP-G3)

Lamps: 1 x Cree_XP-G3_2x2_(XPGDWT-B1-3C0-S4-0-01)_516.459lm@250mA_P=2.7885W_I=0.25A

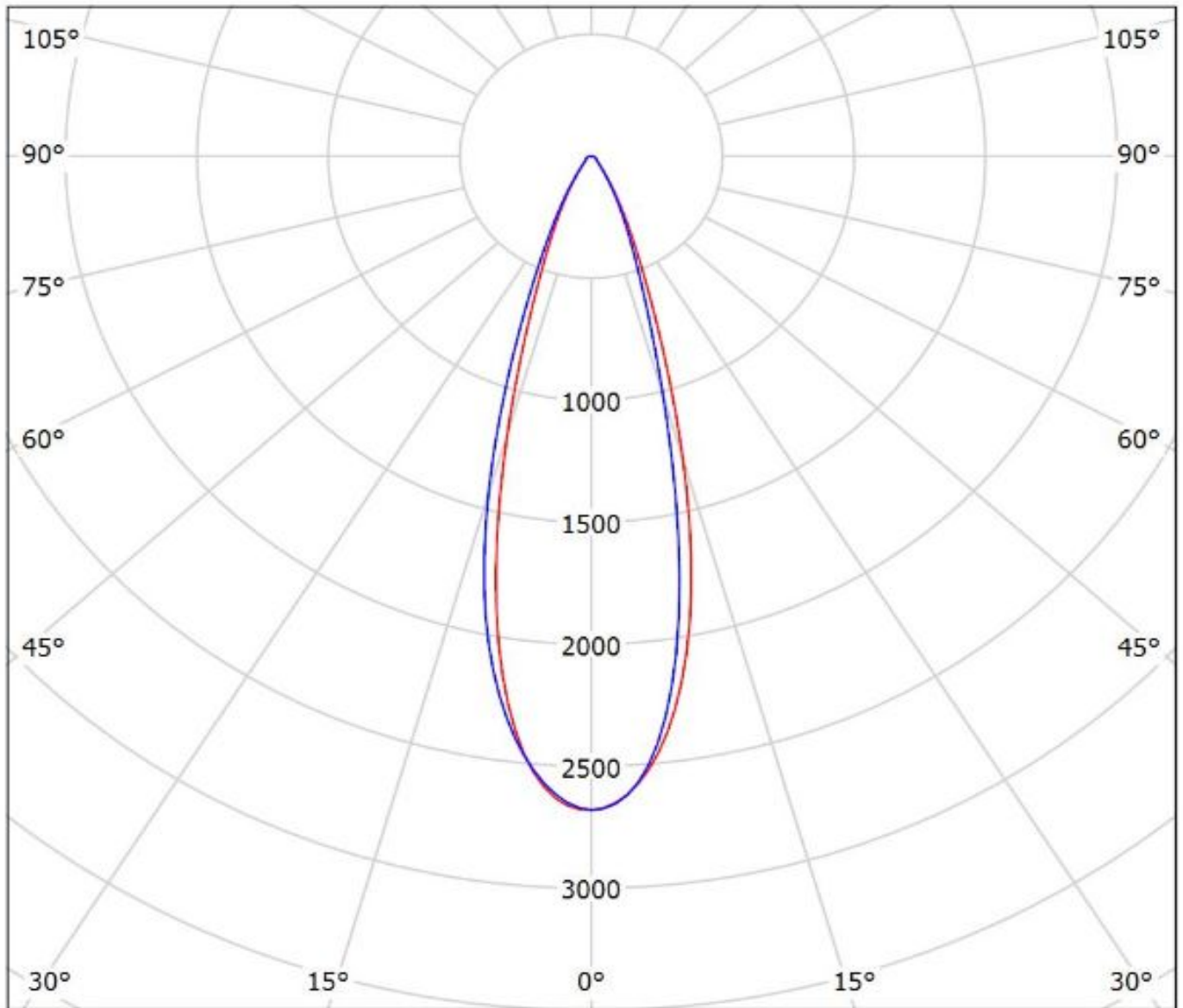

cd/klm

— C0 - C180

— C90 - C270

$\eta = 95\%$

Luminaire: Ledil Oy C13233_HB-2x2-M_(3535_Ceramic_gen2) Efficiency=91%
Lamps: 1 x LG 3535 Ceramic gen2 (PKG5700K) 461lm @ 250mA CCT=6600K P=2.9W I=250mA

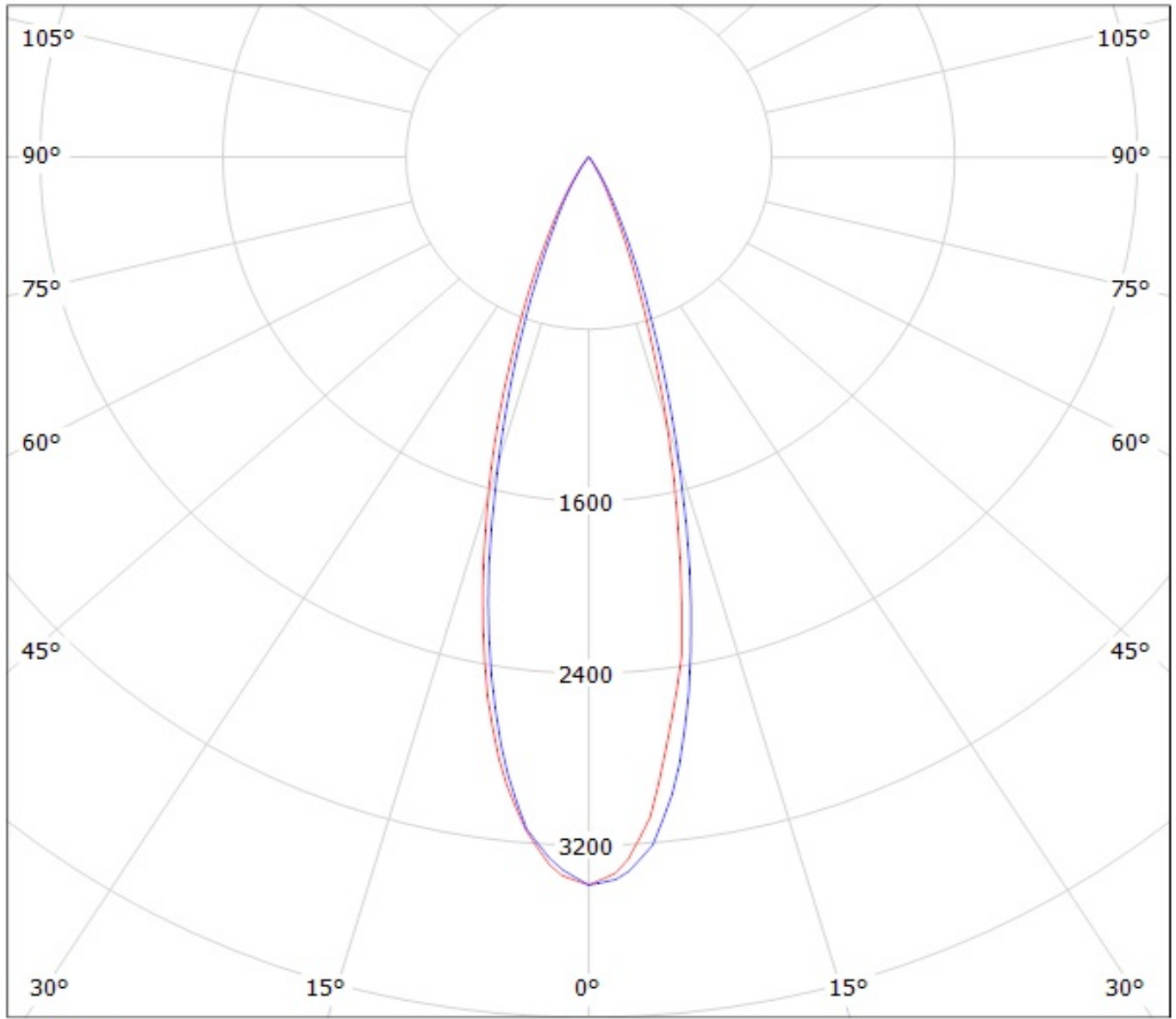

cd/klm

— C0 - C180 — C90 - C270

Luminaire: Ledil Oy C13233_HB-2X2-M_(Luxeon_Z_ES) Efficiency=91%
Lamps: 1 x Luxeon Z ES (LXZ2-3090) 209lm @ 250mA CCT=3000K P=2.8W I=250mA

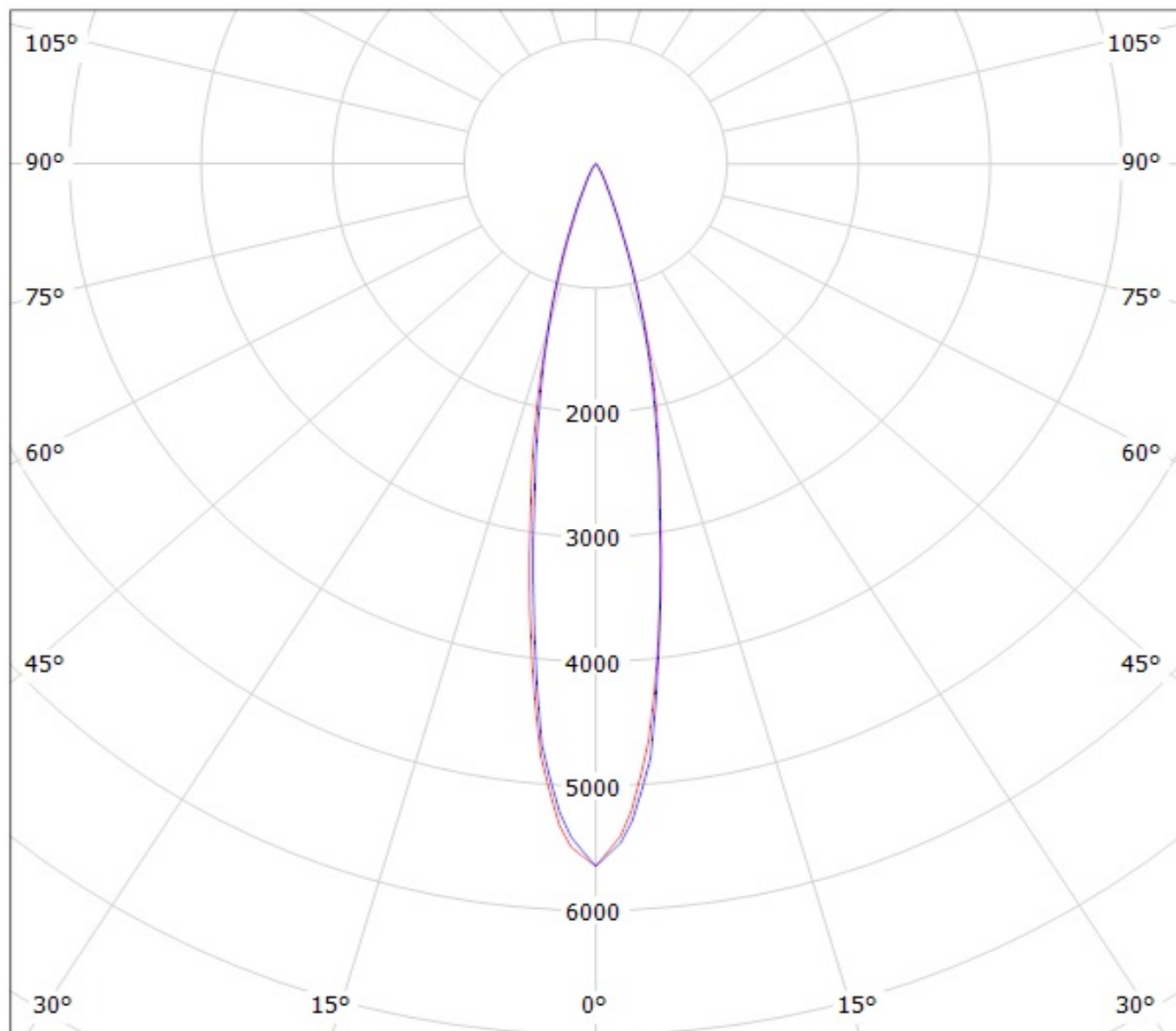

cd/klm

— C0 - C180 — C90 - C270

Luminaire: LEDiL Oy C13233_HB-2X2-M_(LUXEON_Q)

Lamps: 1 x LUXEON_Q_2x2_(LHQ-3080)_298.363lm@250mA_P=2.87385W_I=249.9mA

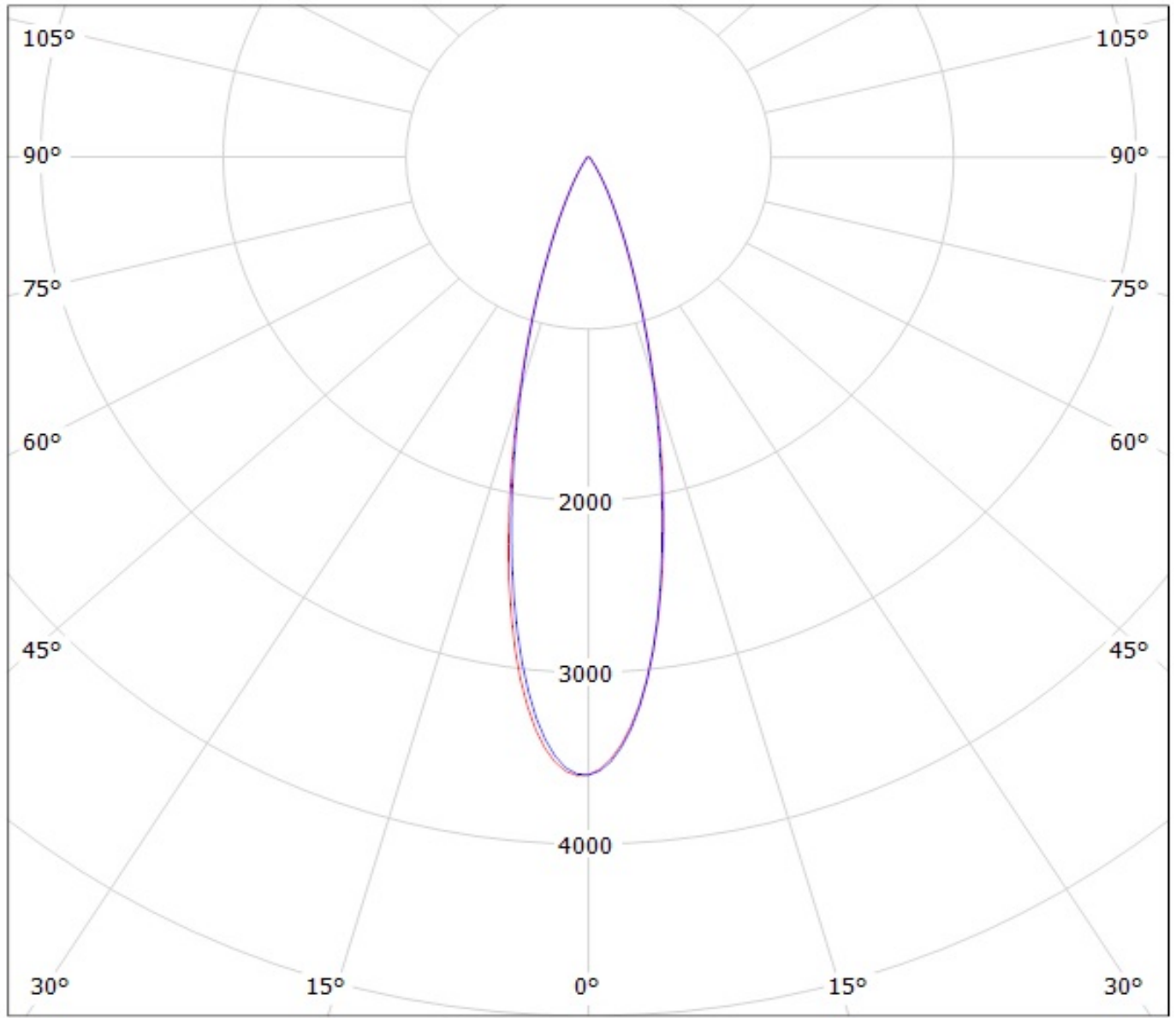

cd/klm

— C0 - C180

— C90 - C270

Luminaire: Ledil Oy C13233_HB-2x2-M (Nichia 219B 306lm @ 250mA) Efficiency=91%
Lamps: 1 x Nichia 219B 306lm @ 250mA

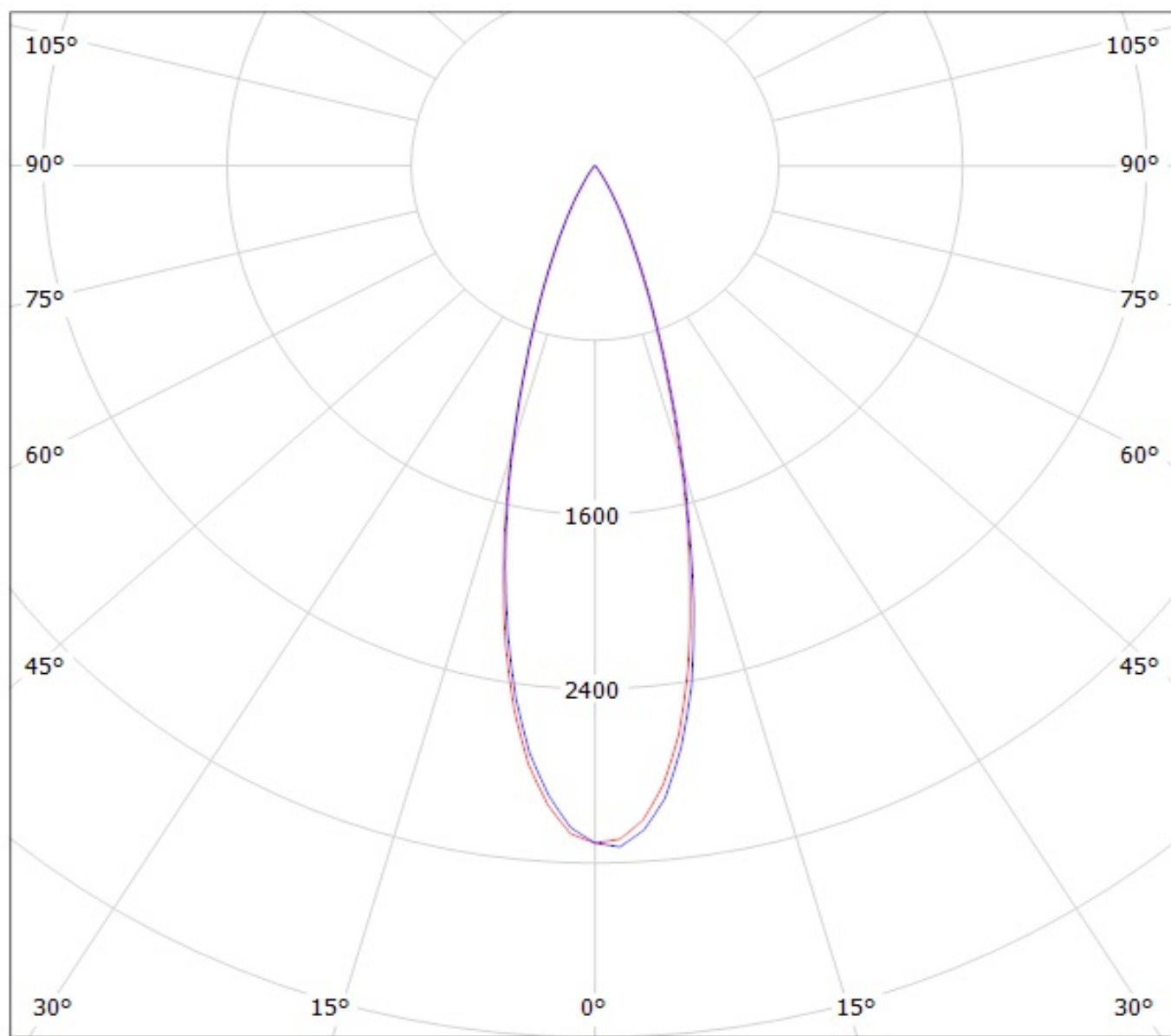

cd/klm

— C0 - C180

— C90 - C270

Luminaire: Ledil C13233-HB_2x2-M_(NVSL219CE)

Lamps: 1 x Nichia_NVSL219CE_496.405lm@250mA_CCT=4000K_P=2.8465W_I=0.25A

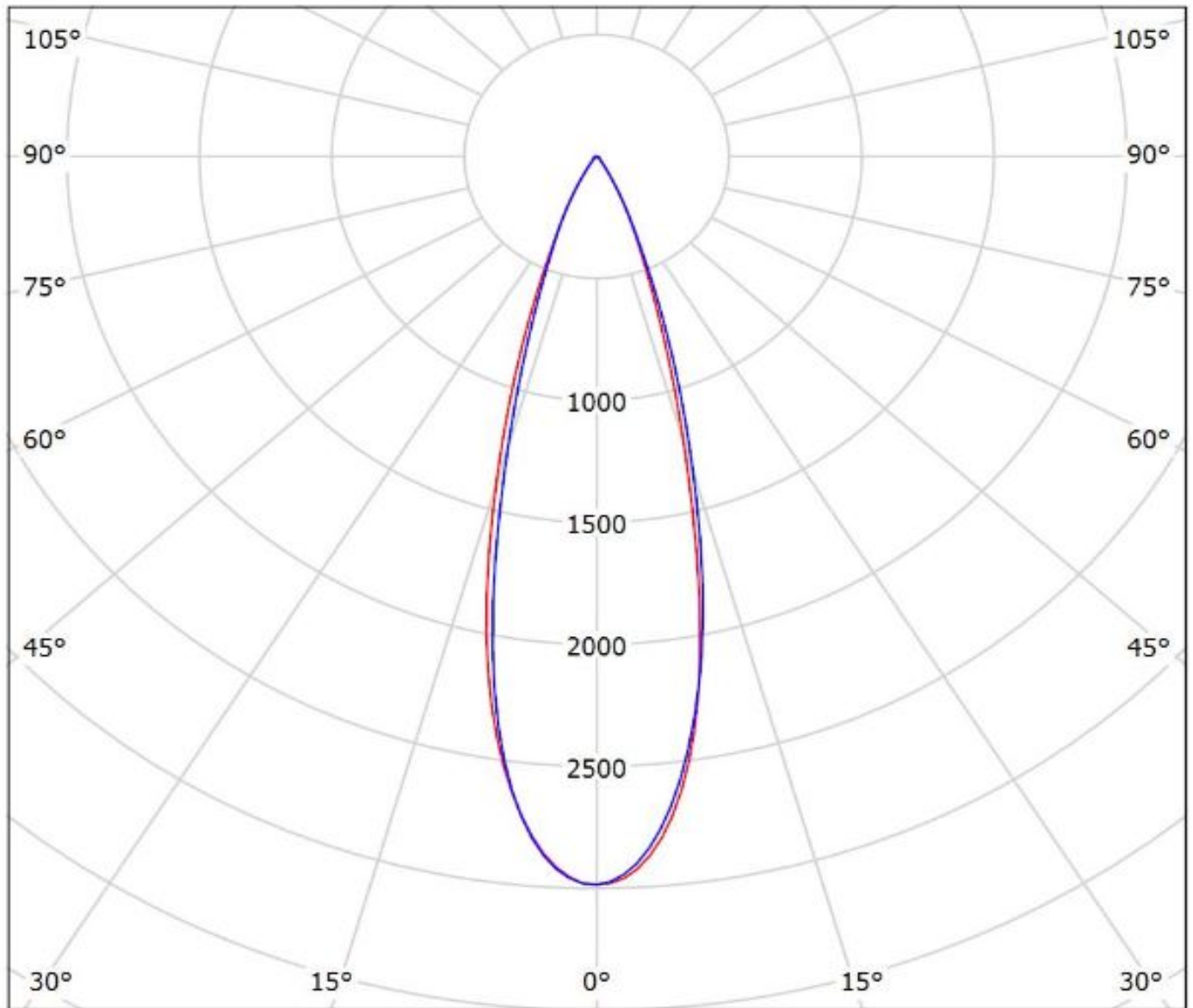

cd/klm

— C0 - C180

— C90 - C270

$\eta = 90\%$

Luminaire: LEDiL Oy C13233_HB-2X2-M_(E21A) Nichia_E21A_452.248lm@250mA_2.805W_I=0.250A
Lamps: 1 x Nichia_E21A_452.248lm@250mA_2.805W_I=0.250A

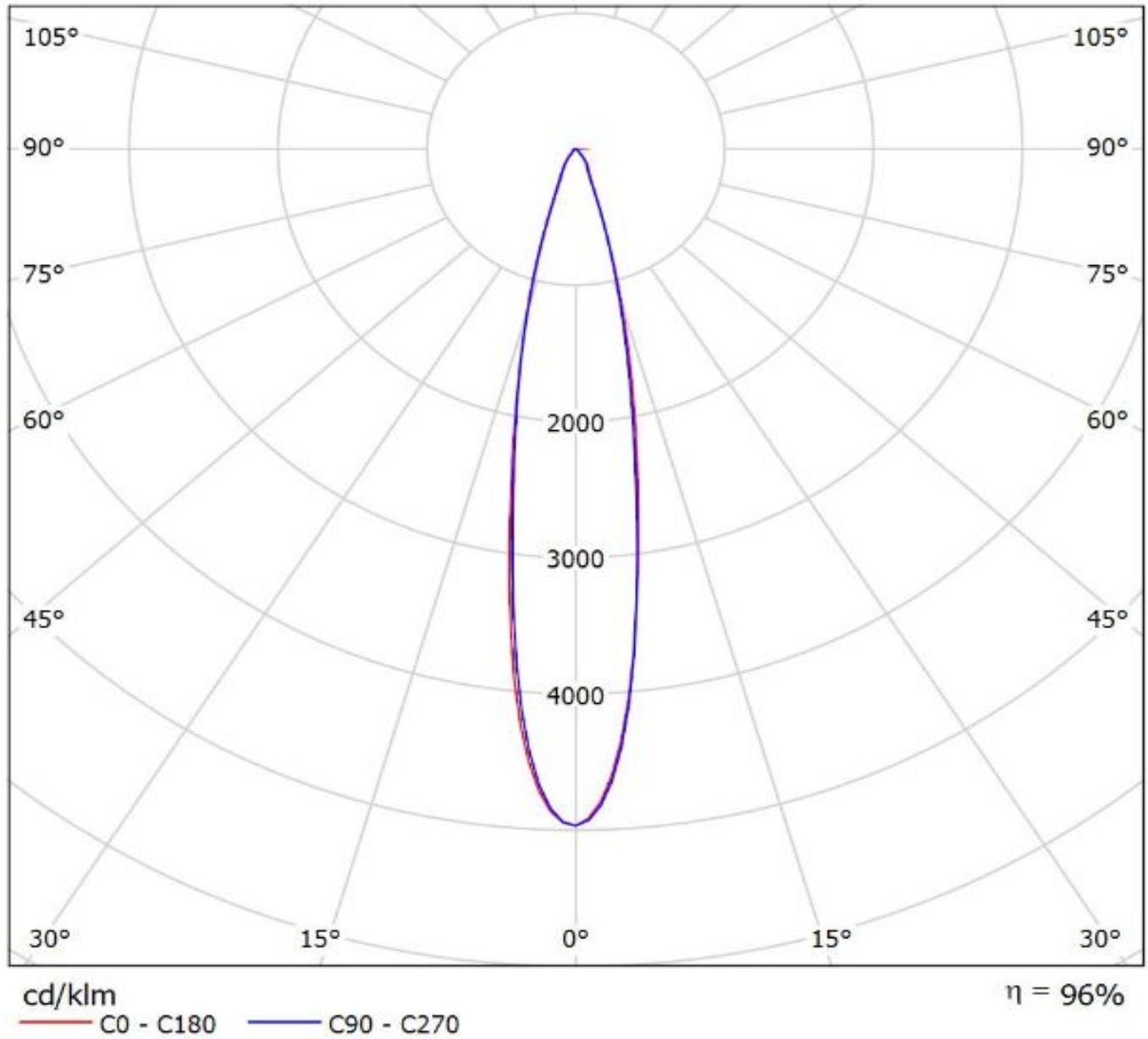

Luminaire: Ledil Oy (Osram Square PC 398lm @ 250mA) Efficiency=91%
Lamps: 1 x Osram Square PC 398lm @ 250mA

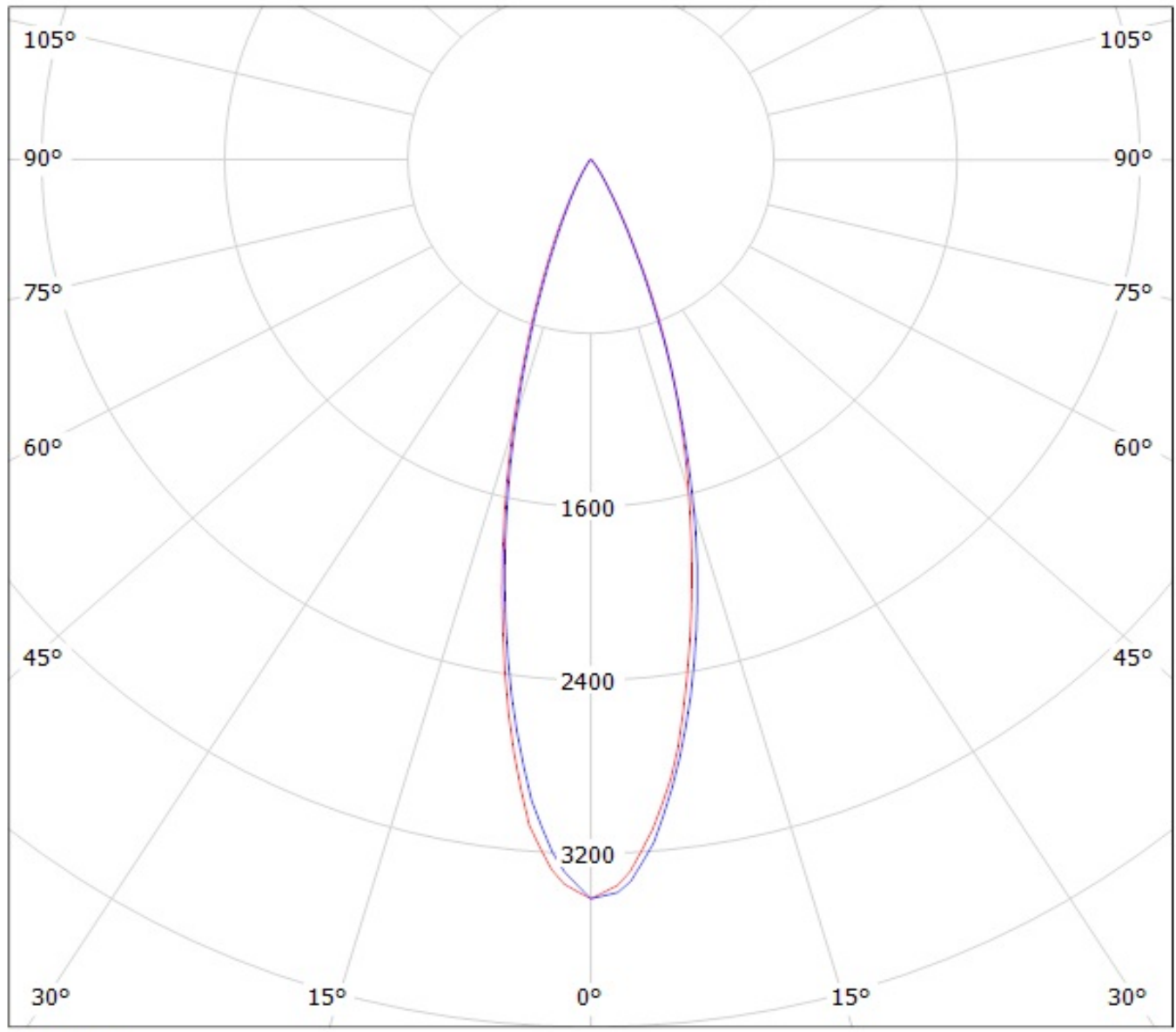

cd/klm
— C0 - C180 — C90 - C270

Luminaire: LEDiL Oy
Lamps: 1 x C13233-HB-2x2-M_(SQ_Gen3)

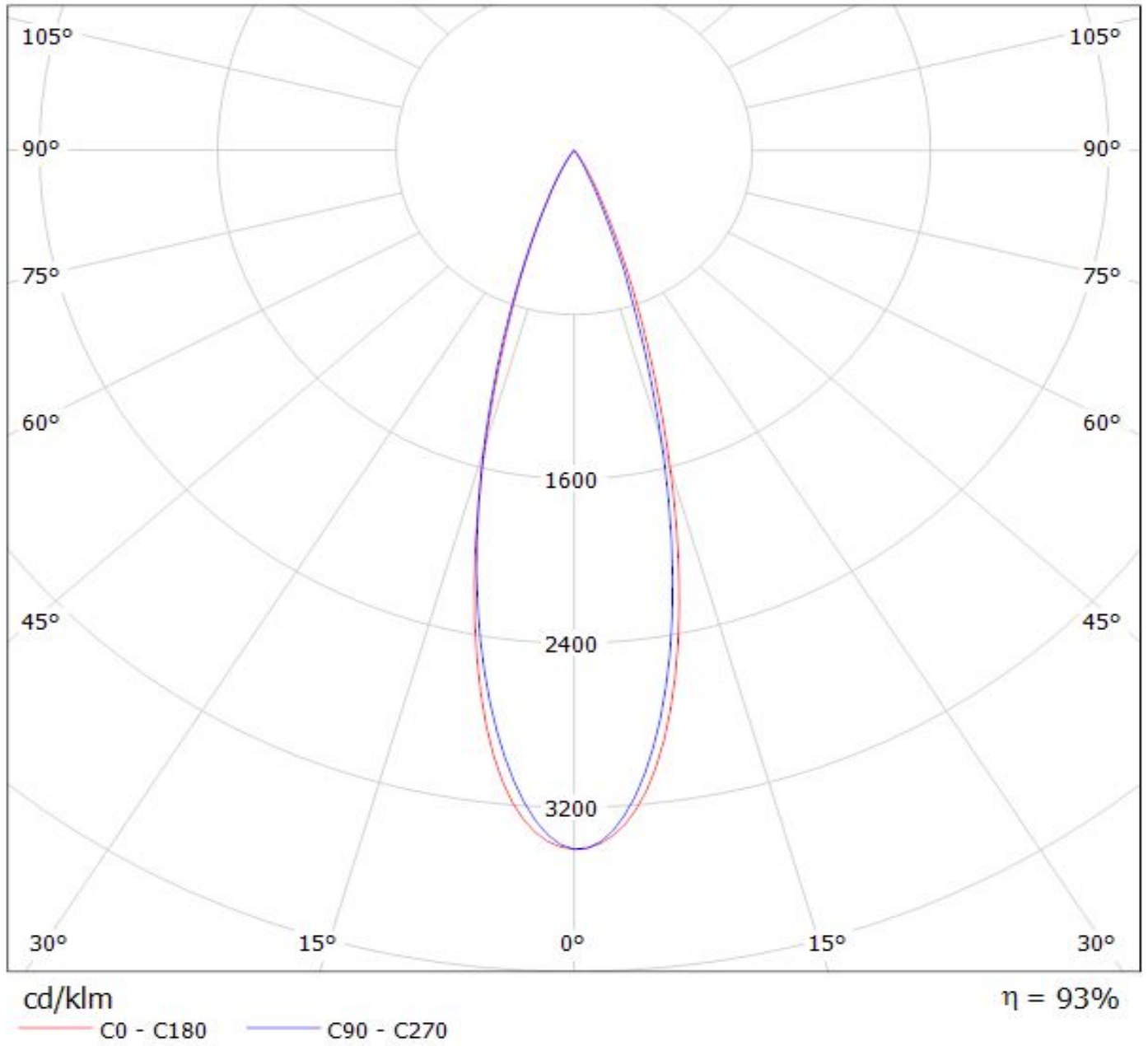

Luminaire: LEDiL Oy C13233_HB-2X2-M_(LH351Z) Eff.93.0%

Lamps: 1 x SAMSUNG_LH351Z_2x2_359.49lm@250mA_P=2.86371W_I=249.8mA

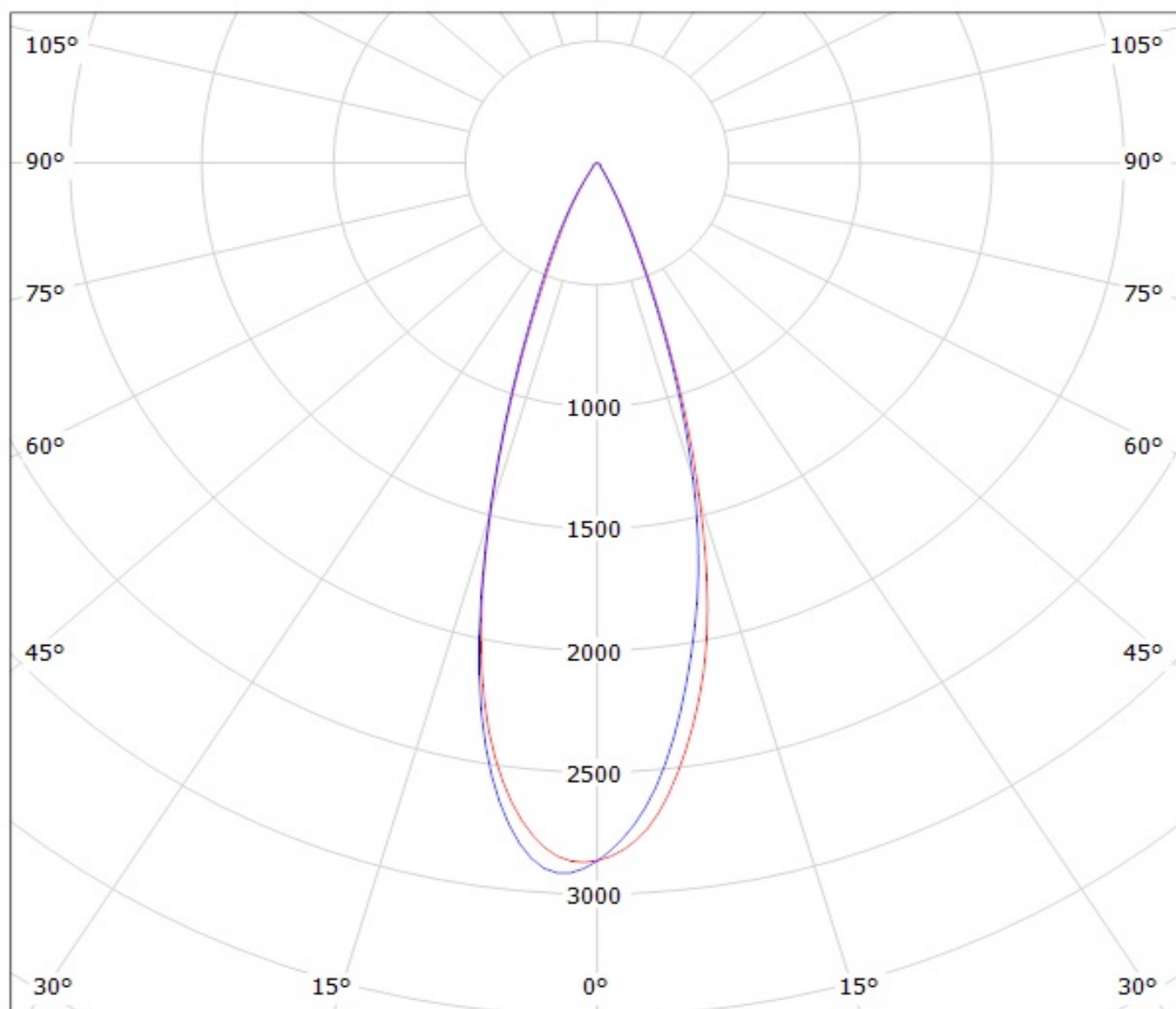

cd/klm

— C0 - C180

— C90 - C270

Luminaire: LEDiL Oy C13233_HB-2X2-M_(LH351B) Eff.93.6%

Lamps: 1 x SAMSUNG_LH351B_2x2_430.715lm@250mA_P=2.84311W_I=249.9mA

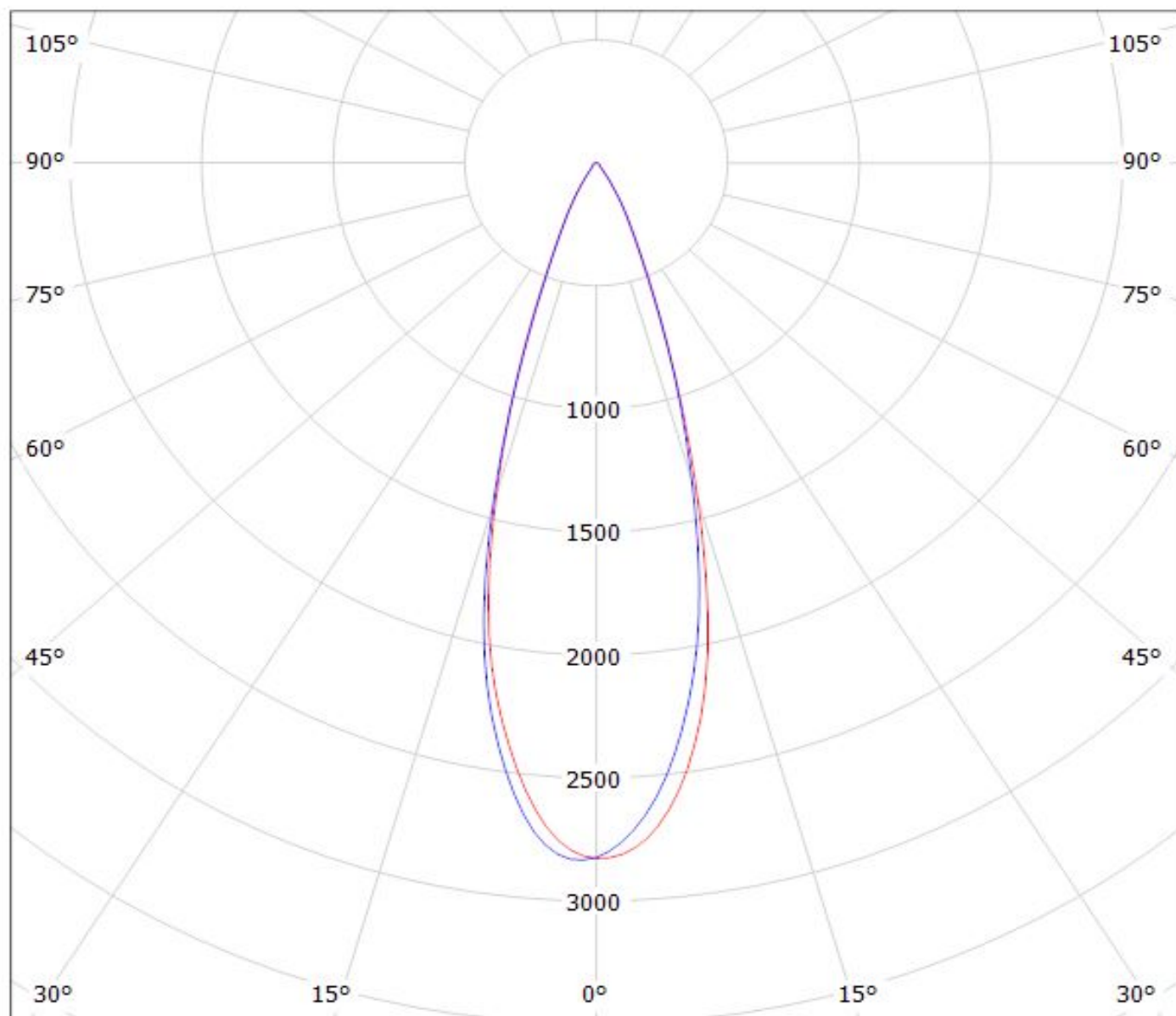

cd/klm

— C0 - C180

— C90 - C270

$\eta = 94\%$

Luminaire: LEDiL Oy C13233_HB-2X2-M_(WICOP2_Z8Y15)

Lamps: 1 x SEOUL_WICOP2_Z8Y15_336.842lm@250mA_P=2.9399W_I=0.250A

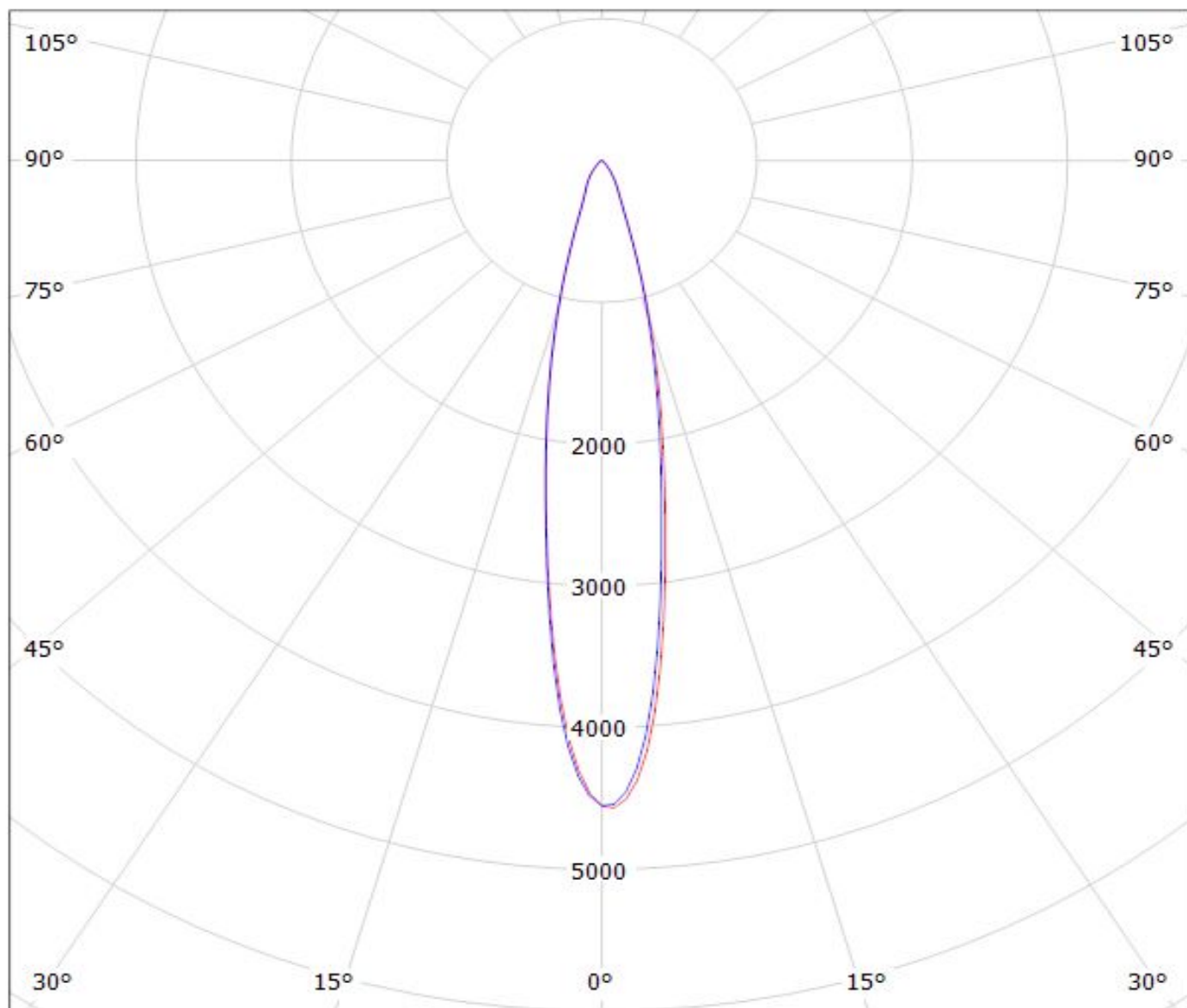

cd/klm

— C0 - C180

— C90 - C270

$\eta = 88\%$

Luminaire: LEDiL Oy C13233_HB-2X2-M_(WICOP2_Z8Y19)

Lamps: 1 x SEOUL_WICOP2_Z8Y19_450.124lm@250mA_P=2.8579W_I=0.250A

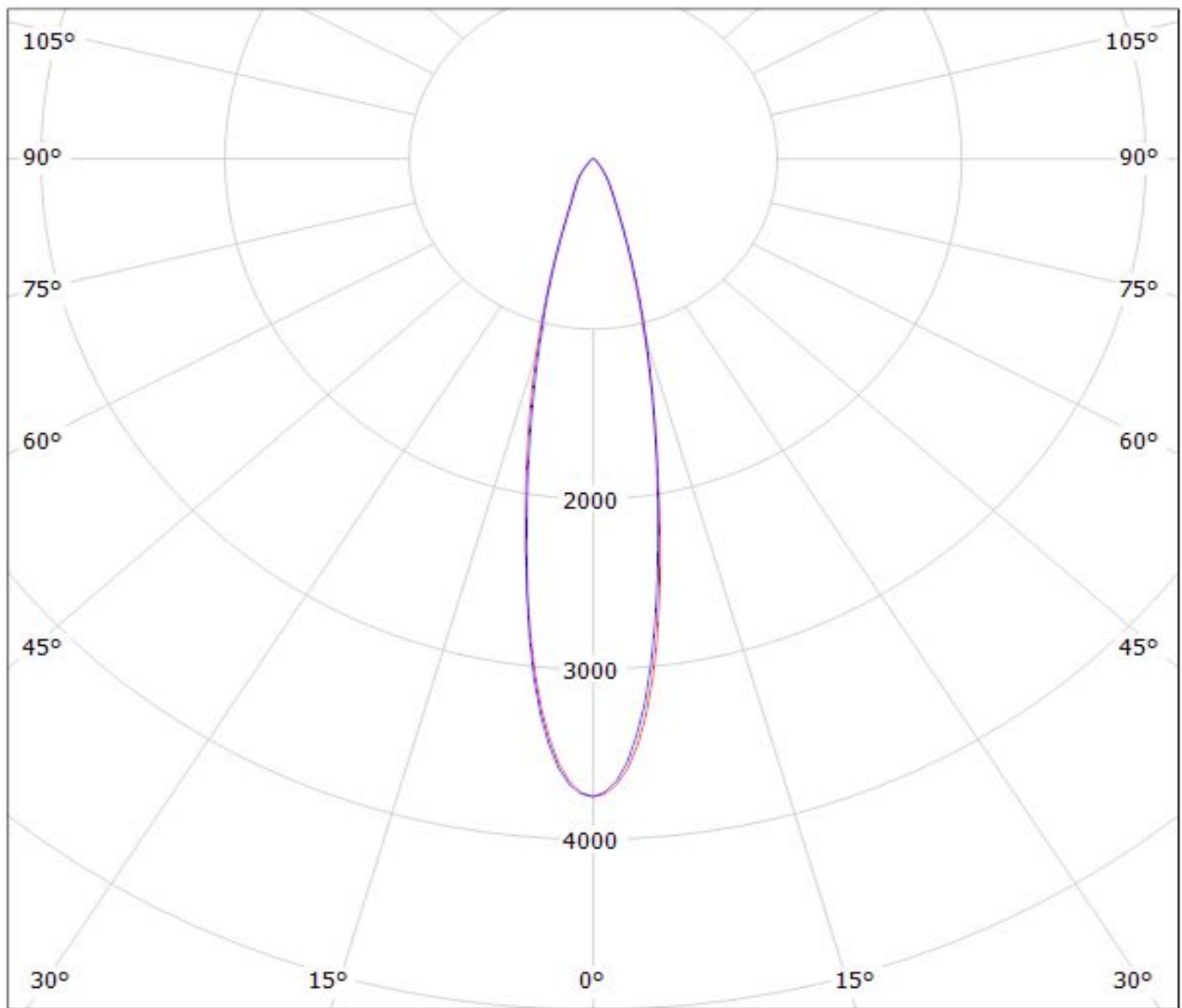

cd/klm

— C0 - C180

— C90 - C270

$\eta = 89\%$

Ledil C13233_HB-2X2-M_(TL1L4) / LDC (Polar)

Luminaire: Ledil C13233_HB-2X2-M_(TL1L4)

Lamps: 1 x Toshiba_TL1L4_2x2_(TL1L4-DW0)_472.639lm@250mA_CCT=6500K_P=2.9W_I=0.25A

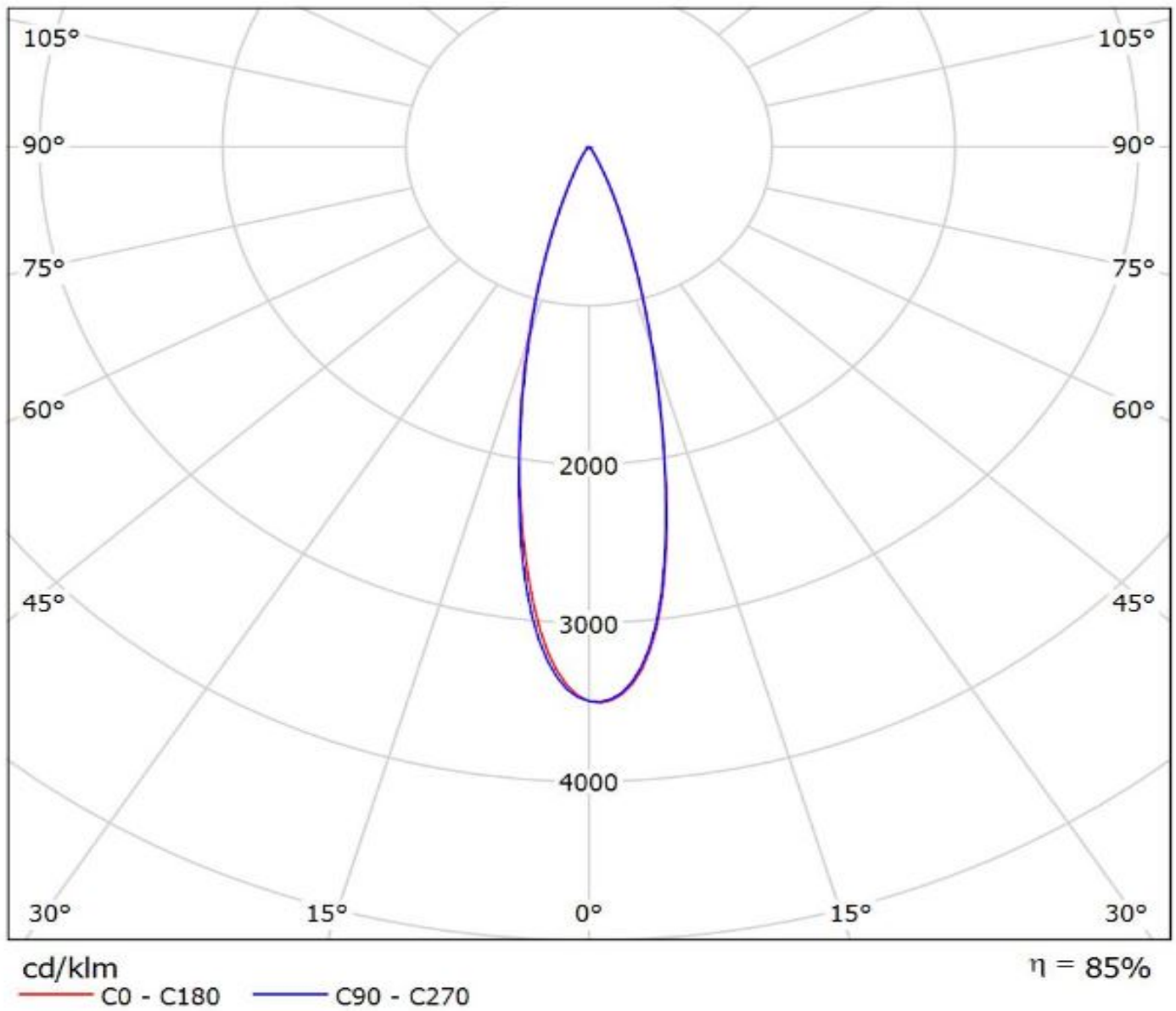

Luminaire: LEDiL Oy C13233_HB-2X2-M (Tridonic Module_RLE_G1)
Lamps: 1 x Tridonic Module_RLE_G1_4576.03lm@700mA_P=32.0681W_I=0.700A

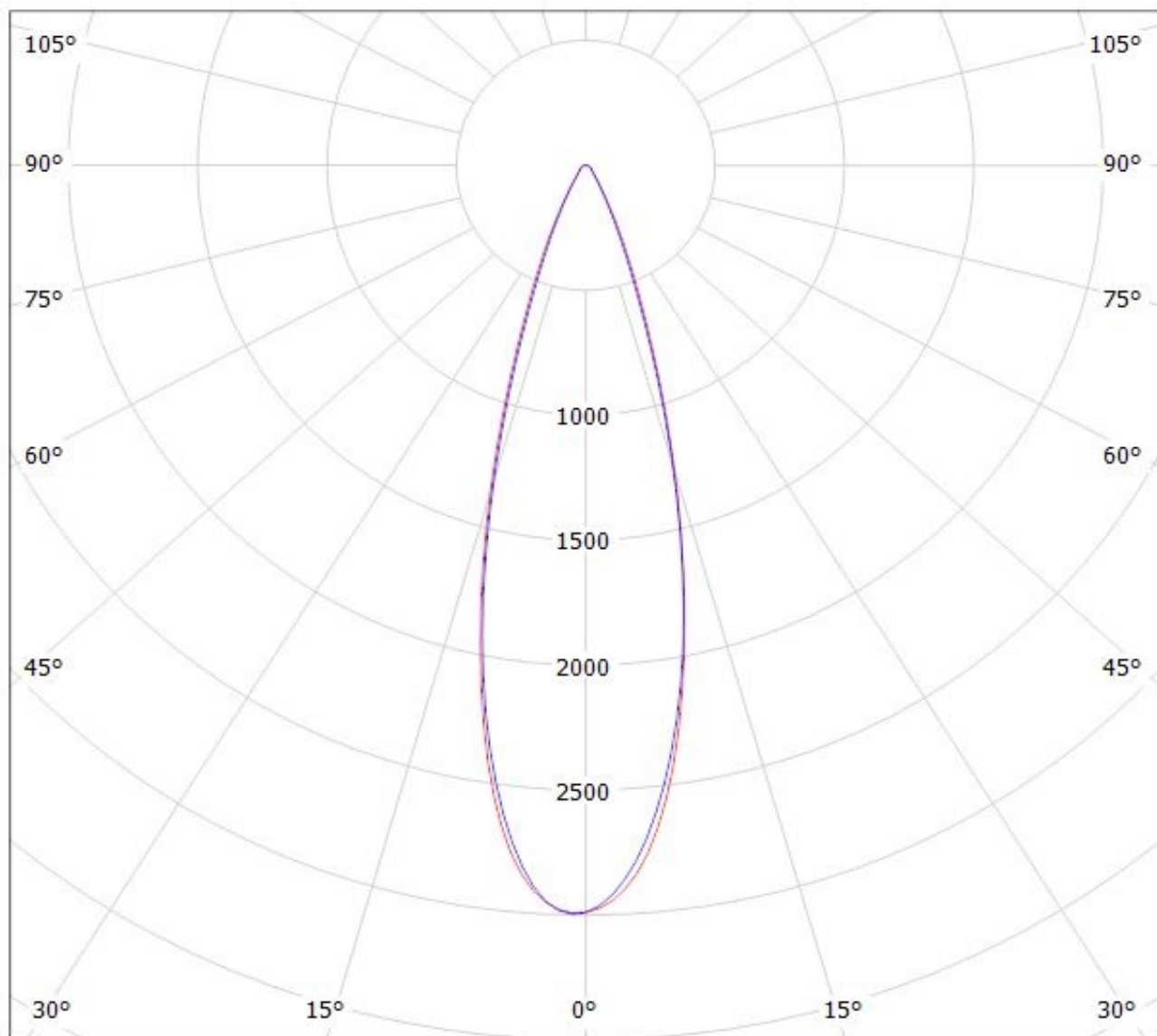

cd/klm

$\eta = 94\%$

— C0 - C180 — C90 - C270

Luminaire: LEDiL Oy C13233_HB-2X2-M (Tridonic Module_RLE_G1)
Lamps: 1 x Tridonic Module_RLE_G1_4576.03lm@700mA_P=32.0681W_I=0.700A

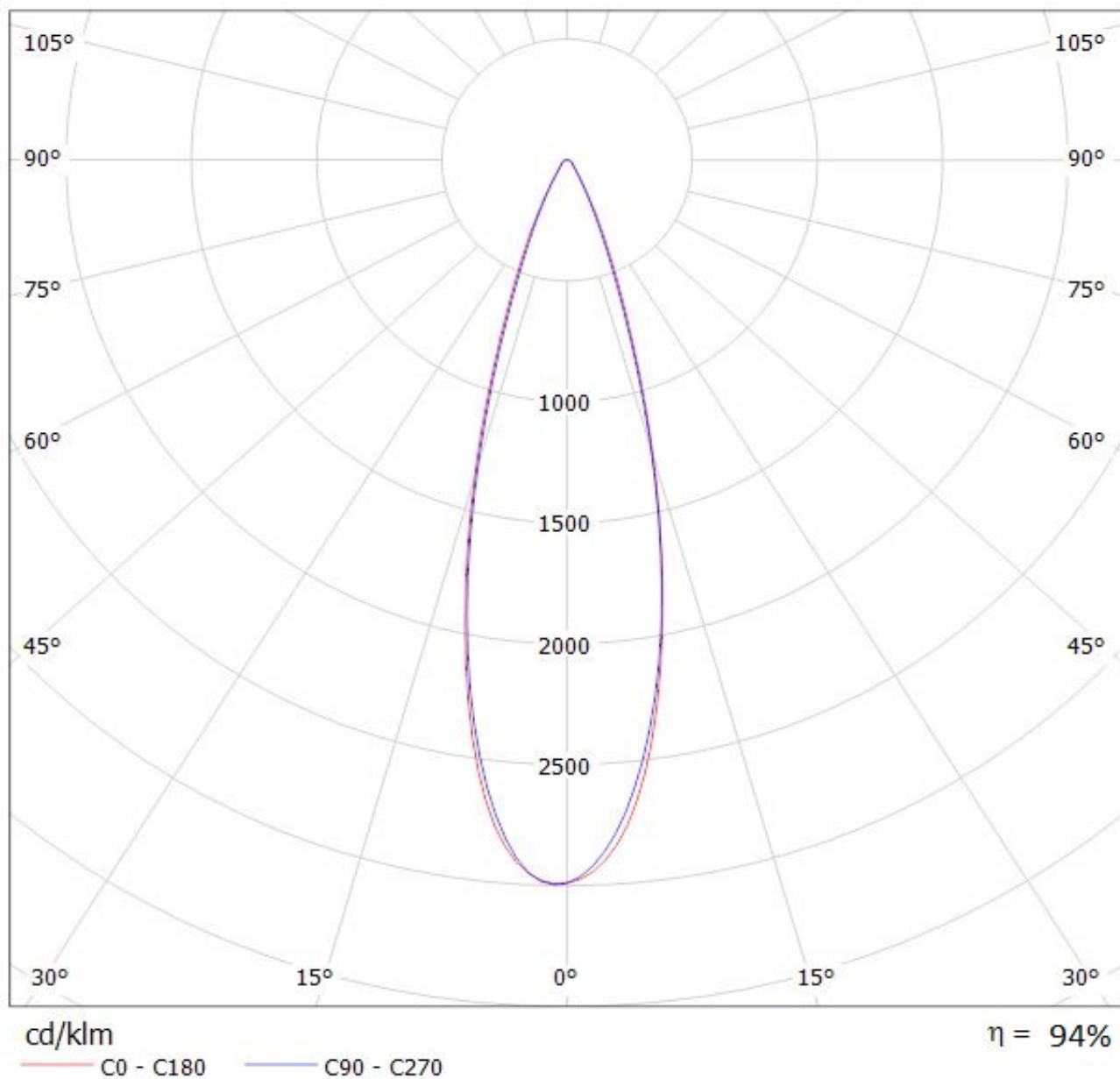

Luminaire: LEDiL Oy C13233_HB-2X2-M_(Tridonic_Module_RLE_G1)
Lamps: 1 x Tridonic_Module_RLE_G1_2288lm@700mA_P=16W_I=0.700A

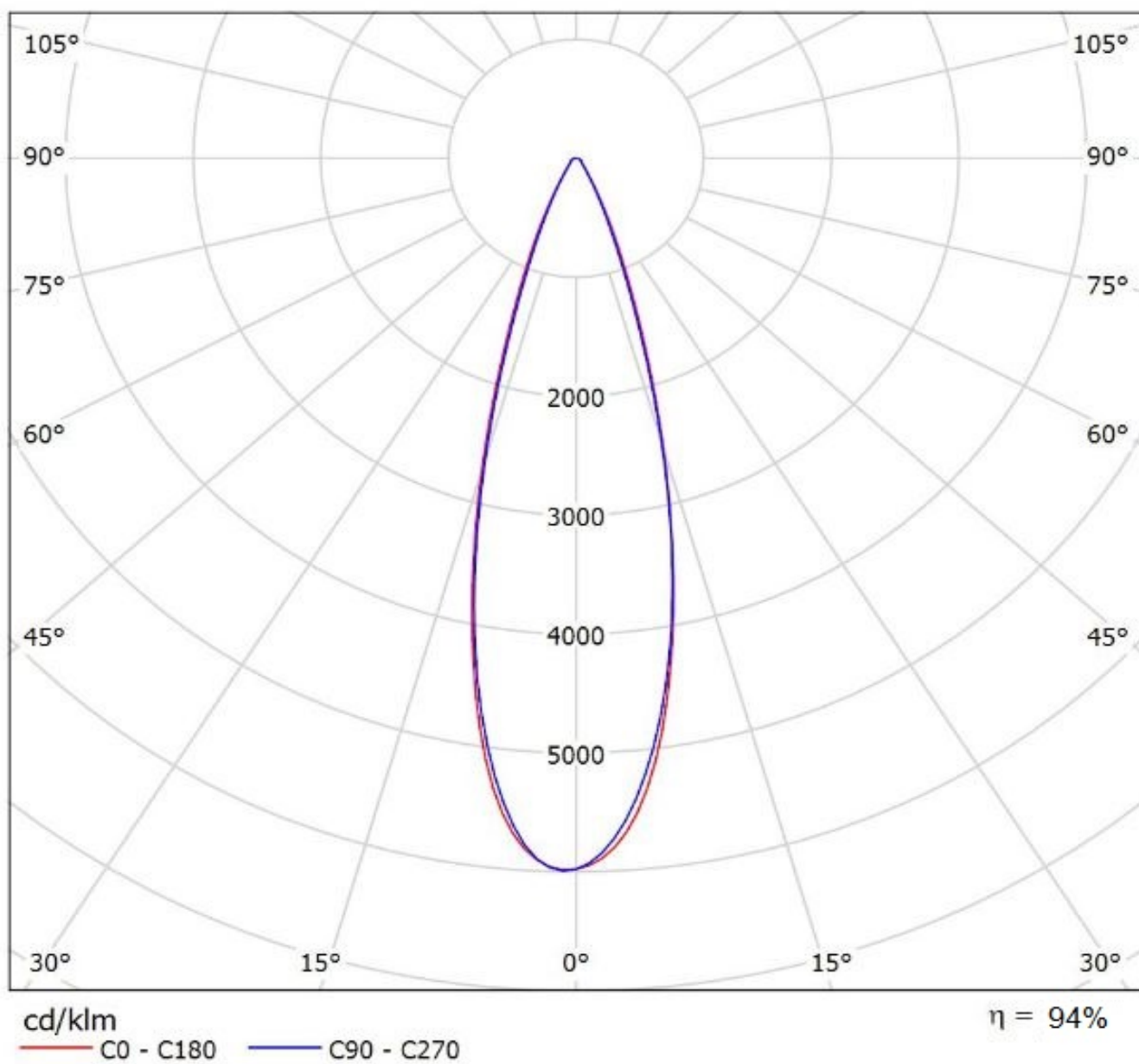

Luminaire: LEDiL Oy C13233_HB-2X2-M_(Tridonic_Module_RLE_G1)
Lamps: 1 x Tridonic_Module_RLE_G1_2288lm@700mA_P=16W_I=0.700A

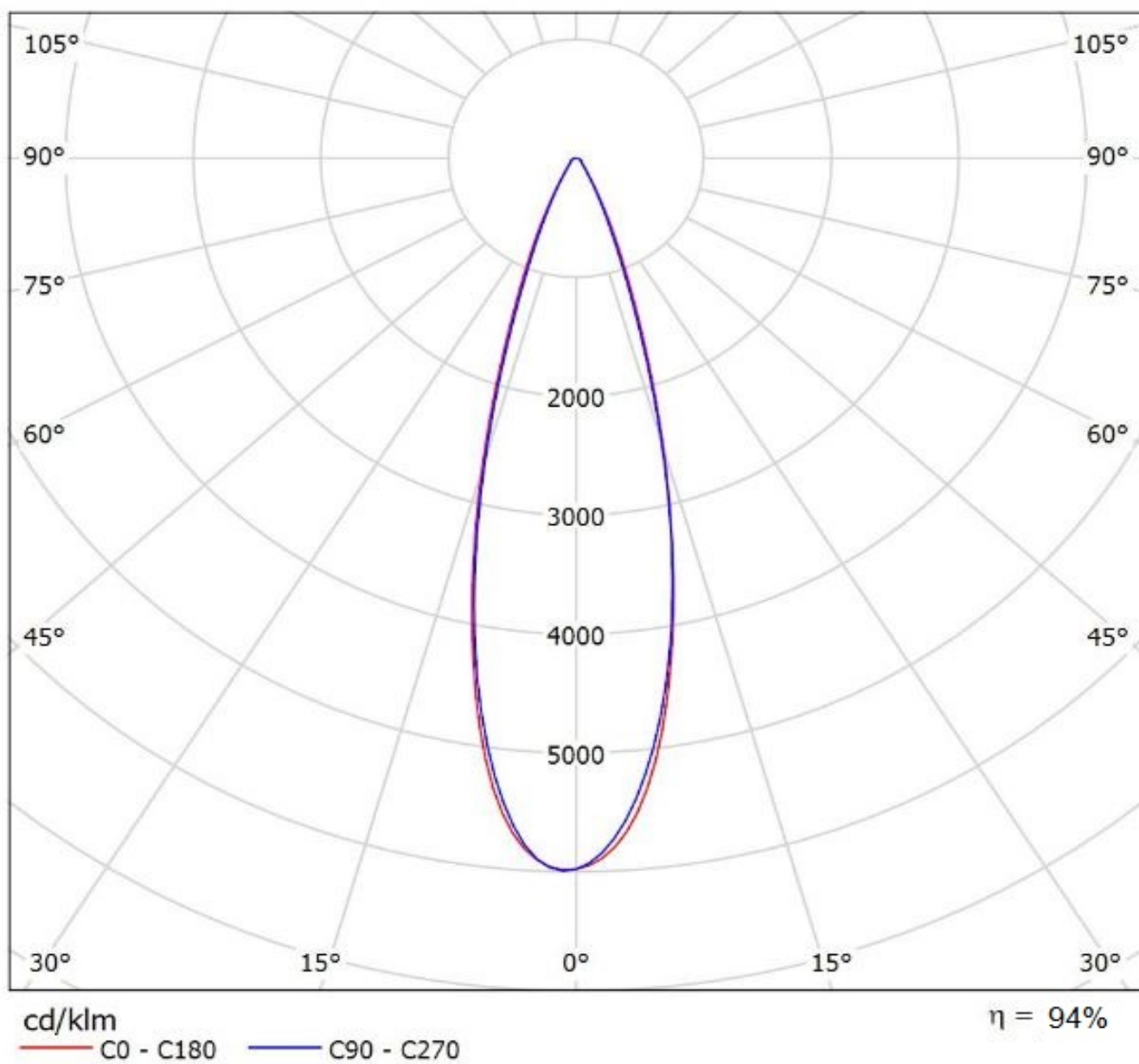

NOTE: The typical divergence will be changed by different color, chip size and chip position tolerance. The typical total divergence is the full angle measured where the luminous intensity is half of the peak value.