

1 2 3 4 5 6

A

B

C

D

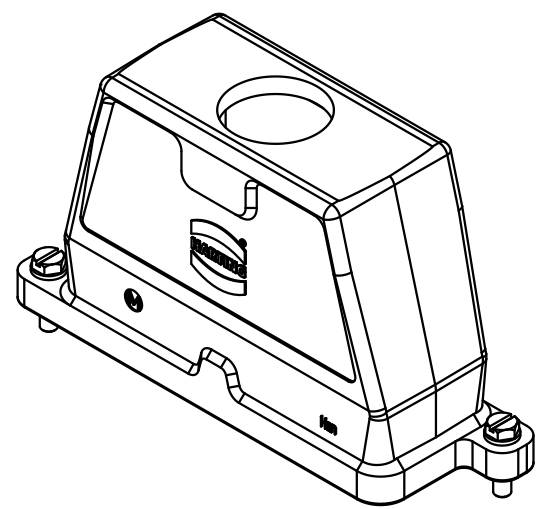
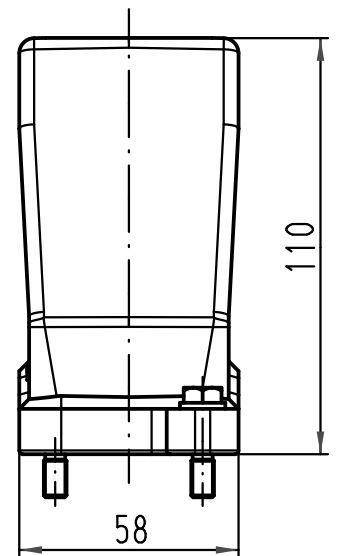
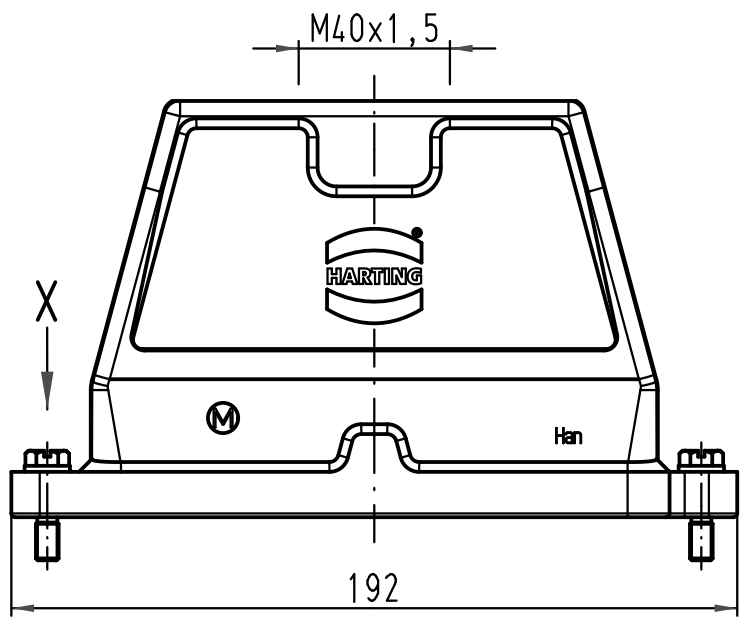
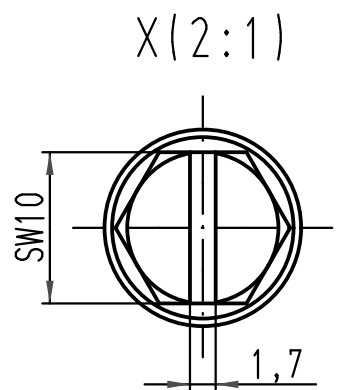

All Dimensions in mm Original Size DIN A 4		Techn. Character.		Nicht tolerierte Maße/Free size tolerances	
			Dat.	Name	Maßstab/Scale 1:2
		Detail.	10.01.11	Ho	
		Insp.		Be	
		Stand.			
A		HARTING Electric GmbH & Co. KG D-32339 Espelkamp			
Mod.	Dat.	Name	TB 19 40 024 0413		Blatt/page
			Sub. TB 19 40 024 0413 v. 14.08.01		