



Application Note: AS3953-AN01 – Demoboard Description

AS3953

NFC interface IC (Tag Demokit)



Table of Contents

1. General Overview	2
1.1. Kit Content	2
1.2. Compatibility	3
2. Hardware Description	4
2.1. Demo Board Description	4
2.1.1. Analog Tag Board Layout (Typical)	5
2.1.1.1. Antenna characterization	6
2.2. BOM	8
2.2.1. Controller board	8
3. Software Description	9
3.1. Demonstration with AS3953 & AS3911	9
3.2. Demonstration with AS3953 & NFC phone (Android 4.0 onwards)	14
Copyright	16
Disclaimer	16

1. General Overview

This application note describes the AS3953 Tag Demo Kit and its usage. The purpose of the demonstrator is to show all the features and functionalities of the IC. The demo works with a reader (Phone or AS3911 GP demonstrator). The main features are:

- Demonstration of a file transfer with different datarates
- Demonstration of passive EEPROM programming via RF Field which then will be read out later when the board is connected and powered – demonstrating ISO14443A-4 compliance
- File and URL transfer (bidirectional) with an NFC phone – demonstrating framing mode

The Demo Kit allows you to supply all components by the PC USB Port. No external supply or battery is needed. Except the USB cable and the flex cable (included), no wiring is needed. This allows a fast and comfortable Demo of the AS3953.

1.1. Kit Content

The AS3953 Tag Demo Kit includes the following items:

- AS3953 Tags (two tags, 25 x 20 mm & 35 x 25 mm)
- Flex cable
- Controller Board with USB interface
- USB Cable
- USB Data Stick

Figure 1:
Package Content

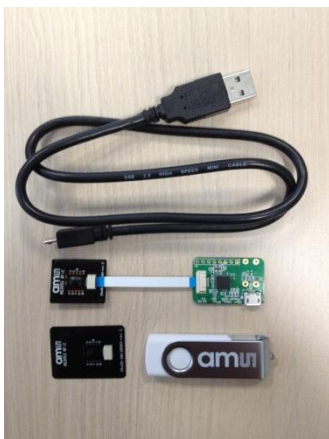



1.2. Compatibility

This demo works with

- AS3953 GP GUI version 3.1.6.0 or higher and FW 3.1.6 or higher
- AS3911 GP GUI version 2.0.18.0 or higher and FW version 2.0.18 or higher
- Google Galaxy Nexus Phone (Android version 4.0 or higher)

2. Hardware Description

2.1. Demo Board Description

The AS3953 demo kit is comprised of 2 boards, the analog tag board and the controller board. The analog tags consist of the AS3953 and an coil antenna. There are the option to mount additional two matching component (one serial and one parallel) on these tags.

Attention: It is necessary to cut the line between the pads of the serial component foot print, if a component should be placed here.

The flex cable connector consists of 8 pins:

P1: VSS/GND

P2: /SS (active low)

P3: SCLK

P4: MOSI

P5: MISO

P6: IRQ

P7: VP_SPI

P8: VP_REG

The controller board mainly consists of the USB connector, PIC27FJ64GB002 and a 8MHz crystal. The board is powered by USB. The above mentioned construct allows:

1. Optional possibility to add another antenna PCB on top
2. a provision to disconnect the on-board micro and connect another micro for the development purpose
3. harvested power measurement with the VP_REG - and GND - pins.

2.1.1. Analog Tag Board Layout (Typical)

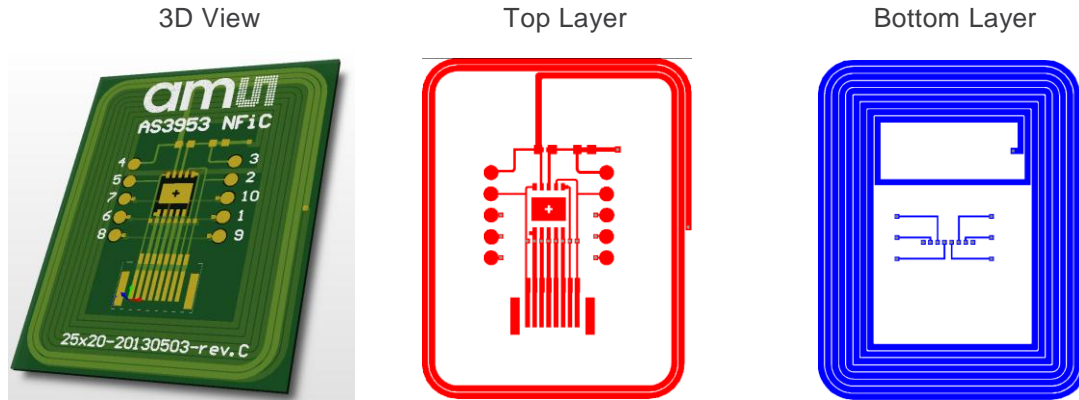

The above pictures show the tag with the dimension 25 x 20 mm. Two bigger tags are also available (35 x 25 mm; 45 x 40 mm):

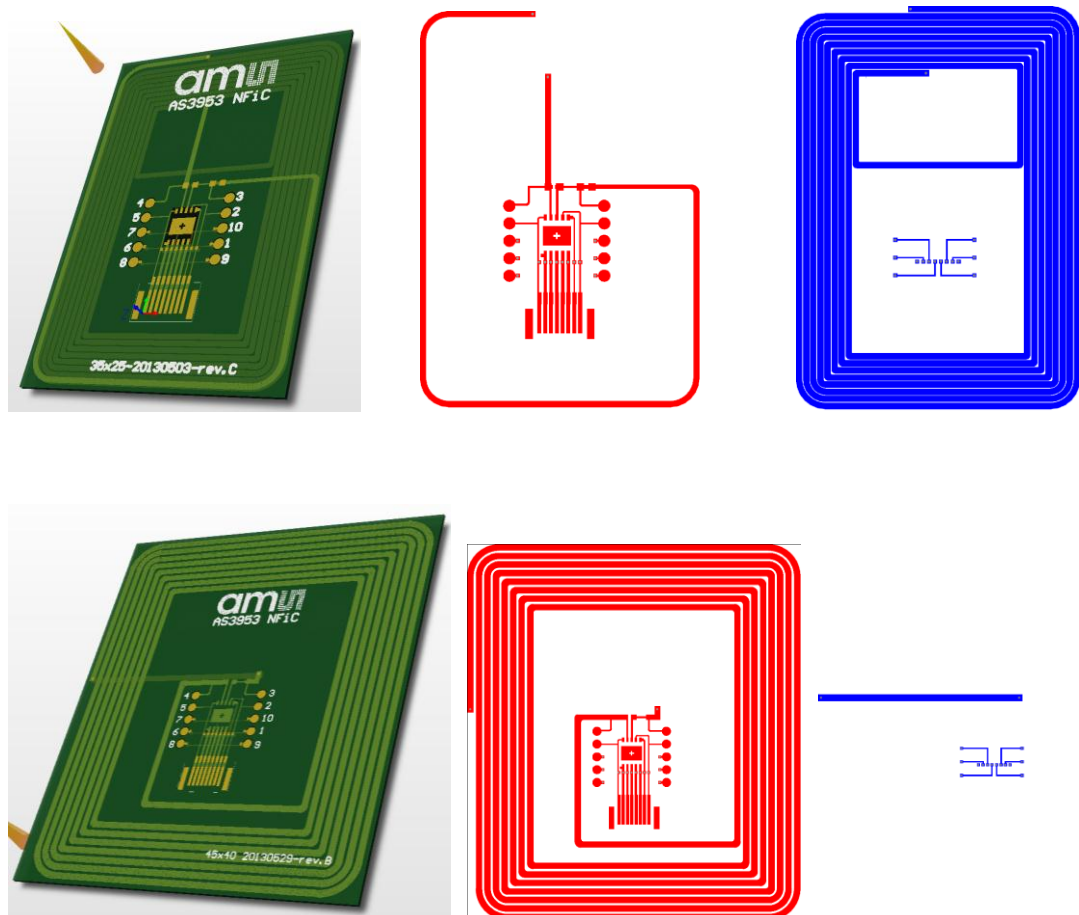

2.1.1.1. Antenna characterization

Tag form factor [mm]	Resonance frequ. @ low power [MHz]	Resonance frequ. @ high power [MHz]	Antenna Q – Factor	System Q - Factor
25 x 20	14,9	14,2	37	14
35 x 25	15	14,2	35	15
45 x 40	15,1	14,2	65	20

Typical measurement results:

Antenna Q – Factor of Tag 25 x 20 mm

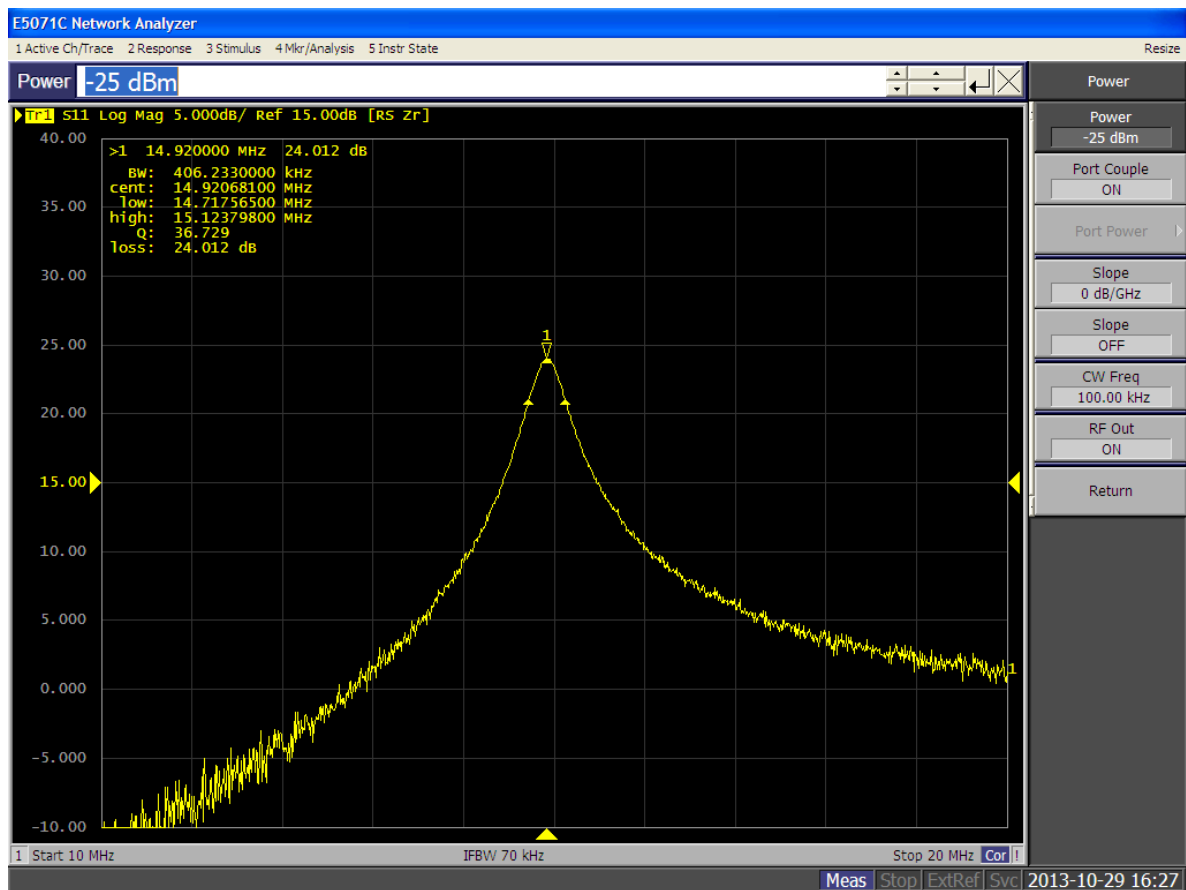

Controller Board Schematic & Layout

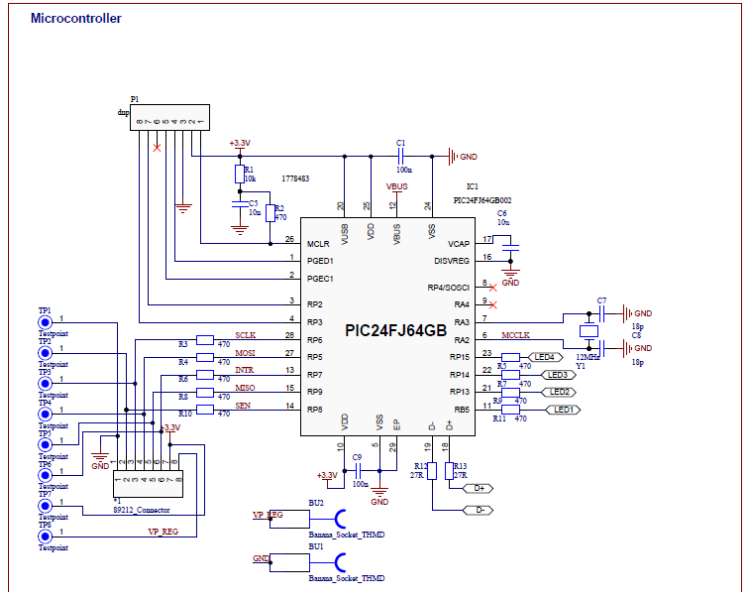
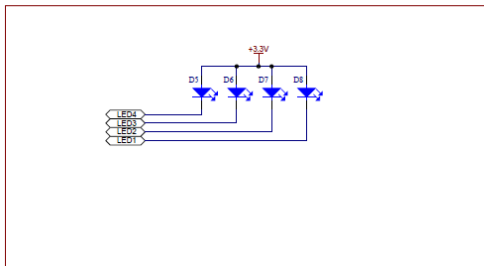
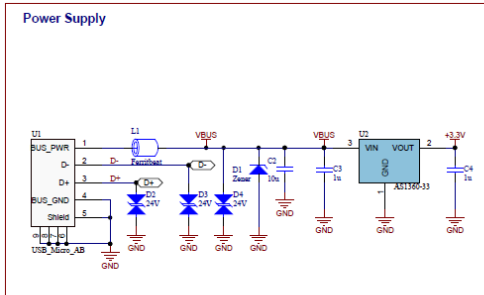

3D View

Top Layer

Bottom Layer

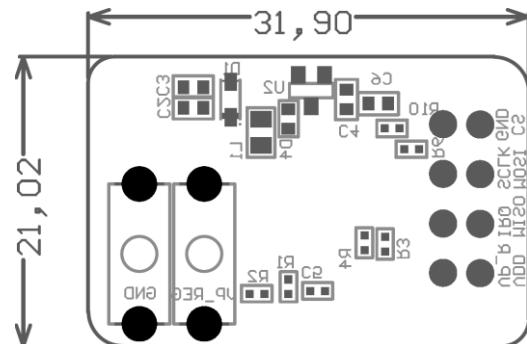
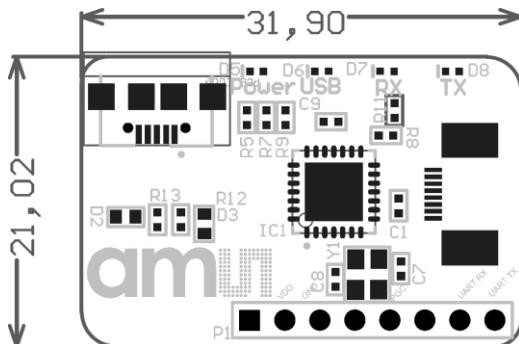
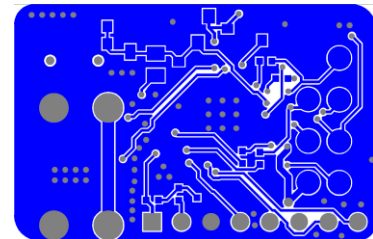
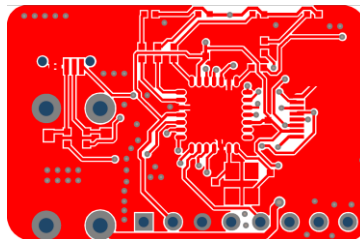
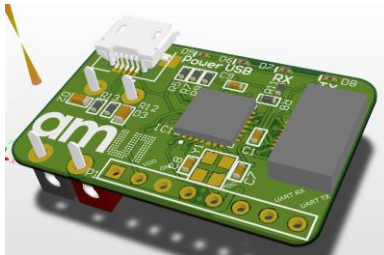



2.2.BOM

2.2.1. Controller board

Bill of Materials			AS3953 Controller Board Small			
Company:		ams AG				
Originator:		mram				
PCB Name:		AS3953 Controller Board Small				
PCB Version:		1.0				
Report Date:		22.02.2013				
#	Designator	Comment	Component_Description	Manufacturer	Manufacturer Part Number	Quantity
1	*1	89212_Connector	TE CONNECTIVITY / AMP -	TE CONNECTIVITY / AMP	1734592-8	1
2	BU1, BU2	Banana_Socket_THMD	HIRSCHMANN TEST AND	HIRSCHMANN TEST AND	PB4 BLACK, PB4 RED	2
3	C1, C9	100n	MULTICOMP - MCCA000512	MULTICOMP	MCCA000512	2
4	C2, C6	10u	TDK -	TDK	C1608X5R1A106K080AC	2
5	C3, C4	1u	KEMET -	KEMET	C0603C105K9RACTU	2
6	C5	10n	MULTICOMP - MCCA000040	MULTICOMP	MCCA000040	1
7	C7, C8	18p	MULTICOMP - MCCA000097	MULTICOMP	MCCA000097	2
8	D1	Zener	ON SEMICONDUCTOR -	ON SEMICONDUCTOR	MM3Z6V8T1G	1
9	D2, D3, D4	24V	COOPER BUSSMANN -	COOPER BUSSMANN	0603ESDA-TR1	3
10	D5, D6, D7, D8	LED_LUMEX	LED BLUE 470NM WTR	Kingbright Corp	ARHHS1005QBCD	4
11	IC1	PIC24FJ64GB002	MICROCHIP -	MICROCHIP	PIC24FJ64GB002-IML	1
12	L1	Ferritbeat	FAIR-RITE - 2508051107Y0	FAIR-RITE	2508051107Y0	1
13	P1	dnp				1
14	R1	10k	TE CONNECTIVITY -	TE CONNECTIVITY	CRG0402J10K	1
15	R2, R3, R4, R5, R6, R7, R8, R9,	470	MULTICOMP -	MULTICOMP	MCMR04X4700FTL	10
16	R12, R13	27R	YAGEO (PHYCOMP) -	YAGEO (PHYCOMP)	RC0402FR-0727RL	2
17	TP1, TP2, TP3, TP4, TP5, TP6,	Testpoint				8
18	U1	USB_Micro_AB	CONN RCPT MICRO USB AB	Hirose Electric Co Ltd	ZX62-AB-5PA(11)	1
19	U2	AS1360-33	IC REG LDO 3.3V .15A	ams	AS1360-33-T	1
20	Y1	12MHz	TXC - 7M-12.000MAAJ-T -	TXC	7M-12.000MAAJ-T	1
Approved			Notes			47

3. Software Description

AS3953 demo kit behaves like a 14443A-4 Tag. It can be used with AS3911 GP board (Reader) or a standard NFC phone. We have defined Google Galaxy Nexus as our reference mobile phone (Android version 4.0 or higher).

The SW can be downloaded from the following destinations:

	Software download to:	FTP side	User	password
AS3911G P_GUI	General Purpose Demo GUI	http://www.space4ams.at/user/AS3911GP_GUI/default.php	GPgui	hgewdt3
AS3953 GUI	General purpose	http://www.space4ams.at/user/AS3953_GUI/default.php	as3953_gui	rtvzi3

3.1.Demonstration with AS3953 & AS3911

- Connect AS3911 GP demo and AS3953 GP demo with the USB to the computer and start the respective GUIs
- AS3911 FW version must be 2.0.18 or higher
- Click on “Demo Board Check”, “Adjust Regulator” and “Calibrate Antenna” to configure the board.

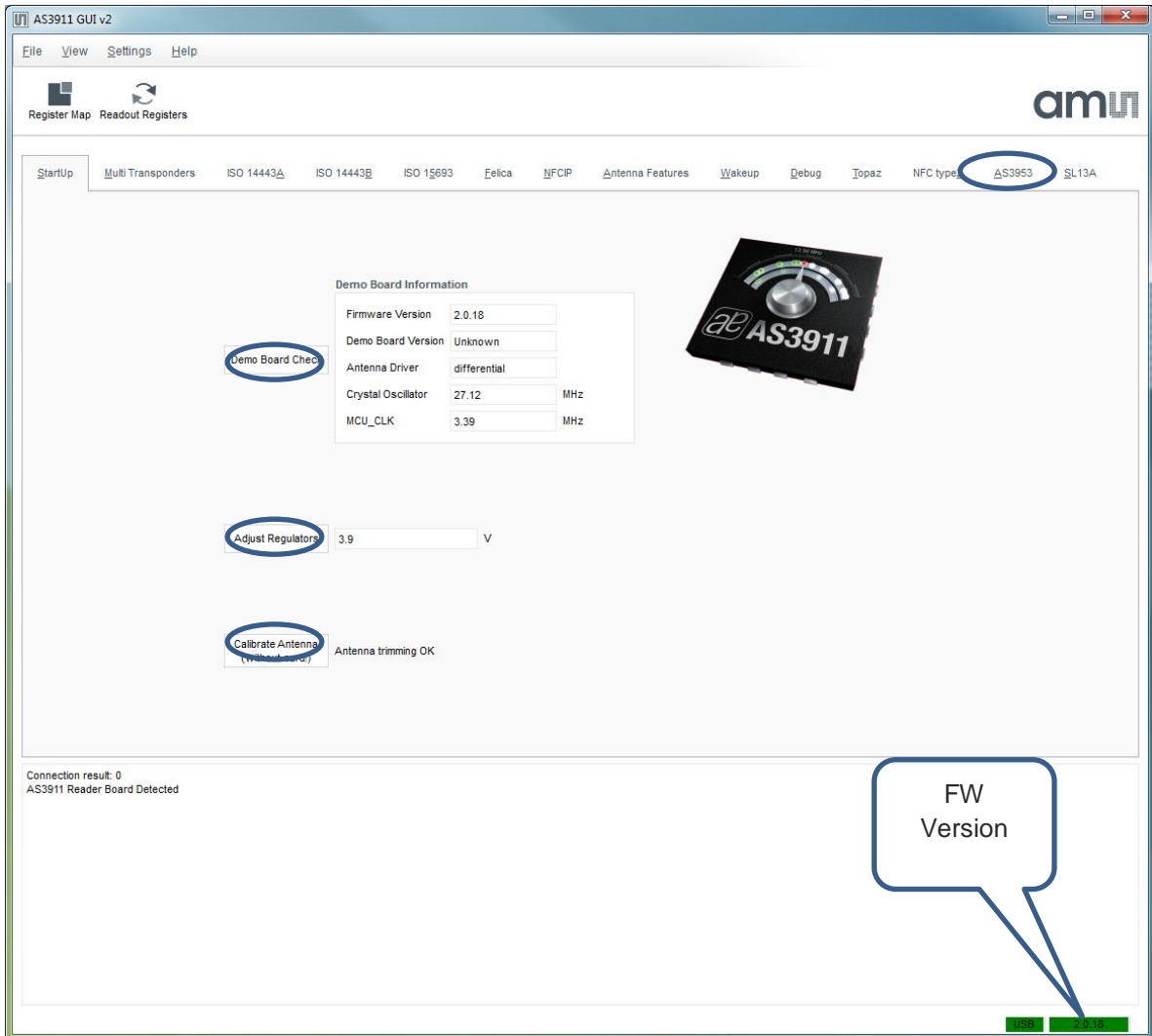

- AS3911 GUI version must be 2.0.18.0 or higher

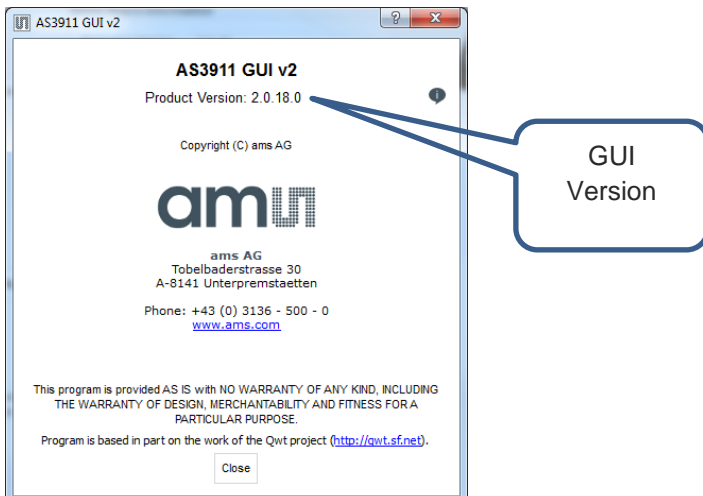

- AS3953 FW version must be 3.1.6 or higher

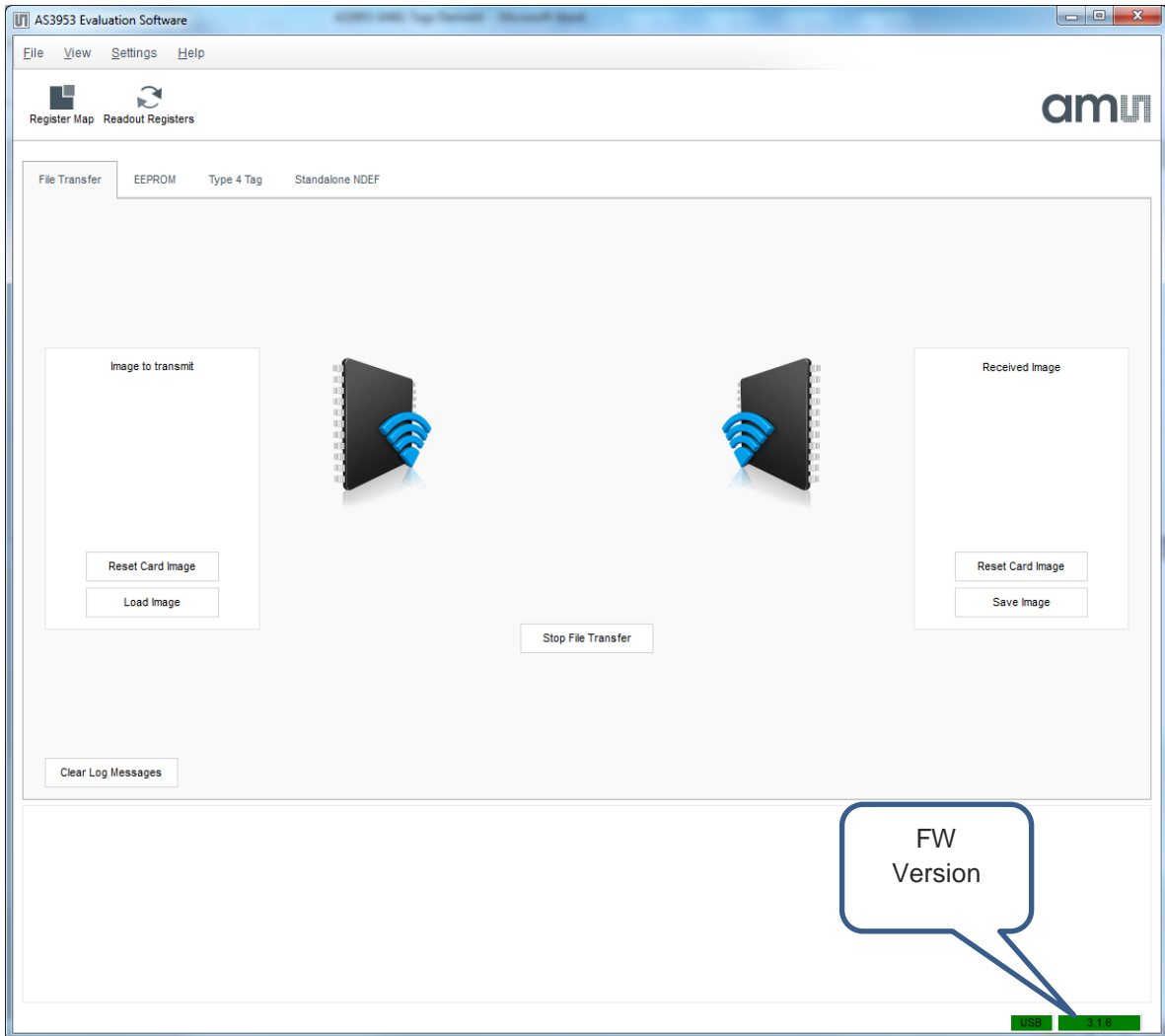

- AS3953 GUI version must be 3.1.6.0 or higher

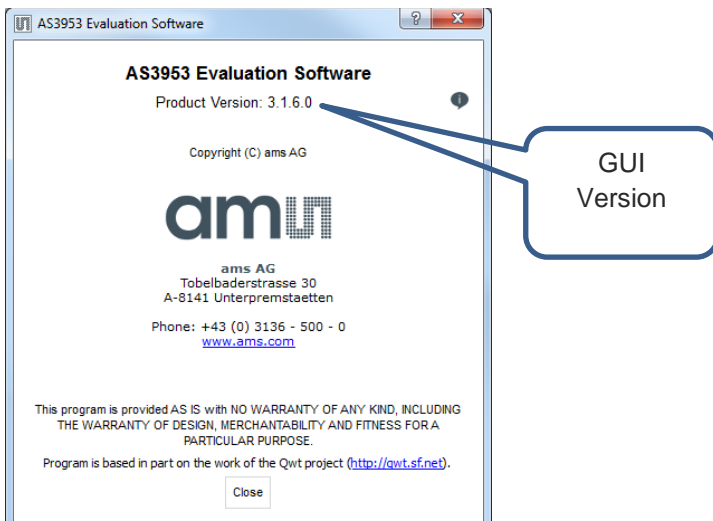



- To transmit from AS3911 (Reader) to AS3953(NFiC):
On AS3911 GUI select “load image”, select “speed settings” and click on “Write to Card” to execute the file transfer. NOTE: do not forget to keep the AS3953 antenna on AS3911 antenna.
- To transmit from AS3953(NFiC) to AS3911 (Reader):
On AS3953 GUI select “load Image”. On AS3911 GUI, select “speed settings” and click on “Read from Card” to execute the file transfer.
- EEPROM Read/write (from RF Field):
This can be done passively. Disconnect the analog tag board from the controller board so that it is not powered. Place it on the top of the AS3911. Use the GUI sub-tab in the AS3953 tab of AS3911 GUI. Click on “Read EEPROM” and see the config bit changing. The EEPROM can be written by just changing the values here. NOTE: be aware of the effects while writing address 3 and 4.

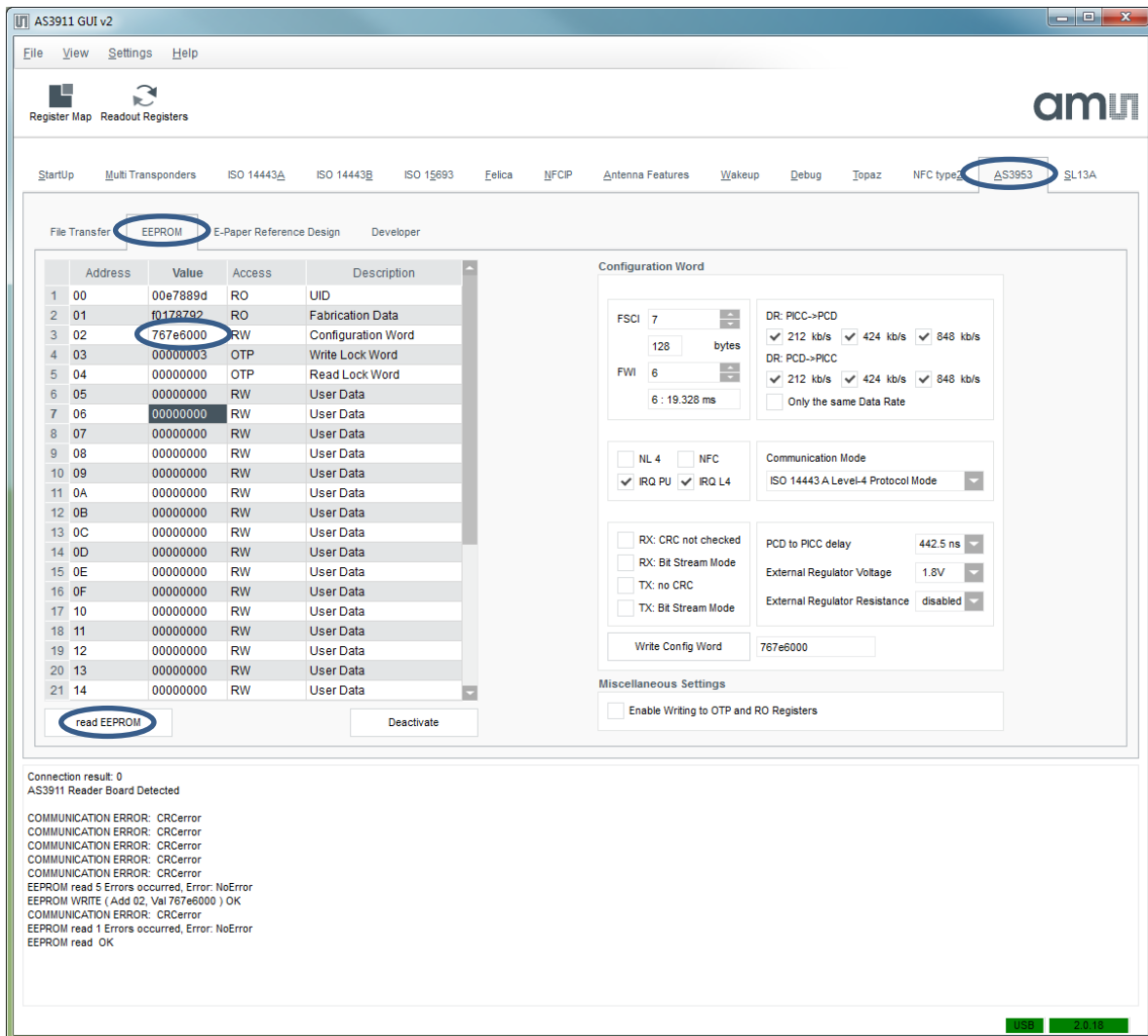



- EEPROM Read/write (from MCU):
Now connect this Analog tab board to the controller board and connect it to the GUI via USB. The EEPROM tab in the AS3953 GUI can be used to read/write out the EEPROM content when the AS3953 is not in the field.

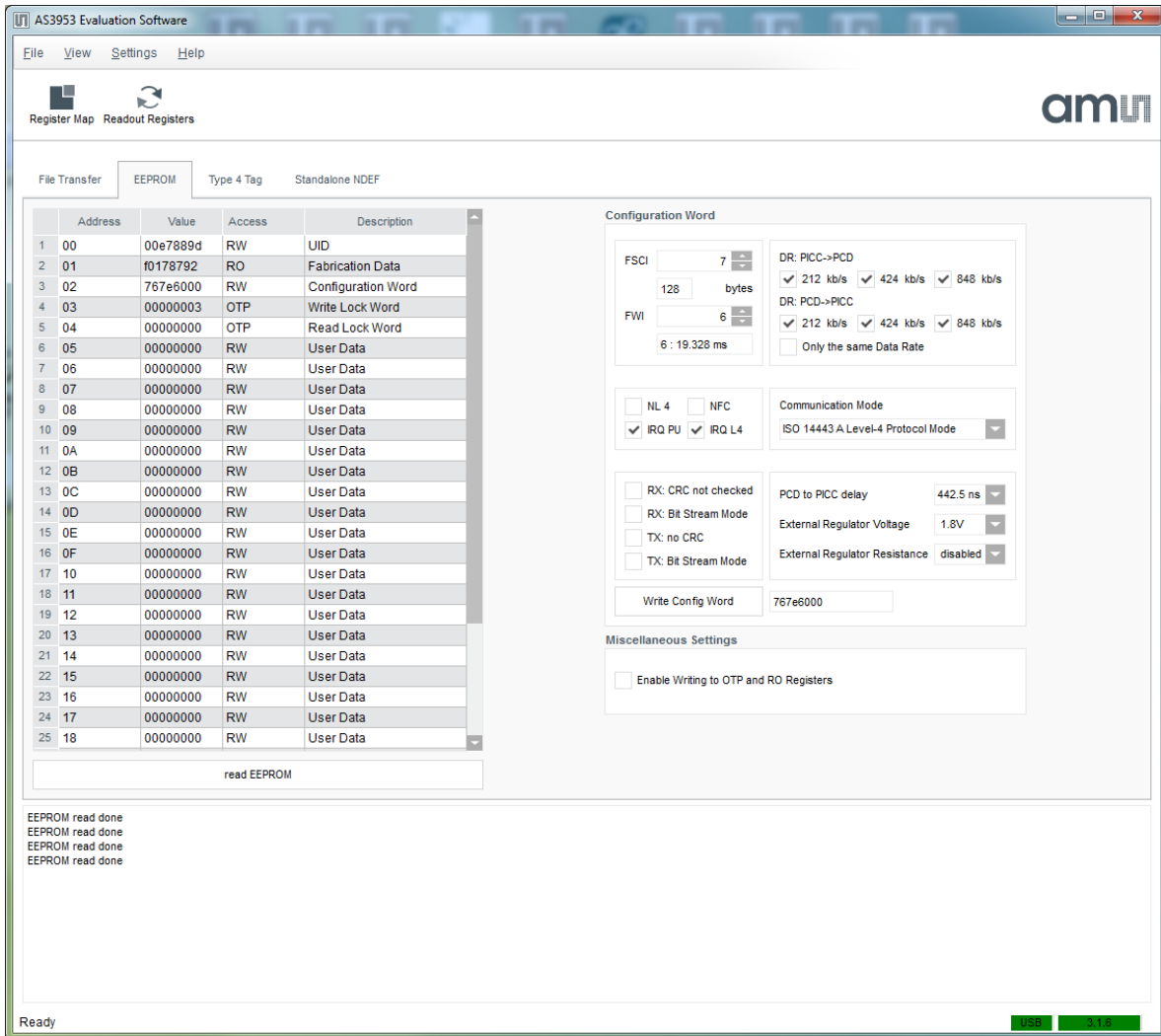

3.2. Demonstration with AS3953 & NFC phone (Android 4.0 onwards)

The NFC FW in the PIC MCU has been written such that it sends and receives the NDEF messages. Hence no special app is required to send a message to a standard NFC phone. Nevertheless, we have developed an app to send info from phone to the AS3953 GP demo.

- Move to Type 4 Tag tab in the AS3953 GUI and install the provided android app on the NFC phone.
- File/URL Transfer from GUI to Phone:
Select an image or URL which needs to be transferred to phone. Selected option should show up in the right side of the GUI. Now just unlock the phone and place it on the AS3953 GP demo antenna. Note: The filesize is limited to 64Kbit (limited by NDEF message framework)

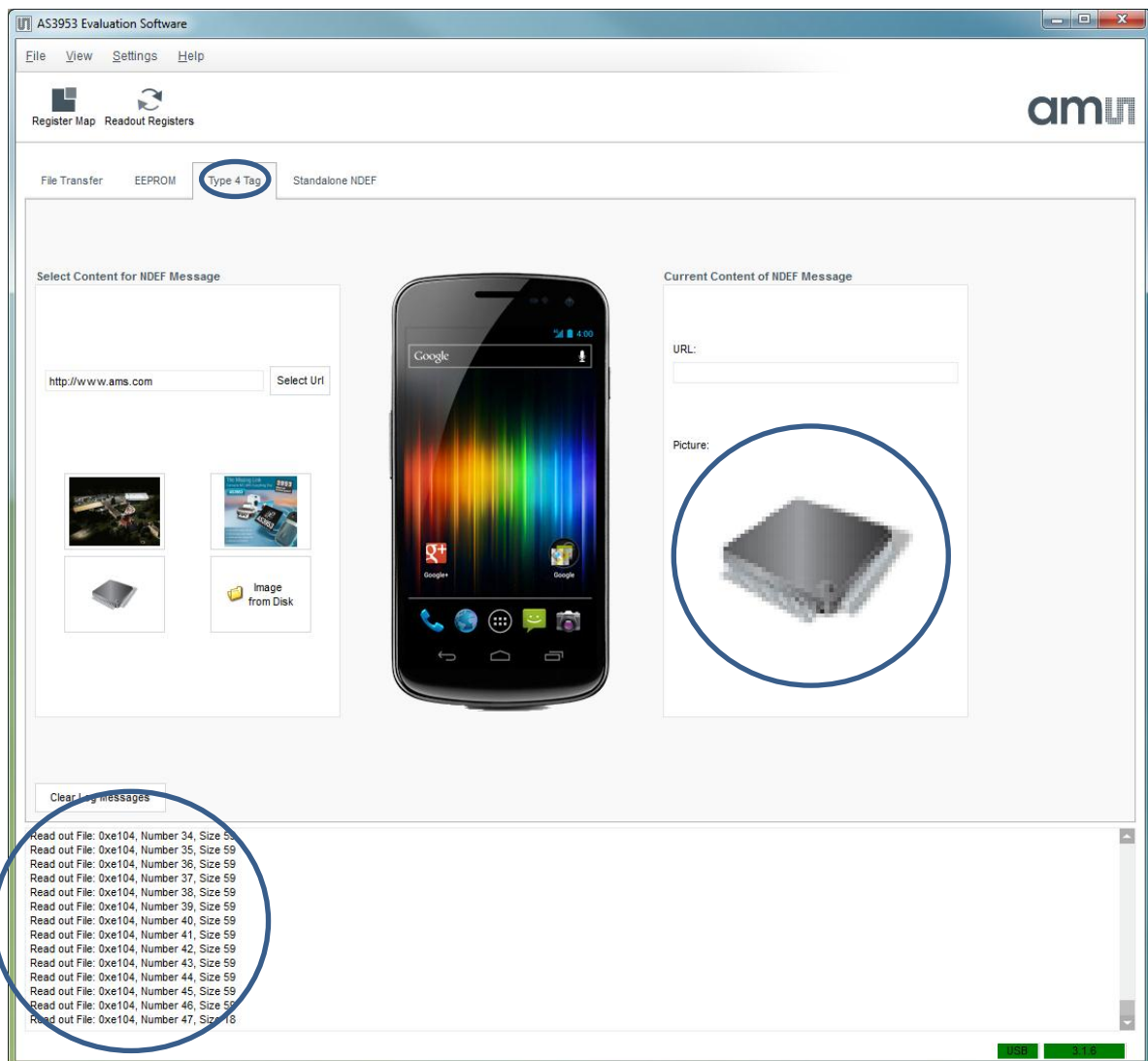

- File/URL Transfer from GUI to Phone:
open the amsNFC app and click on “Transfer Image” or “Transfer URL”. Select an image or URL respectively and place the phone on the AS3953 GP demo antenna. The file transfer starts automatically.

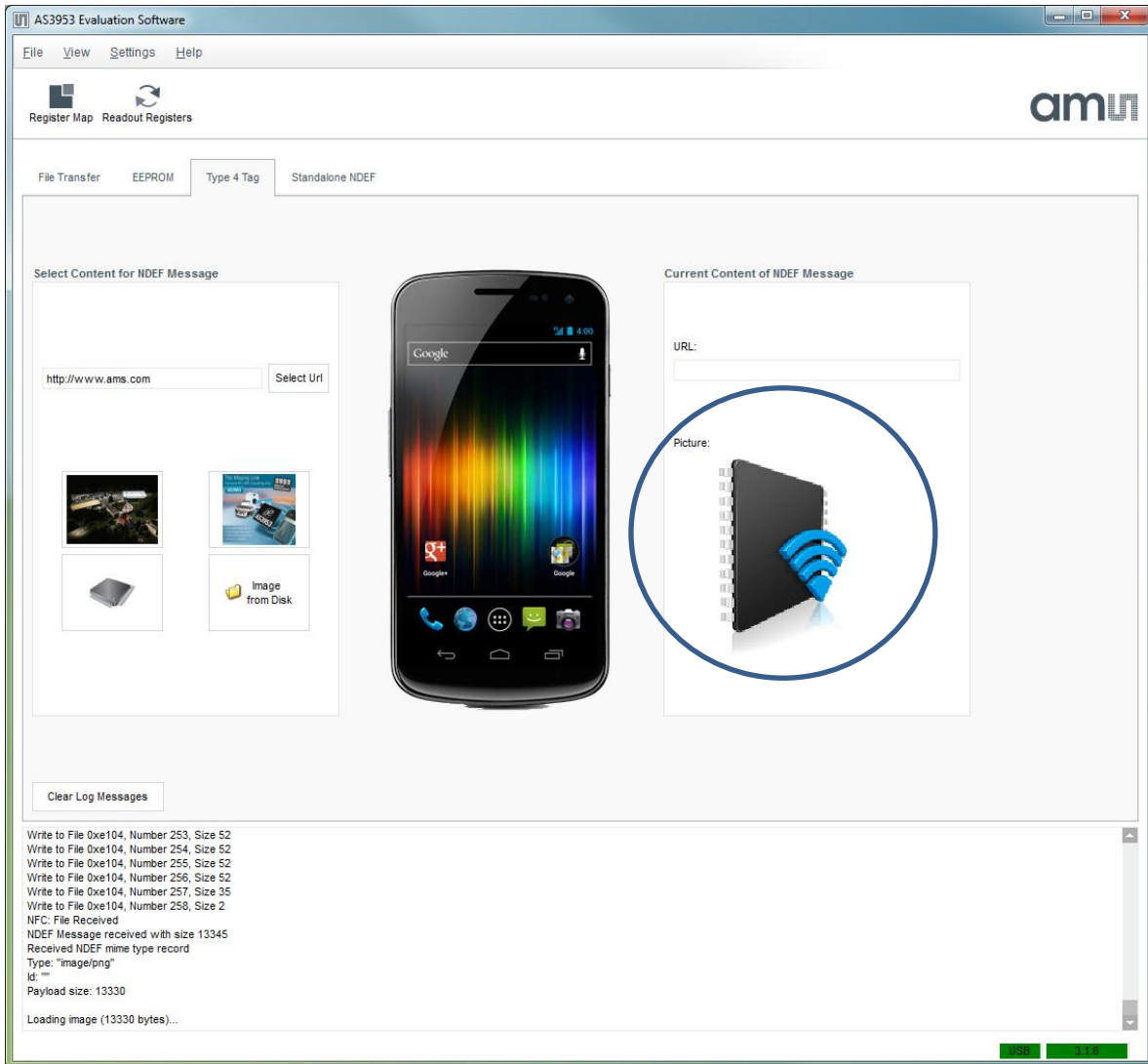

Copyright

Copyright © 1997-2012, ams AG, Tobelbader Strasse 30, 8141 Unterpremstaetten, Austria-Europe. Trademarks Registered ®. All rights reserved. The material herein may not be reproduced, adapted, merged, translated, stored, or used without the prior written consent of the copyright owner.

All products and companies mentioned are trademarks or registered trademarks of their respective companies.

Disclaimer

Devices sold by ams AG are covered by the warranty and patent indemnification provisions appearing in its Term of Sale. ams AG makes no warranty, express, statutory, implied, or by description regarding the information set forth herein or regarding the freedom of the described devices from patent infringement. ams AG reserves the right to change specifications and prices at any time and without notice. Therefore, prior to designing this product into a system, it is necessary to check with ams AG for current information.

This product is intended for use in normal commercial applications. Applications requiring extended temperature range, unusual environmental requirements, or high reliability applications, such as military, medical life-support or lifesustaining equipment are specifically not recommended without additional processing by ams AG for each application. For shipments of less than 100 parts the manufacturing flow might show deviations from the standard production flow, such as test flow or test location.

The information furnished here by ams AG is believed to be correct and accurate. However, ams AG shall not be liable to recipient or any third party for any damages, including but not limited to personal injury, property damage, loss of profits, loss of use, interruption of business or indirect, special, incidental or consequential damages, of any kind, in connection with or arising out of the furnishing, performance or use of the technical data herein. No obligation or liability to recipient or any third party shall arise or flow out of ams AG rendering of technical or other services.

Contact Information

Headquarters

ams AG
Tobelbader Strasse 30
8141 Unterpremstaetten
Austria
T. +43 (0) 3136 500 0
For Sales Offices, Distributors and Representatives, please visit:
<http://www.ams.com/contact>